

New Methods in Urban Analysis and Simulation

Reinhard König, Estefania Tapias, and Gerhard Schmitt

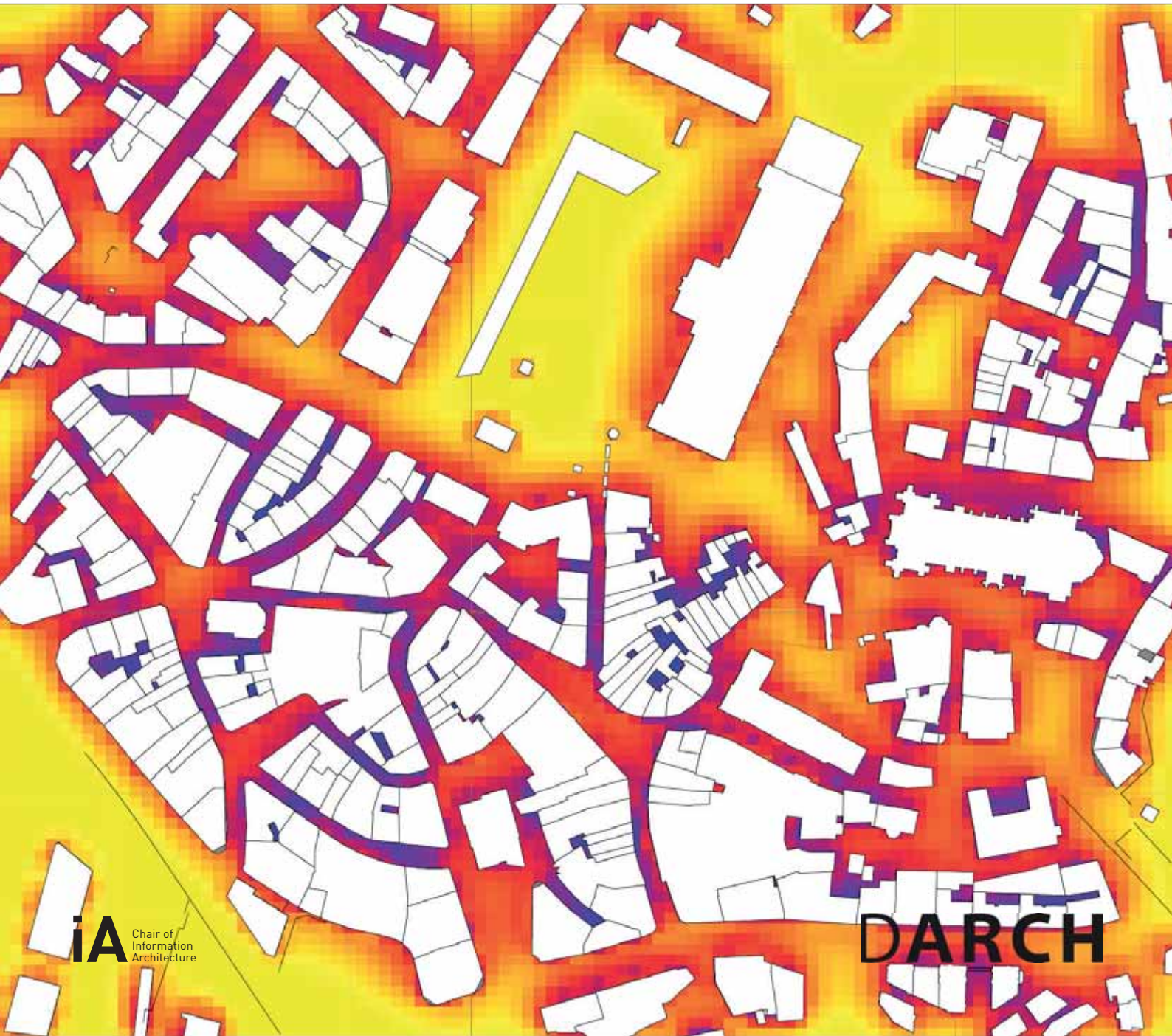

DARCH

Department of Architecture

Chair of Information Architecture

New Methods in Urban Analysis and Simulation

Documentation of teaching results

Reinhard König, Estefania Tapias, and Gerhard Schmitt



Chair of Information Architecture

Teaching

Reinhard König, Estefania Tapias, and Gerhard Schmitt

Syllabi

<http://www.ia.arch.ethz.ch/category/teaching/hs2013-new-methods-in-urban-analysis-and-simulation/>

Seminar

New Methods in Urban Analysis and Simulation

Students

Philipp Sax, Michael Bühler, Lino Moser, Felix Ledergerber,
Doan T. D. Tom, Dzenis Dzihic, Hugo Decramer

Published by

Swiss Federal Institute of Technology in Zurich (ETHZ)
Department of Architecture
Chair of Information Architecture
Wolfgang-Pauli-Strasse 27, HIT H 31.6
8093 Zurich
Switzerland

Zurich, December 2014

Contact

reinhard.koenig@arch.ethz.ch | <http://www.ia.arch.ethz.ch/koenig/>

Cover picture:

Front side: Doan T. D. Tom, yearly solar access for the place de la Riponne in the city of Lausanne

Back side: Doan T. D. Tom, shadow range 21st of June for the place de la Riponne in the city of Lausanne

Content

Channel - Fann Hock, Dakar

Students: Philipp Sax, Michael Bühler

p.6

The Airport Backyard

Students: Lino Moser, Felix Ledergerber

p.22

Riponne Maurice Béjart: An Urban Premise

Student: Doan T. D. Tom

p.36

Basel Mosque

Students: Dzenis Dzihic, Hugo Decramer

p.48

Channel - Fann Hock, Dakar

Students: Philipp Sax, Michael Bühler

Dakar is one of the biggest cities in West Africa. Like most coastal cities Dakar is affected by the sea and it's benefits like the intercontinental trade, which was the main cause of Dakar's urban growth in the 20th century. For this reason the bigger part of the building stock is relatively new and often built precipitous without a specific strategy.

One of these younger expansions was the district of Fann Hock. The expansion was started in 1945 and is by now a dense district which possesses a relatively high technical standard. However, the main problem of the district is the missing quality of infrastructure, which is embodied in the open sewage water channel. Besides the obvious problems the channel also acts as a barrier, that disconects Fann Hock from the other districts.

In our research we analysed Fann Hock in terms of interactions to the other districts and thereby we tried to find places with the highest capability of improvement.



Fann Hock - Street View

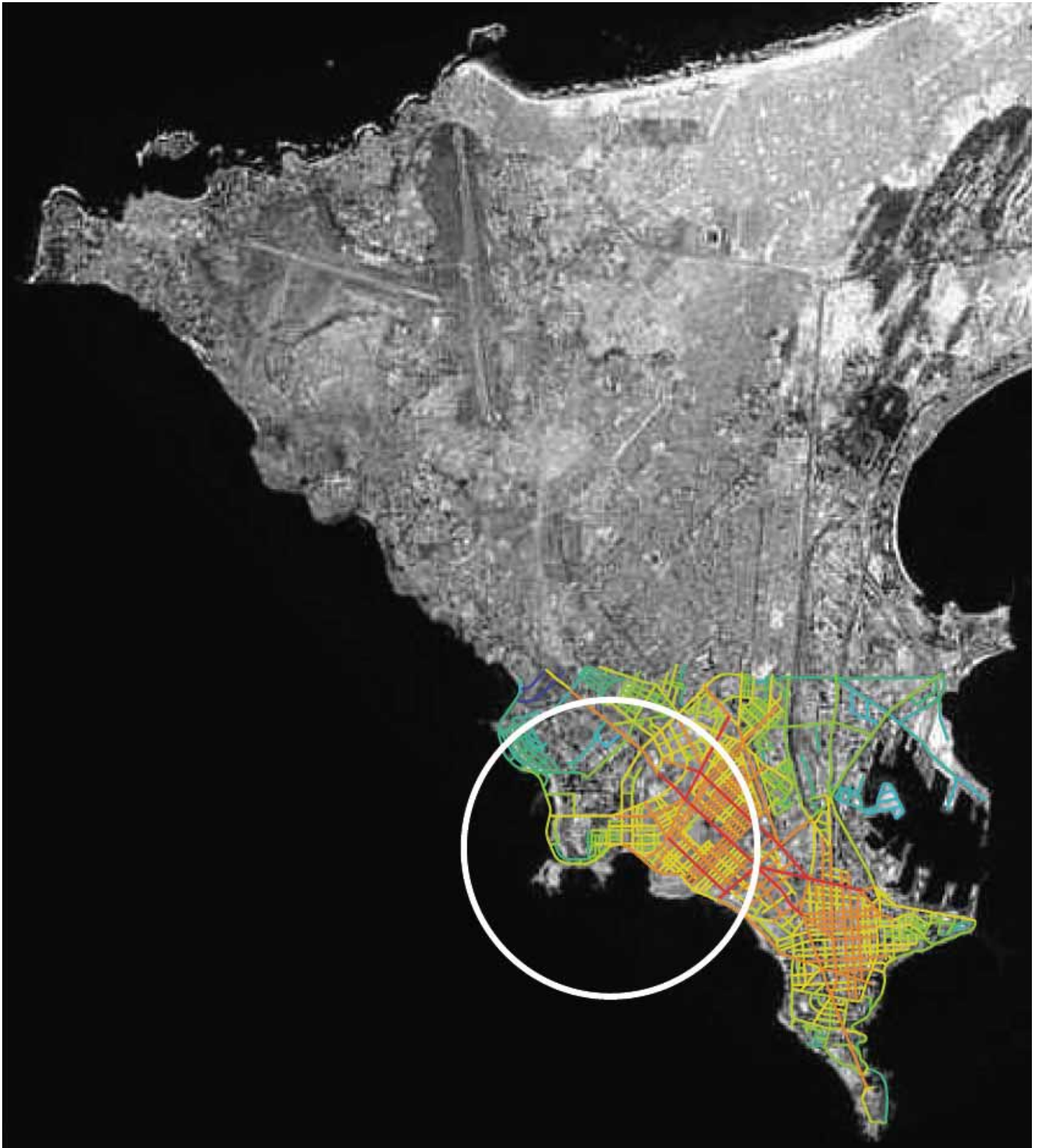

Dakar - Segment map of the city of Dakar (Integration)



Dakar 1942

The population of Dakar, today's capital of Senegal, was under 200'000 in 1942, distributed mainly near today's city center. Most of the Cap-Vert peninsula (red circle on country map) was uninhabited and mostly used for agriculture. The region then went through a period of exponential growth and today hosts almost 3.5 million people which corresponds to a population change of over 1500% since 1942. Its population now spreads the entire Cap-Vert peninsula. The main reasons of this rapid growth were the relocation of Senegal's administration from Saint Louis to Dakar and the foundation of the "Instituts des Hautes Etudes" which was developed into the large Dakar university (Université Cheikh Anta Diop de Dakar).

Such a population explosion was not easy to handle for Dakar's elite and until today many areas of the city lack of street infrastructure or covered sewage water channels. The railway system built by the French colonial authorities before Senegal's independence in 1960 had to be shut down recently due to unavailable investment possibilities.

Three of today's many major problems of Dakar - the open sewage water channels, the relocation of marketplaces away from the overcrowded city center and the segregated nature of some districts (we focus on Fann Hock) - are examined in this project.



Dakar 2011



Senegal - Cap-Vert peninsula (red circle)

The channel

Fann Hock is a younger, middle class district in the southeast of Dakar. It borders on the Atlantic ocean in the South, on the large campus of the Cheickh Anta Diop University in the West and the North and on another middle class district, Gueule Tapée, in the East. Since Gueule Tapée is the only neighboring district of Fann Hock with shopping facilities and business possibilities, its accessibility is immensely important for the residents of Fann Hock. Unfortunately, for the residents of Fann Hock, this accessibility is severely limited through the open sewage water channel which is only traversable via two small footbridges for pedestrians and not at all for vehicles.

The coverage of the open sewage channel is an ongoing project of the city but the construction works have currently stopped due to poor comportment of the residence population according to the mayor of Dakar, Khalifa Sall (Le Quotidien 2013). Particularly the stealing of manhole covers and many more construction materials would make a completion impossible, so Sall.

We believe, that such misbehaviour of some individuals would be better controlled by the residents if they knew all their benefits of a coverage of the channel. Derived from this idea the goal of our research is to demonstrate the benefits of a possible channel coverage, which then hopefully allows a resumption of construction work.

To do so we explore the spaces around the channel using the space syntax methods of integration (measures topological centrality) and choice (movement flow potential) on three basic conceptions of space. First we created a segment map of the street network in the Dakar centre area to examine the greater Fann Hock neighborhood, second we generated an axial line map to forecast the impact on Fann Hock through a canal coverage and third we provided an isovist map to test the capability of the possible new area above the channel as being used as a new marked place.



Channel - Fann Hock



Channel - Fann Hock



From left to right: University of Dakar, Fann Hock, Gueule Tapée and Médina



Connection between Fann Hock und Gueule Tapée interrupted by the channel

Relocation of marketplaces

As mentioned before, the population expansion of the Dakar area causes major problems. Especially the city centre area is overcrowded most of the time.

In order to ease the fight for sales places in the city centre, the city's administration around Khalifa Sall banned the simple traditional wooden market stands, which are often located in front of magazines, in some highly crowded streets in the city centre. A new location, near the port, was allocated for the traditional vendors.

To examine the quality of this new market location, we calculated the choice and integration of the street network for the Dakar centre area (on the right). The results clearly show low choice and integration values (blue to green) for the new market area near the port. Many vendors already left this area and work now as flying vendors back in the city centre where more potential customers are around. This is approved with high values for integration and choice (orange to red) which are crucial for a market place because a high centrality and a high flow potential are fundamental for good selling results.

Our advice is to relocate the traditional market stands on the covered canal between Fann Hock and Gueule Tapée because the values of integration and choice values are better than near the port and would grow with some new streets crossing the channel. In addition to the better selling prospects of the traditional vendors the channel problem would be solved and the separated resident district of Fann Hock would be better integrated.



Crowded city center



Port area of Dakar



Traditional market stands



Segment map (Integration), from left to right: Fann Hock, Dakar city, port



Segment map (Choice)



Axial line map (Integration) of the districts Fann Hock, on the left side of the channel and Gueule Tapée, on the right side of the channel (red for high and blue for low values)

The map shows a relatively low integration for Fann Hock and most areas with high integration value are located in Gueule Tapée where the major school and the major market of the two districts are.



Axial line map (Integration) without the channel

If the channel was removed the overall integration of Fann Hock would raise considerably and the areas with the highest centrality furthermore cross the potential market place above the channel and predict therefore many customers and tourists for the vendors.



Axial line map (Choice) red for high and blue for low values

The map nicely shows the relatively low movement flow potential of most areas in the two districts. The possibility to cross the channel with the highest choice value is near the highway which contains danger especially for kids on their way to school.



Axial line map (Choice) without the channel

If the channel was removed an area with a high flow potential would reach Fann Hock. The two channel crossing possibilities with the highest values would not be located near the highway and therefore contribute to a safer and qualitatively higher standard of living. It although means many potential customers.



Isovist field map (Integration) red for high and blue for low values)

The map show a relatively low visual integration of Fann Hock in comparison with Gueule Tapée and no location in the area has the potential to be transformed into a lively marketplace.



Isovist field map without the channel

If the channel was covered and some of the trees besides the channel were removed the visual integration of the new location would have the overall highest value of both districts which would be ideal for vendors especially for the ones looking for tourists.

The market space in Dakar is informal and so it's only possible to give the market borders, rather than formally plan it.

The Intervention should be understood as a pure zoning law of the new created space. There are just two zones, the market zone and a pedestrian non marked zone.



Marketplace in Dakar on the covered channel?

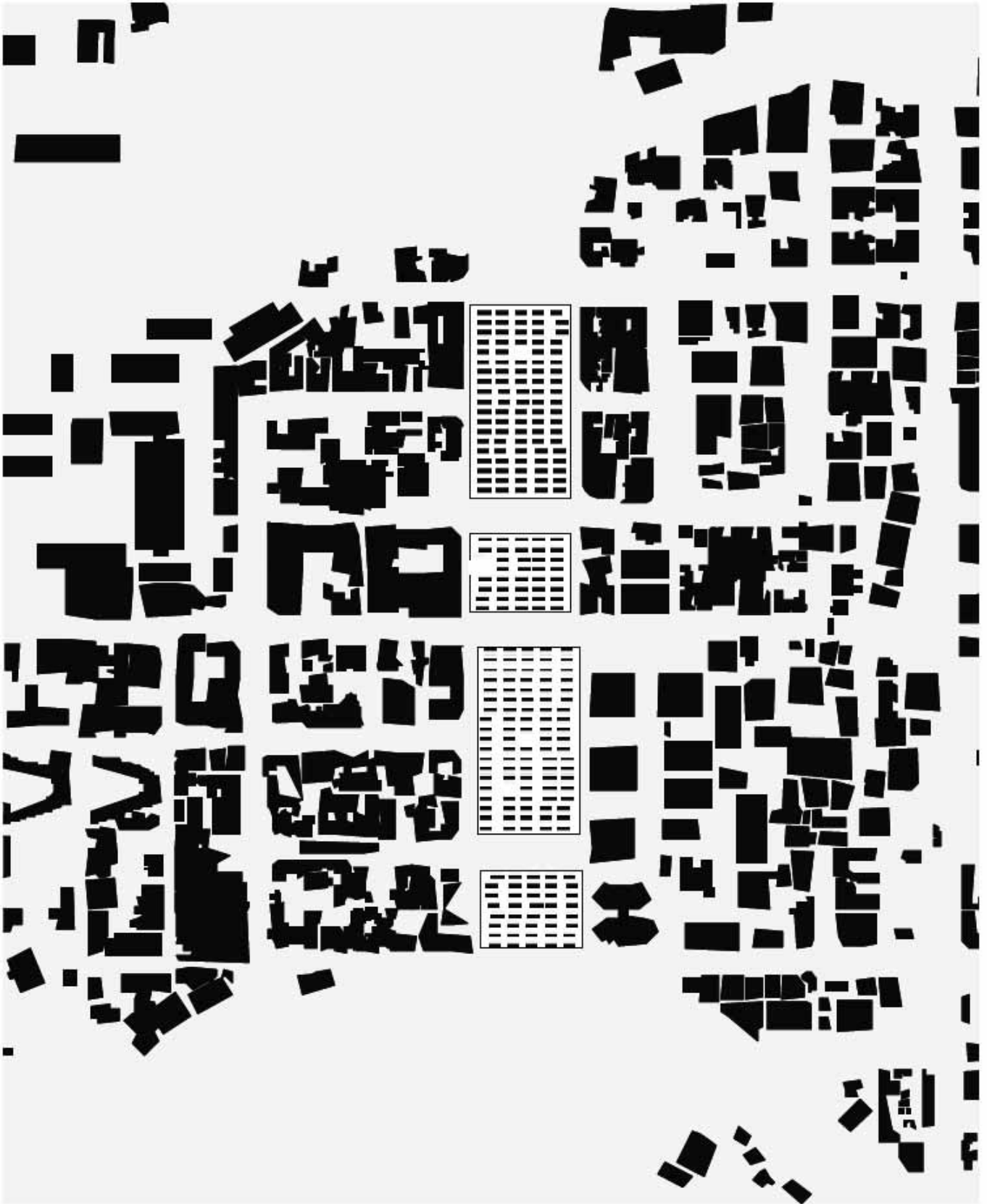

New marketplace in Fann Hock?

The Airport Backyard

Students: Lino Moser, Felix Ledergerber

Summary

This project looks at the street network of the Amsterdam metropolitan region in the Netherlands. The focus is on the areas separated from the city of Amsterdam by Schiphol airport, which lies in the municipality of Haarlemmermeer between Amsterdam and Haarlem. As the fourth-largest airport in Europe (by total passengers), Schiphol is a node in a global network. However, it also impacts the topography of its immediate surroundings.

What happens in between a major city and its airport has been addressed in other research projects. We are interested in what in our design studio has been called the «Airport Backyard». These peripheral areas are usually considered individually, but as they share many characteristic traits as well as challenges, this project considers them one large urbanising agglomeration within the Amsterdam metropolitan area.

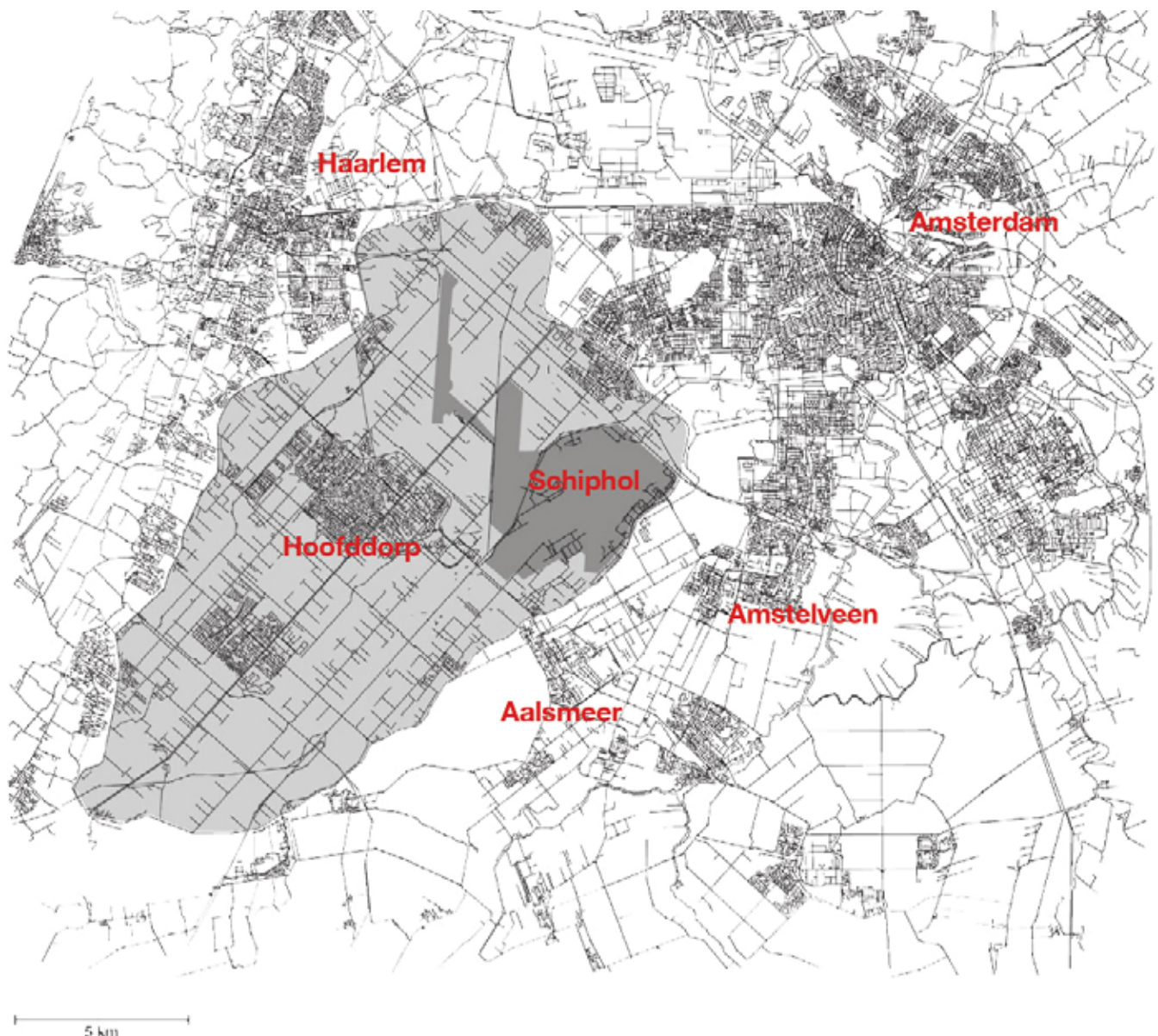

We analyse the street network using the space syntax method, in order to gain a better understanding of some of the connections within the region. Integration analysis is used to evaluate the existing connections and to look for missing links, while choice analysis is used to locate potential for future development.

Motivation

Within our fifteen-person design studio, we worked on understanding the different infrastructures crossing and affecting the Amsterdam-Haarlemmermeer-Schiphol area. In trying to understand the region as a landscape of flows, we struggled with a lack of quantitative data, especially when it came to people flows. Using the space syntax method gives us a qualitative understanding of the street network of the area.

In a first step, integration analysis is used to gain a better understanding of the region. Perhaps it can help explain (along with other, airport-related conditions) why certain points in the network have their specific characteristics.

The second potential step is to use the space syntax analysis to figure out where to best channel the considerable projected population growth of the region (Haarlemmermeer +40% by 2025, source:CBS). Finally, we hope to gain some insight as to which steps could be taken to better integrate the area on a regional scale, since there already is a lot of long-distance commuting and the projected population growth should not be met with a proportional growth in daily kilometers traveled.

Axial Line Map

We use this axial line map of the Amsterdam metropolitan area, kindly provided by Professor Akkelies van Nes at TU Delft, for all of our space syntax analysis. Considering the areas around Haarlem, Hoofddorp and Aalsmeer as an outer ring of the metropolitan area raises some challenges related to the relative dominance of the city of Amsterdam, in terms of sheer size as well as in terms of being the focus of much of the street network.

The dark grey shape labeled Schiphol shows the territory of the airport, while the underlying light grey area represents the municipality of Haarlemmermeer, which is home to Schiphol airport. The political border of this municipality follows the Ringvaart, the canal which forms the physical edge of the Haarlemmermeer polder (land created in the place of a lake using windmills, pumps, and a network of canals in the 19th century).

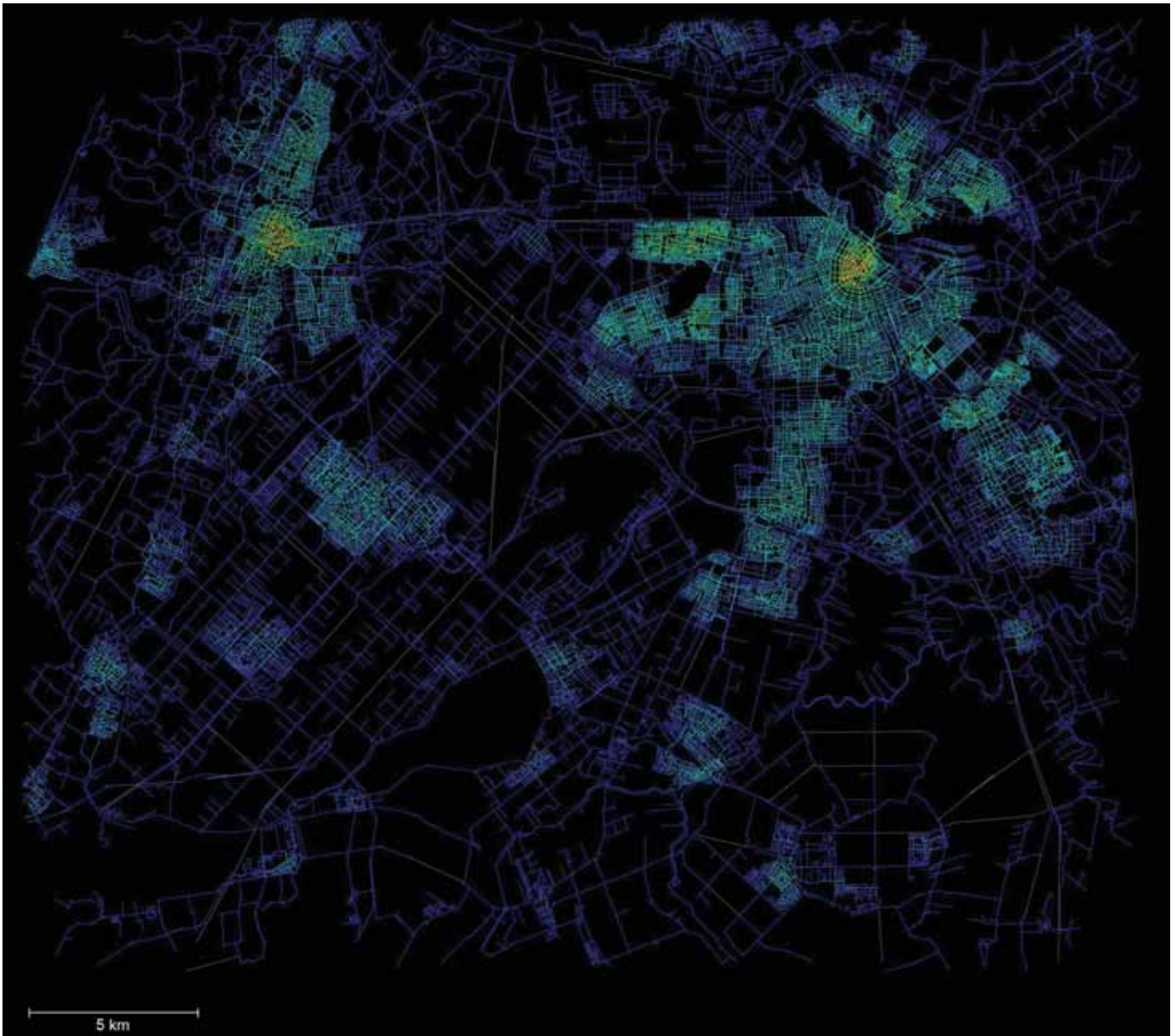

Integration – Radius 750 Meters

Using a radius of 750 meters simulates a pedestrian perspective on the integration of the street network. It comes as no surprise that the historic centers of the two old cities of Amsterdam and Haarlem perform very well in this analysis. This result correlates with the subjective experience of the pedestrian friendly character of historic centers in European cities in general and in this region specifically.

Somewhat astonishing, however, is how well integrated the Slottermeer area west of central Amsterdam is. The Nieuw-West residential expansion of Amsterdam was built after the second World War, in an era of car-oriented modernist planning, which is not known for creating pedestrian-friendly neighborhoods. Perhaps this quality of the street network is one of the reasons for the recent growth and development of this area around the Sloterdijk train and metro station as a multifunctional business district.

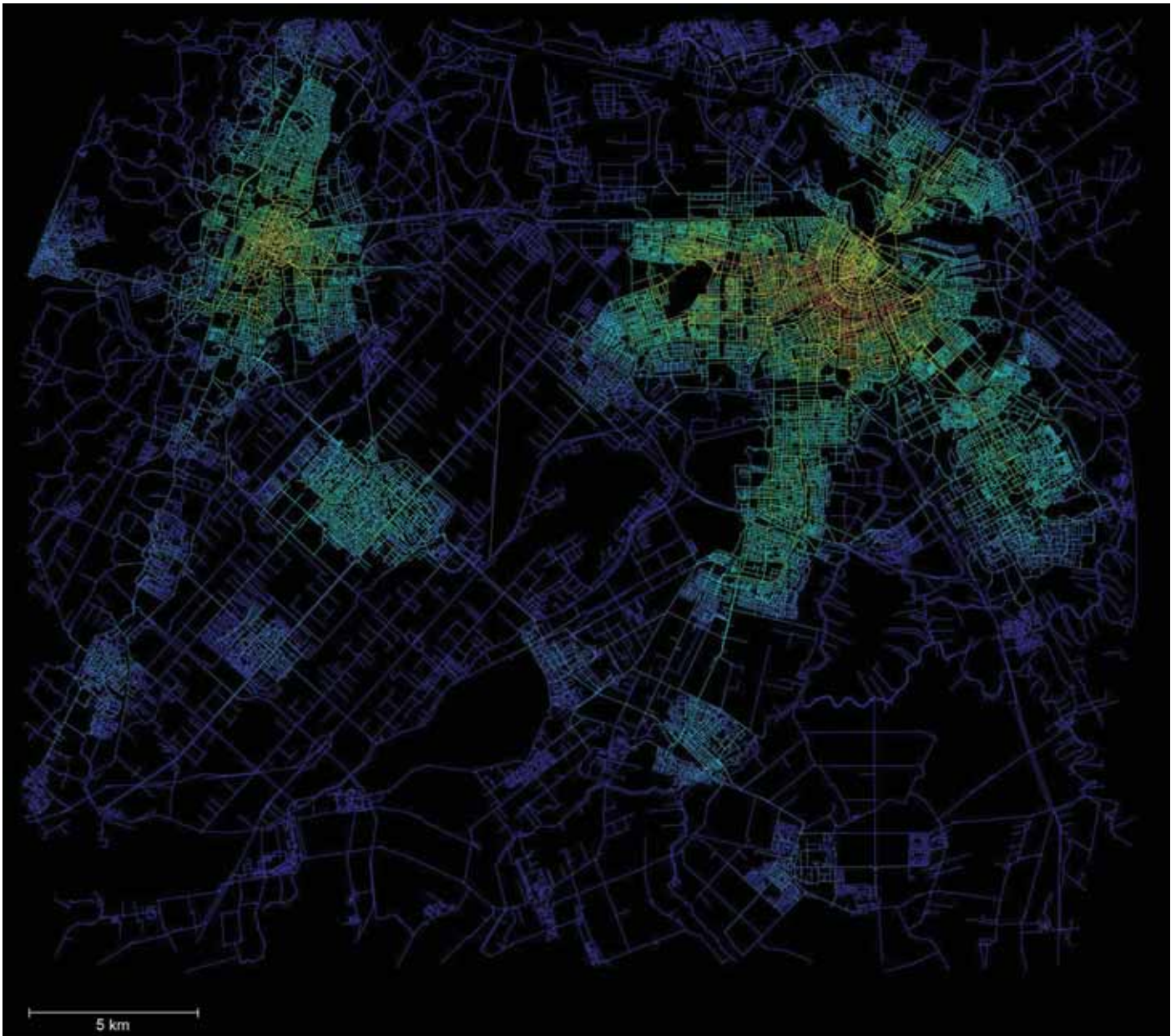

Integration – Radius 3'000 Meters

A radius of 3'000 meters represents a bicycle-centric integration analysis, a topic of obvious interest in the general sustainability debate but also in the specific context of the famously bicycle-friendly Netherlands. Again, the core areas of the two historic cities perform very well.

The Stadhouderskade just south of the famous 17th-century Grachtengordel canal district shows up dark red, confirming the reputation of the 19th-century southern expansion Amsterdam-Zuid as extremely comfortable to experience by bike. This area was the first major expansion of Amsterdam in an era when ships were no longer the only relevant mode of transport, and it has become one of the city's most popular districts because of its diverse neighborhoods and their great connections to the center of Amsterdam.



Integration – Radius 15'000 Meters

The region as a whole, however, is best understood on a larger scale. A 15 kilometer radius approximates the condition of driving in this street network, which is appropriate especially for the notoriously auto-centric municipality of Haarlemmermeer.

Parts of the expressway ring to the south and west of Amsterdam are extremely well integrated in this analysis, which makes sense because that is where the expressways have their highest density of on-and off-ramps. Some of the large central roads in the expansions of the last 150 years also perform well, while the historic core of Amsterdam is no longer so well integrated into the street network when it is analyzed from the point of view of the automobile.

Surprisingly, however, the street layout of the Haarlemmermeer is poorly integrated across the board. This seems to contradict the area's reputation as having some of the highest rates of traveling by car in the country. Of course, there are other factors that come into play here besides the layout of the street network as the one-sided modal split has a lot to do with the choice of public transportation options (or

lack thereof) available in the Haarlemmermeer. On the other hand, the way the map is drawn, including the entire city of Amsterdam with its dense street network, means that wider spread grids, especially at the edges of the map, will always be relatively less integrated.

But there is also a lot of truth in the picture this analysis shows. The original layout of the Haarlemmermeer polder is very widely spaced (approximately 2 x 3 km grid), since it was planned for agricultural use and therefore needed large continuous plots of farmland. Each successive new infrastructure that has been placed in the Haarlemmermeer (airport, expressways, etc.) over the last 50 years has further dissected these already sparse connections.

The result of all of this is that the Hoofdvaart, the central axis of the polder spanning its entire length from southwest to northeast, is the best-integrated part of the Haarlemmermeer network, especially where it connects to western Amsterdam. In reality, though, the Hoofdvaart is just a narrow, tree-lined road along a canal, just like all the rest of the original street network of the polder. It is poorly suited to being a major connecting segment in the regional transport system and cannot have the importance suggested by this analysis.



Schipholweg

The Schipholweg stands out as being surprisingly well integrated in the 15 kilometer analysis. We also observed some interesting patterns of use along this road, which does not at first glance appear to be such a high quality location. The Schipholweg is a country road connecting Amsterdam and Haarlem, but it runs just north of the airport runways and is some of the most noise-polluted land in the region.



Land Use and Integration Values

Land use data for the region (from www.geofabrik.de) seems to confirm the first impression: the whole area is farmland, except for grassland surrounding airport runways and expressway interchanges, with only one isolated residential strip along Schipholweg.

However, data our studio group collected on site shows a very different picture. The diversity of commercial and industrial uses of the buildings in this strip rivals some much denser urban areas, and very few houses are actually used residentially.

Some of this is explained by the location (lots of noise, cheap land, lax government regulation), but the high integration of the Schipholweg due to its proximity to the cities of Haarlem and Amsterdam as well as its easy expressway access surely also plays a role. These are essential qualities for businesses that rely on delivering products as well as those which want to grant visiting customers a high degree of anonymity.

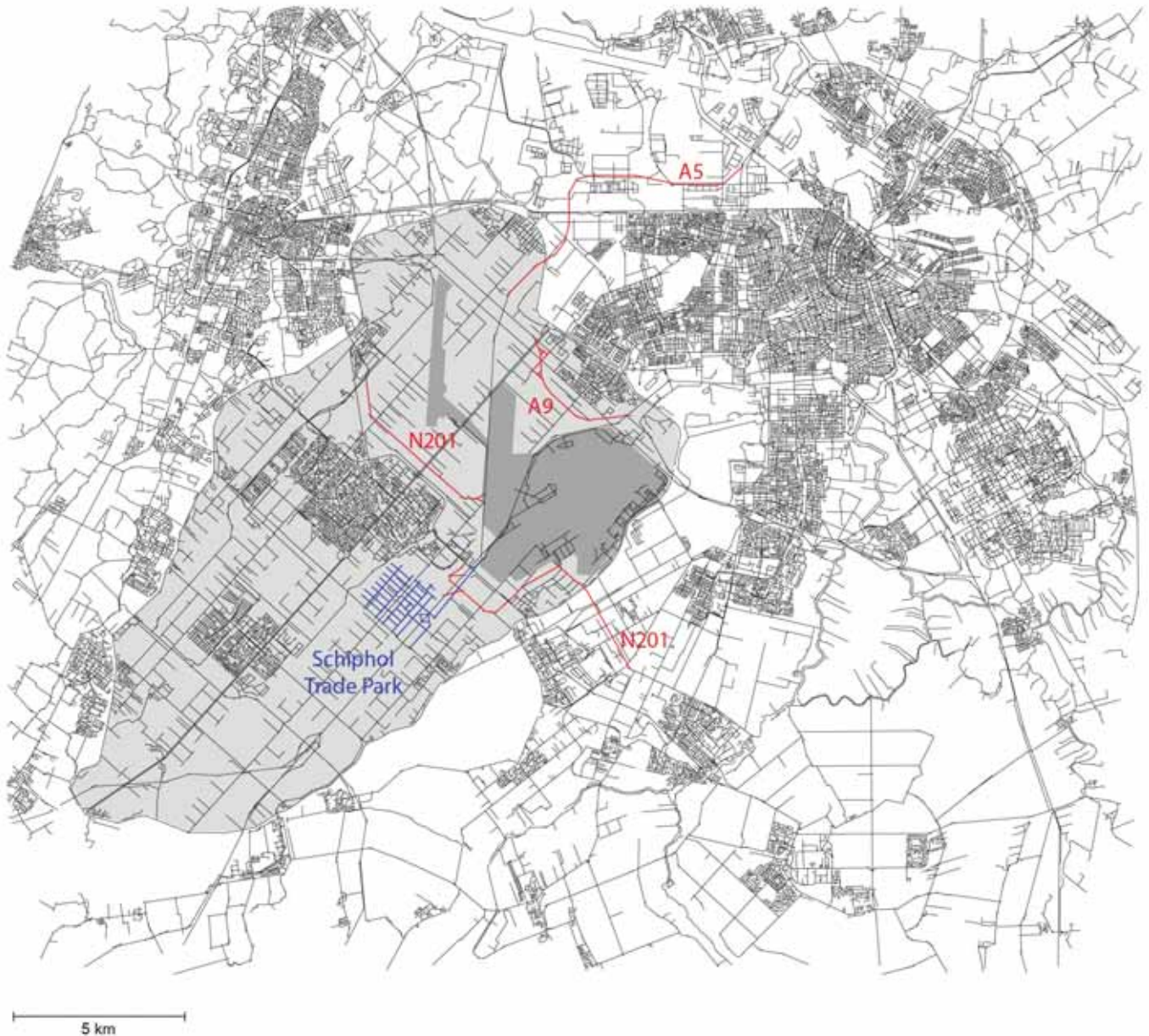

Additions to the Street Network

There are several high-profile additions to the existing street network in planning or under construction at the moment. These are infrastructure projects on a national scale, meaning that expressway- and national road construction is designed to serve a larger region than the one we are focusing on. We nevertheless want to add them to our map to test what impact, if any, they have on the integration values of the street network.

The addition of the Schiphol Trade Park (in blue) is a local development plan for logistics enterprises, to be built in Hoofddorp but focused on the airport. This will be discussed in more detail on the next page.



Integration – Radius 15'000 Meters

Running the analysis for the integration of the network with a 15 kilometer radius again reveals that most of these complex and expensive infrastructure projects do not have a profound effect on the network as a whole.

Only the new path of the A9 just north of the airport has a significantly higher integration value than the stretch it is replacing. The N201, being built to relieve Hoofddorp of the congestion due to through traffic, is actually more segregated than the old roads of the original polder grid.

It is clear that the existing government plans for the street network in this region do not make the region better integrated, more interconnected, or balance the dominance of Amsterdam. Instead, these projects within a national-scale logic only solidify the status quo.

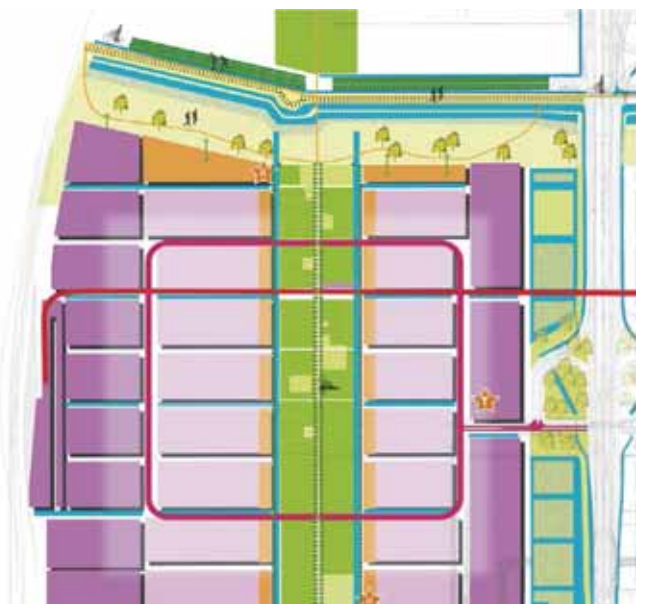
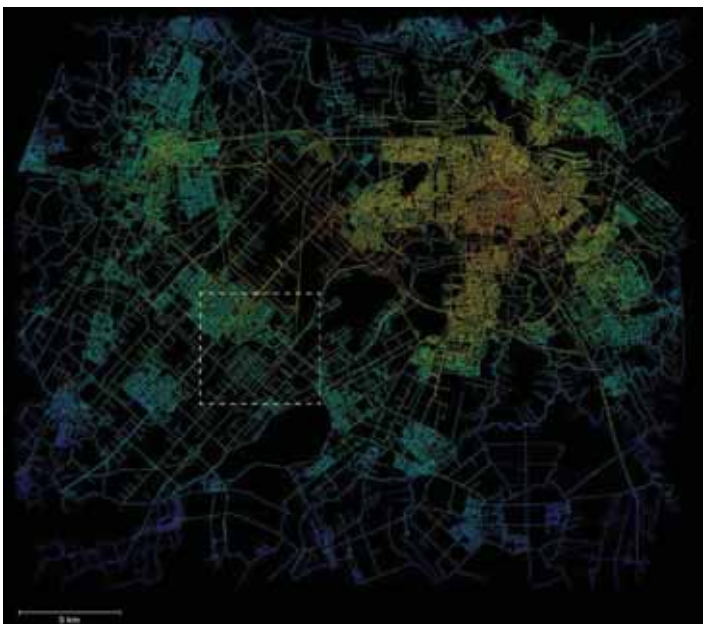
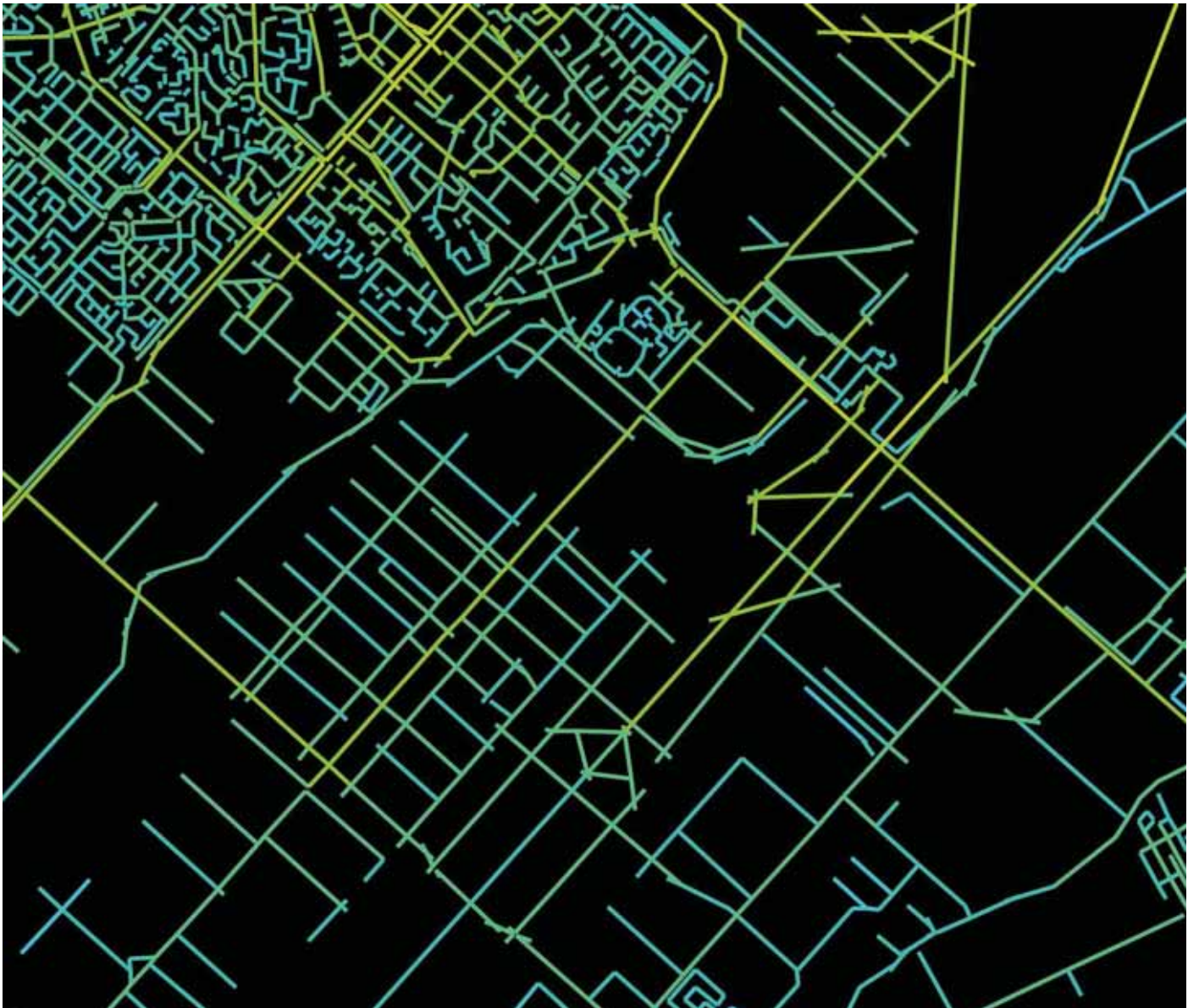

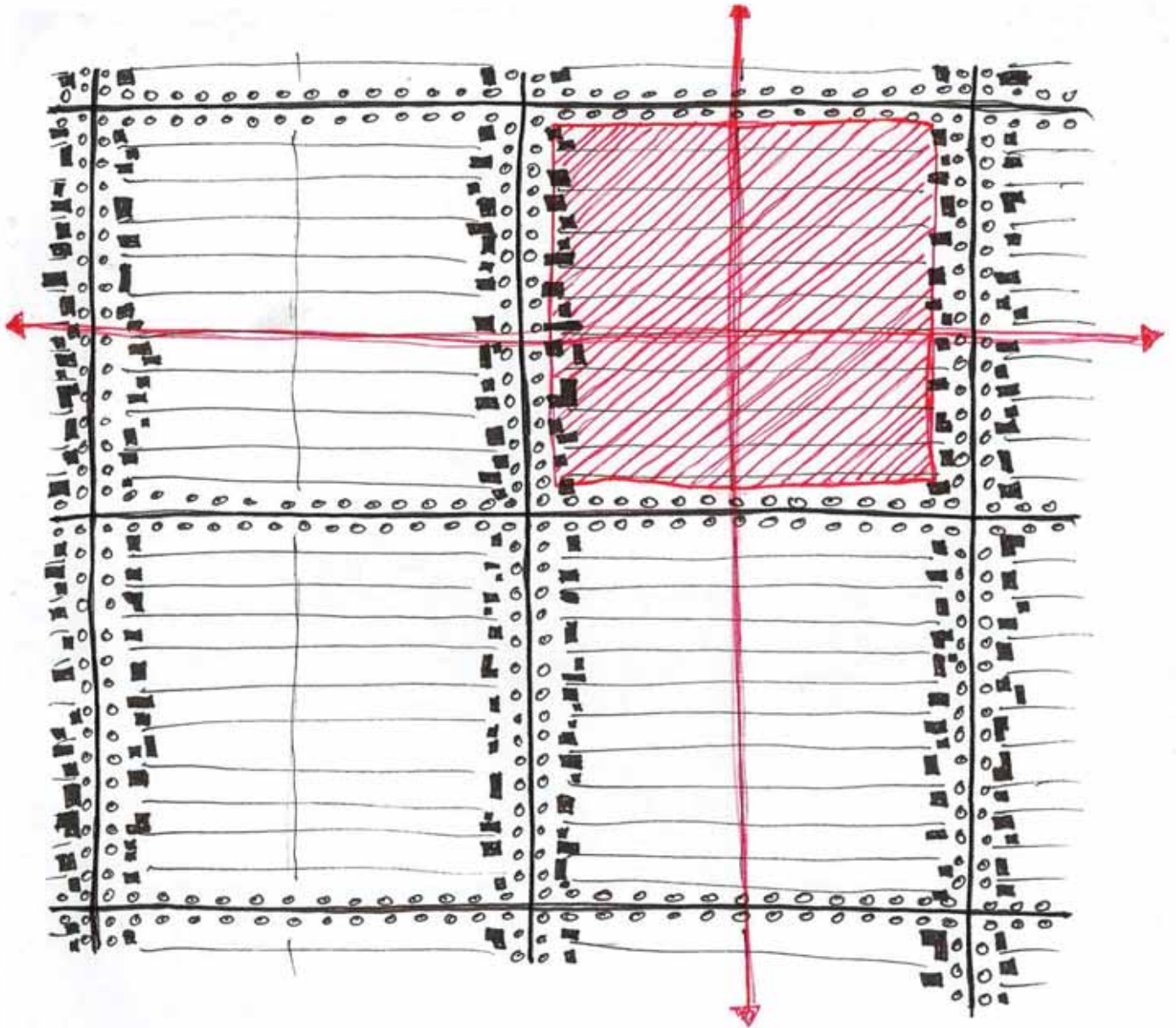

Schiphol Trade Park

This development project is an example of the monofunctional way of planning in the airport backyard. Out of proximity to the airport, developers have created a concept for a huge logistics park just south east of the Hoofddorp train station. The masterplan (left) follows the concept of the planners of the Haarlemmermeer municipality illustrated in the sketch above – new developments in the polder structure are supposed to provide new transport infrastructure, parallel to the existing street grid of the polder.

The integration analysis (15 km radius) shows that this particular development proposal in fact only accomplishes higher probable usage of the old polder roads, because its new street grid is so poorly connected to the rest of Hoofddorp.

In the logic of the developer this is not a problem, but long-term thinking would suggest that a different layout, better connected to the center of town very close by, would have a much better chance to take on different functions as the importance of logistics shifts or Hoofddorp becomes a more diverse city.





Conclusion

Analyzing the integration of the street network in the Amsterdam metropolitan area has helped us understand how this network functions, and where there is a need for better connections if we are to reach our goal of channeling growth into a denser, better integrated urban structure.

Looking at existing plans by the national government, the municipality and private developers with the space syntax method has given us scientific arguments against certain ways of planning and building in the region. Focusing on one issue, scale or use will not work in the long run. This is especially important since the street network generally has a much longer life span than the buildings built along it, so the mistakes made today will prove costlier and more long lived than those an architect or designer might make.

Without having a specific alternative proposal at this moment, analyzing the integration qualities of the region has lead us to specific points in the network where we see the potential to develop an alternative project strategy to strengthen the airport backyard as an equal part of the metropolitan region instead of cementing its status as its backyard.

Outlook (Choice – 15'000 Meters)

The choice analysis, also with a radius of 15 kilometers, has so far not been very consequential for our work. However, as the project unfolds in our design studio and the individual groups broaden their focus beyond the specific topics, this analysis starts to make more sense and becomes very useful.

Besides some of Amsterdam's central arteries, the Kruisweg between Hoofddorp and Haarlem has the highest choice value in the region. This is both an argument for seeing these smaller cities as connected parts of a polycentric metropolis, as well as a reason to focus our design energy on this largely unbuilt, „in-between“-space. The high choice value is probably a result of the bottleneck effect due to a lack of alternative connections between the two cities, but it hints at a potential for a varied, multifunctional, user-intensive program that could be implemented in this area.

Riponne Maurice Béjart: An Urban Premise

Student: Doan T. D. Tom

Summary

The Place de la Riponne in the city of Lausanne is a controversial space. It is situated in the heart of the city, considered one of the main focal points, a symbol but yet, empty, lacking of functions and deserted. Inhabited temporarily and sparsely by walkers, Wednesday and Saturday markets and mainly by party people on week ends and other social problems. It is one of the spaces that receive the most complaints in terms of security in Lausanne.

Once a crowded and useful place, in 1925, aided by the presence of the "Grenette" building, acting as a storage and a market place, after the building's destruction, the place became an empty wide administrative space.



Motivation

Its situation is intriguing because, a short distance to the south, the most successful public spaces in Lausanne are situated, such as Place de la Palud, the Great Escape bar, la Rue centrale and the Place de l'Europe.

The project aims to understand the underlying phenomena that prevents Place de la Riponne to become functional public space. Rather than a complete project, it tries to envision the premisses of an urban or architectural project through analysis, which, then would support further argumentation of a project.

The analysis remains open to interpretations, hinting at decisions. The analysis will be made with analysis tools such as Depthmap analysis and Ecotect. Its interpretation will, if relevant, draw a parallel with theoretical works.



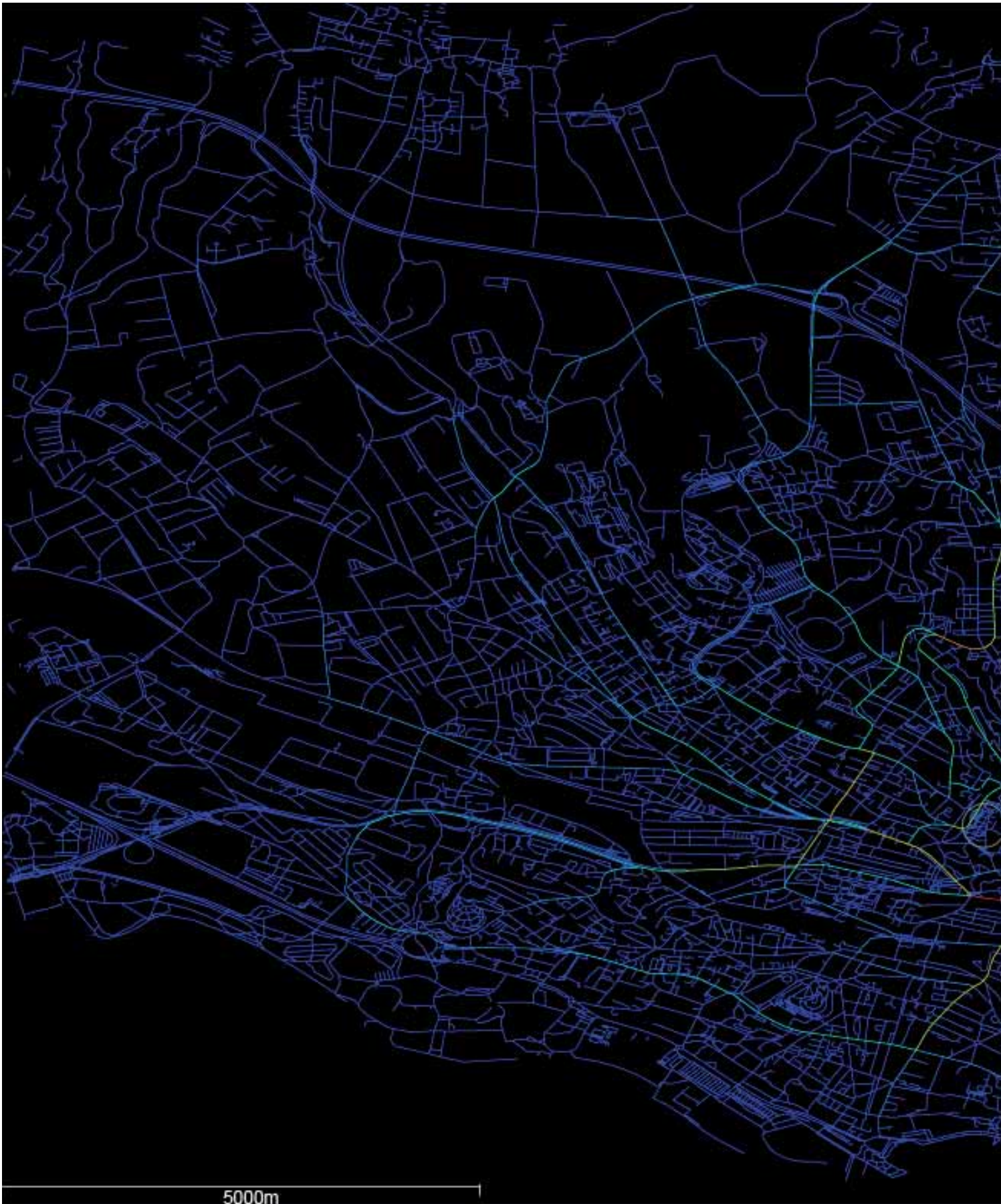

Street Network Choice Analysis: 1:10'000

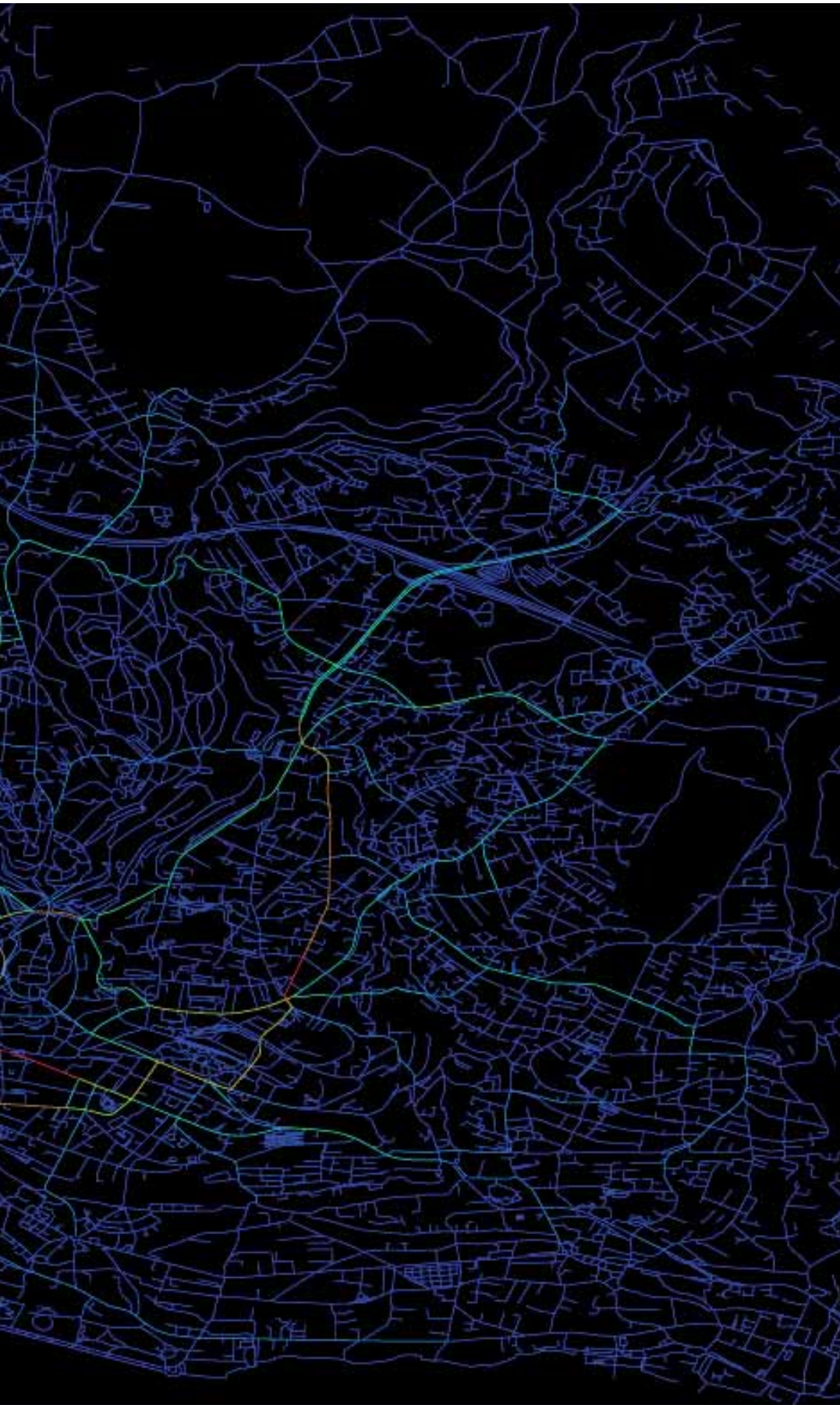

This analysis aims at regional automobile movement analysis to define whether or not the Riponne is surrounded by an important network on a regional scale.

Within this road network choice analysis: while in the north of the area is heavy in traffic and also the south (Place Saint François), Riponne is not a heavy axis of mobility (confirmed in the analysis and in real situation observation).

Hence, it has a potential of creating quiet and pedestrian public space while its regular car circulation defines that it is also serving numbers of people on the regional scale. There is a balance between quietness and accessibility.

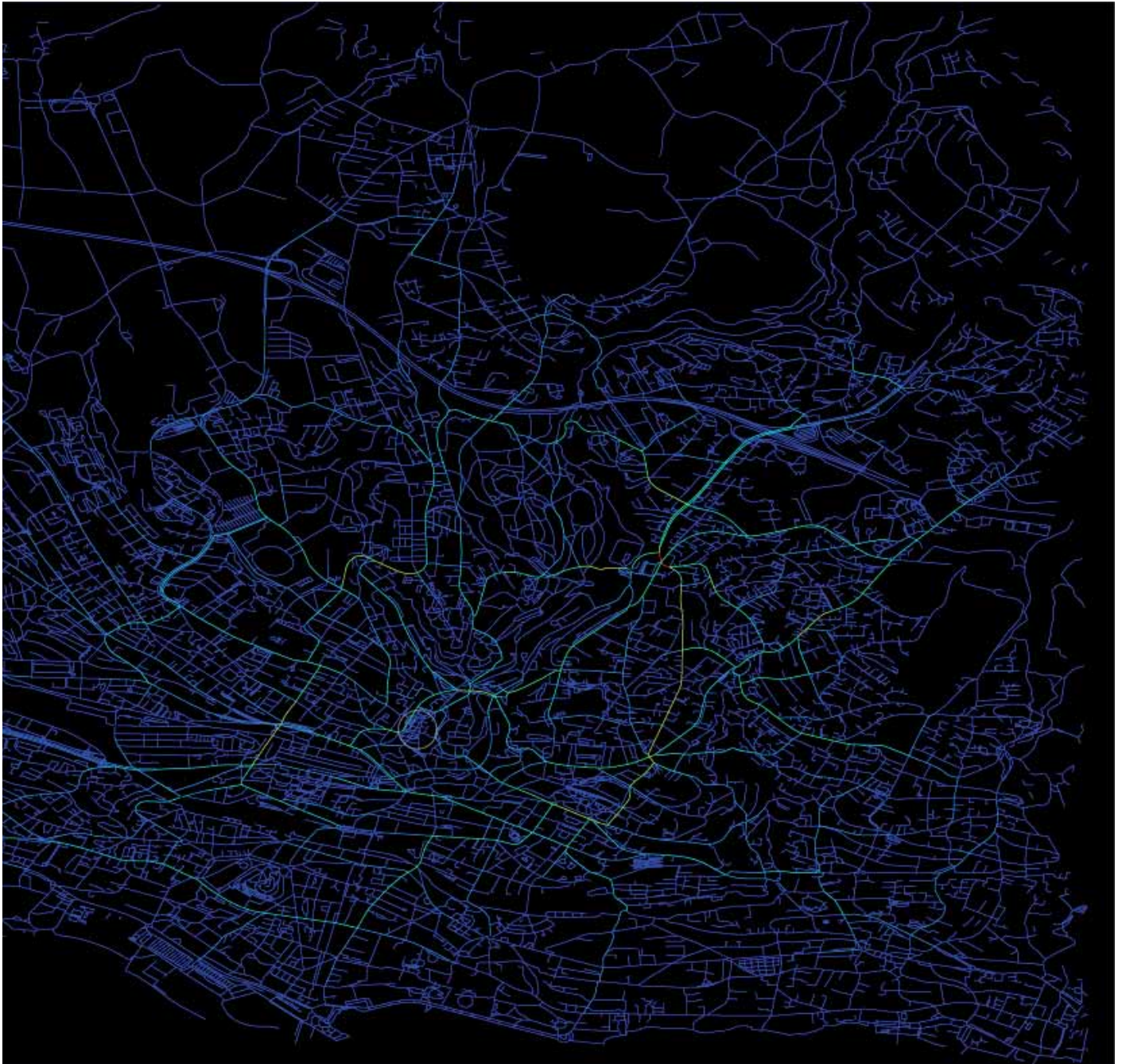

Street Network Choice Analysis. radius 5000m

Framing the analysis at 1:5000 allows an analysis of the local auto mobile scale, if, within the network of the city, people that inhabit in a 5km radius will go through the Riponne. Amongst the average of the city, while the choice value is quite low, it is one of the highest axis. This would mean that, given the choice, local people would pass through Riponne. This makes this place very sensitive to commercial activities or manifestations. It would also mean that, to the city, it has a potential quality higher than what exists today. The mean that the city "solve" this accessibility is to put a parking on its edge and a metro station. In this analysis, only its major axis is activated and its secondary networks have low choice value.



Street Network Depth Analysis. radius 500m

The depth analysis would define a number of subcenters in the area. This analysis gives a slightly inaccurate result. The Riponne and its surroundings are central, the same as the city old castle and the train station which corresponds highly to the reality. But certain northern parts of Lausanne, such as Beaulieu, are indicated to be very central but in reality, the area is a mono functional area with very little pedestrian traffic. The same is for Chailly, while the analysis points straight to the center of the neighbourhood, the reality is that it is a villa mono function area with little urban activity. Never the less, solely based on geometries, this analysis points the the potentials of theses centers: given the right accessibility and the right functions, it could eventually become a lively place. Not only this places Riponne as a "go by" area but gives it a potential to become a subcenter.



Shadow Range 21st June

The shadow range analysis give a intrinsic quality of Riponne. It aims at the sun at its highest point, 21st of june and at its lowest point, 21st of december. In an usability of an urban space, shadow is as important as light. When the ressource is scarce, it becomes a quality. When it is too hot in the summer, the shade is essential while the winter times benefit from the sun light. The strategic location of a proposal would be where these two conditions can be met during the entire year, making the space active at all times. By superposing the two analysis, these zones of polyvalence can be framed.

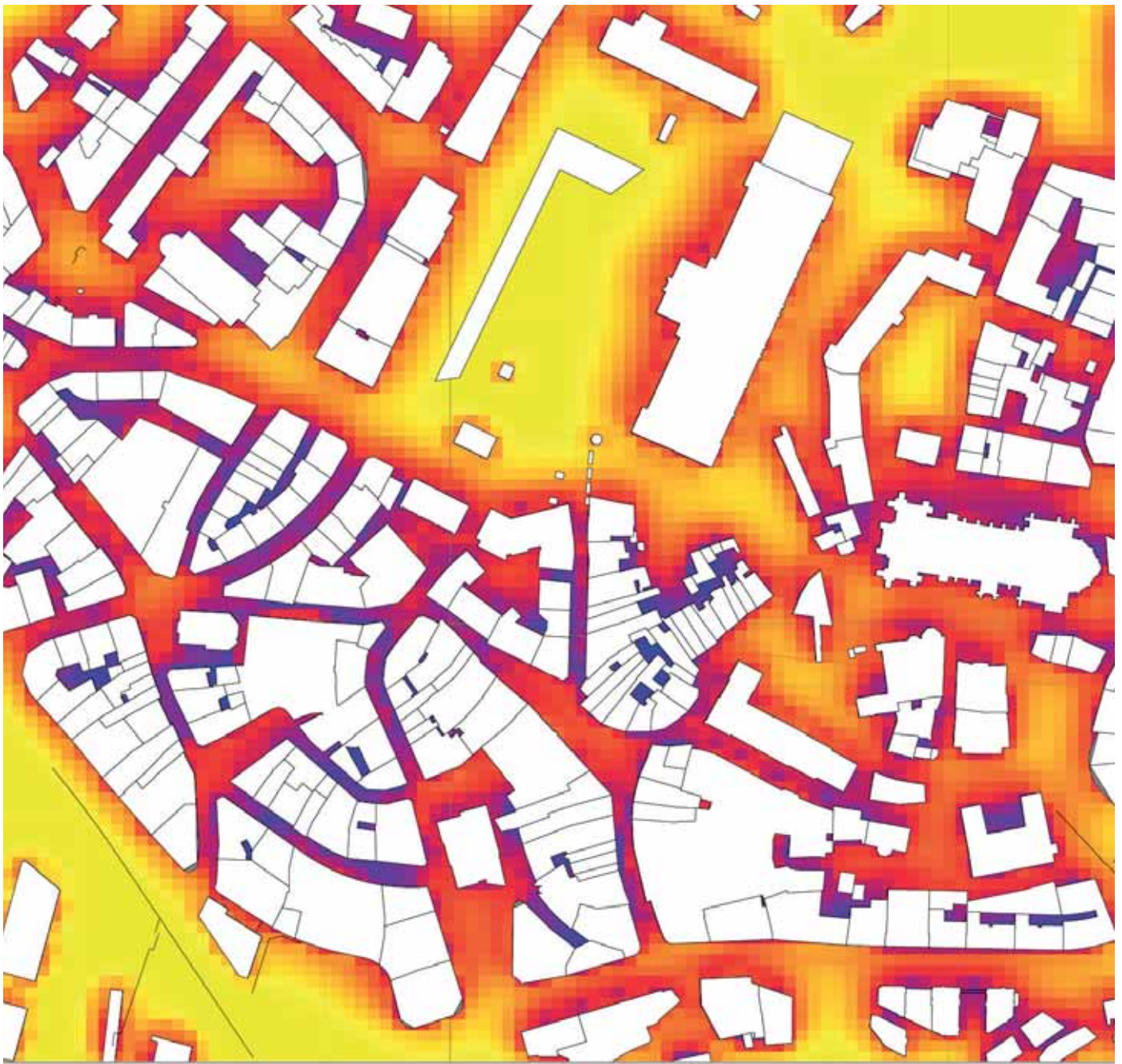

Yearly solar access

The analysis hints at a great potential of solar radiation at Riponne. It is an asset that can be harnessed. But, like discussed in the shadow analysis, too much of sun light would be a nuisance. The most popular space down south, Place de la Palud, has enough sun access, but is also bordered by spaces of shade. This punctuation and equilibrium is important to a quality space. Further more, the "adequacy" of enjoying sun light or shade in an urban space requires a small scale. While in abundance of sun light, it would be very strange to be sun bathing in the middle of a huge public space. The potential is there but smaller scale and adequacy should be emphasized.

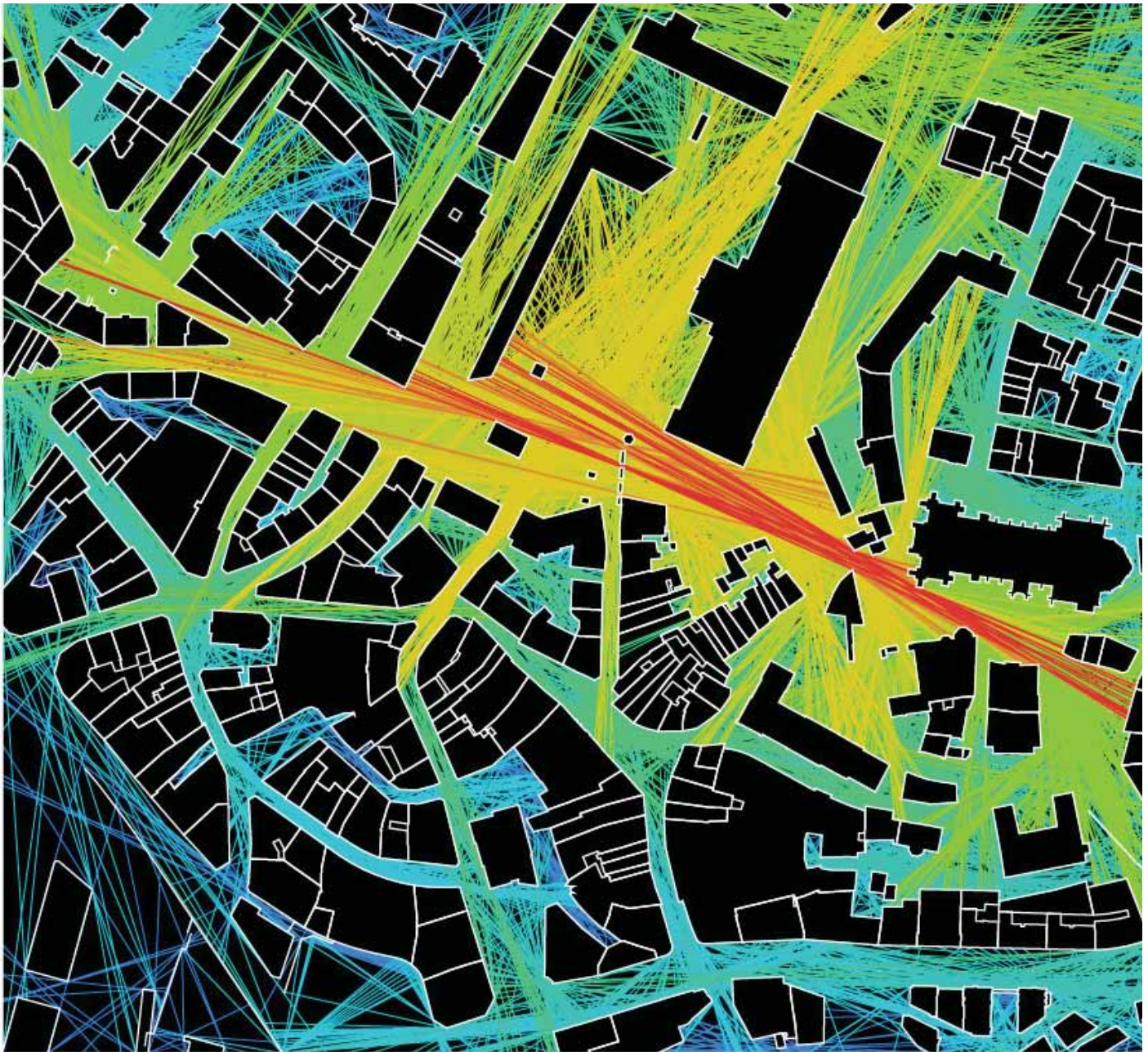

500m

Axial map Integration/Choice

The integration analysis indicates a contradiction: while Riponne is, in an observed situation, not so used, it hints at a huge potential integration. The main integration axis and choice axis already provide a real life result: at one end it is one of the busiest commercial street of the city and on the other end, it is one of the busiest bar. This hints at a potential of an intervention, profiting from this high integration and choice value. Further more, this axis aims directly at the cathedral, another not so popular space in Lausanne, reactivating this line by a proposal would give the city a bigger "loop" to reintegrate the cathedral site.

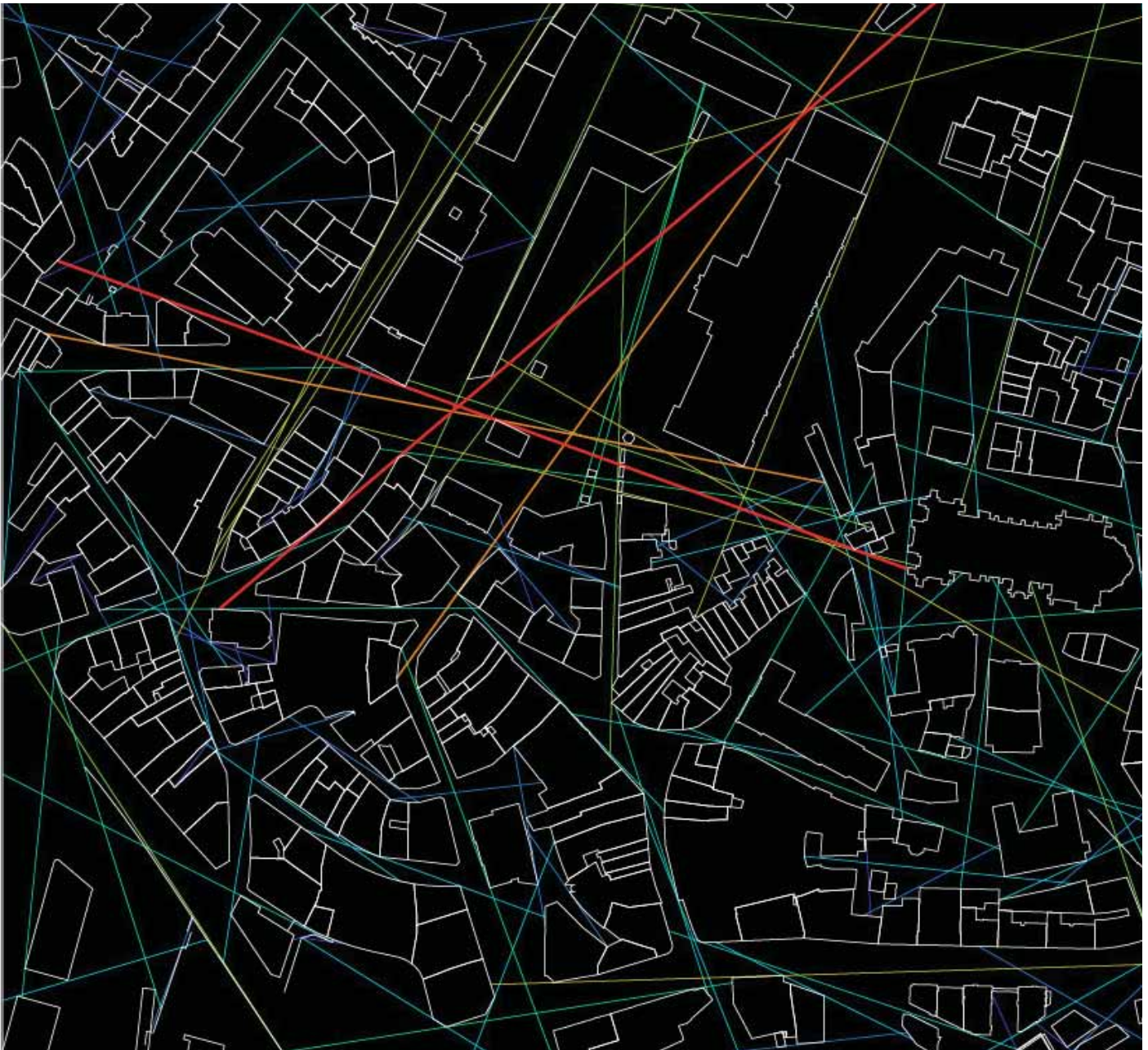

500m

Axial map Line length analysis

The line length analysis tackle the question of scale. It is very unusual, except when one has got a destination, to cross a great distance without doing nothing. According to the map, Riponne has 3 of the longest length of the area. These axis need to be broken down in scale in order for the space to be reactivated. Either programs can be spread across the space or it could form a loop, optimizing the integration and the distance break down.

This line length analysis can also be correlated with a density analysis. For an urban space to feel lively and crowded, it needs a certain number of people present at the same time. But, given the size of the Riponne, it would require an extraordinary (as in manifestations and events) of people to be present for it to feel lively. To give it a quality for every day activities, the scale and density need to be revised.

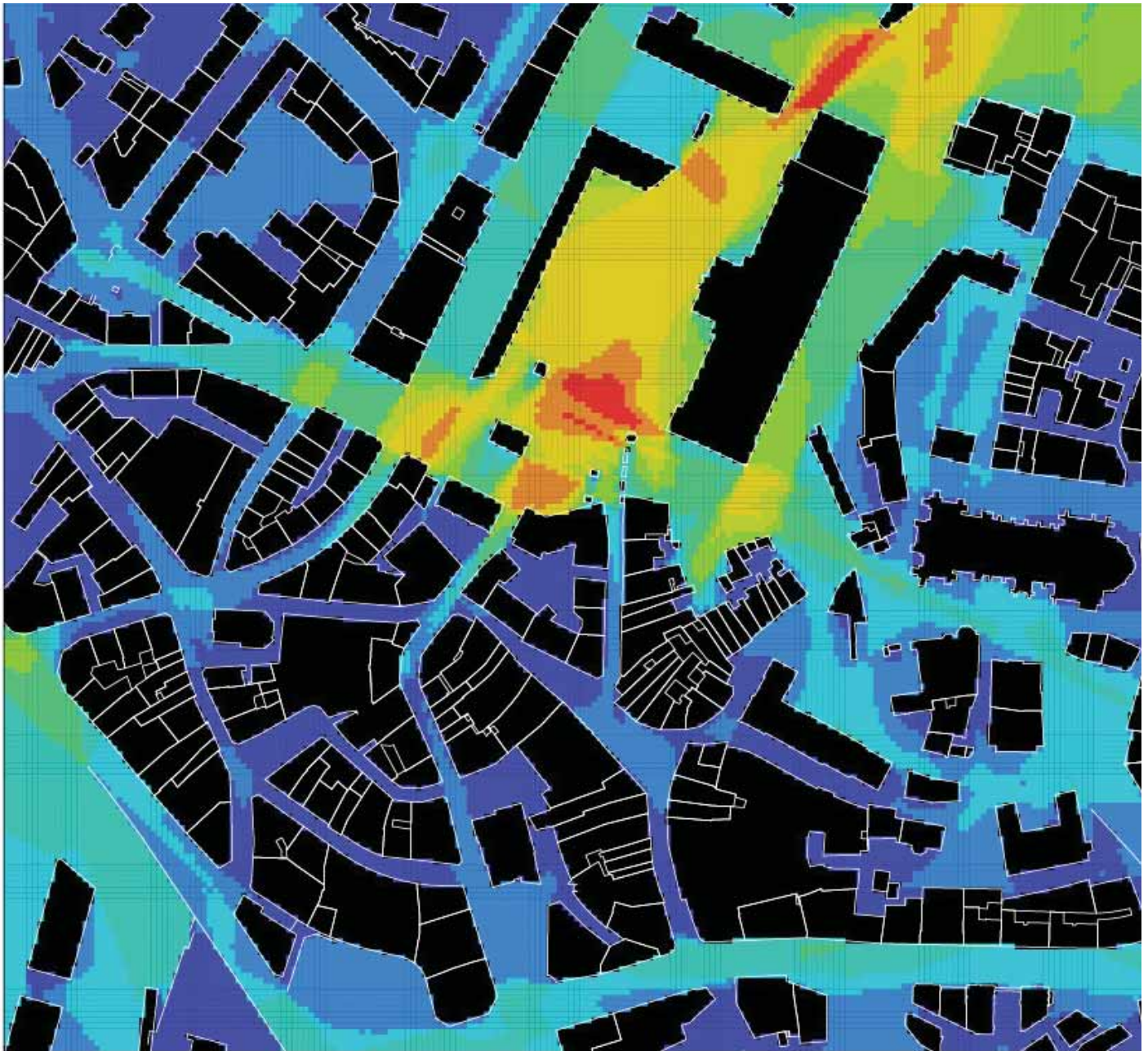

500m

Visibility map Connectivity

This analysis neglects the terrain. Never the less, given a sufficient height, a particular point of la Riponne is the most visible point of the area. Given this centrality, it could attract people and become a meeting point. This would enable Riponne in a slight larger scale (in the case of the analysis, 500m). Profiting from this visibility analysis, combining it with integration and choice, it hints at a quite precise area of intervention.

Conclusion

The street network analysis gives us a certain hints of the role of Riponne at different scales: non major regional car axis, high potential local car axis, central place in regards of pedestrian circulation and depth. It corresponds well to the scale within the city of Lausanne.

The sum of the analysis hints at a big potential for Riponne to become a very popular public space. Profiting from the overlapping of different proprieties of integration, connectivity, isovist integration, urban climate and choice, the project defines a precise area in which a proposal could be made to reactivate this central but presently empty public space.

Different issues are to be tackled if the project aims to integrate all these parameters and quality. The scale need to be broken down (according to the line length) in order to achieve a high enough density to form a crowd., the proposal need to be on the edge of light and shadows (as shown on the shadow range analysis). The functions attracting people would take place near the high integration and choice value, forming a function loop along with the rue centrale and the cathedral. Given a high enough quality and variety of function, it is a strategical point.

Interestingly, the visual connectivity doesn't correspond to the highest place of the space: the Palais de Rumine, but it is closer to the metro station. This would allow this area to become a visual signal, if taken in to account the varying landscape, with sufficient height, maybe in a typology of a tower, giving it a central identity.

Further advancement in the analysis would be to overlap the maps in different configurations and their combinations would give a more precise idea of where and what needs to be done.

Basel Mosque

Students: Dzenis Dzihic, Hugo Decramer

"A mosque where the praying hall is encapsulated within a volume of various functions. Multiple possibilities and paths give the users the liberty of directing their own route to the praying."

The project aim is to design a mosque for the city of Basel. Four different sites were provided and they were then chosen in relation to the predeveloped manifestos and concepts. In our case the concept was much about accessibility and storytelling. Therefore Volaplatz was chosen. A busy site facing an intersection where multiple paths meet each other. The area of the site is very diversified when it comes to typologies and functions.

Mosques, throughout space and time, often have urban and social qualities. In other words they have other functions than just the pure religious ones. Since Islam has been a controversial topic in Switzerland in recent years we want the mosque to have an informative role. The additional program for our mosque consists of an exhibition hall, a library, a language school, a café and an assembly hall.



Visual integration and connectivity of the neighbourhood

With this analysis, we wanted to compare our experience from the site with more objective data. As a next step we wanted to see what impact our new building would have on the visual integration and the connectivity of the neighbourhood. The crossing of Voltaplatz is, not very surprisingly, a spot with very high visual integration and connectivity. In reality, this place is a really busy intersection with most of the traffic passing through in the east-west axis. With the new mosque, we can conclude that the centerpoint of the crossing will be even more concentrated, both in its visual integration and in its connectivity.

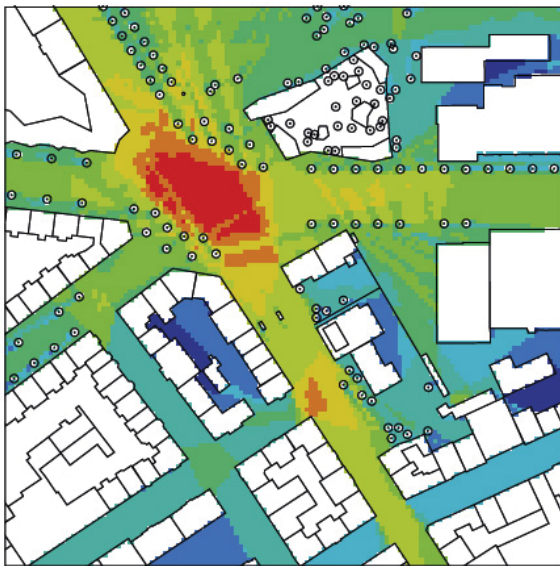

Visual integration (current situation)

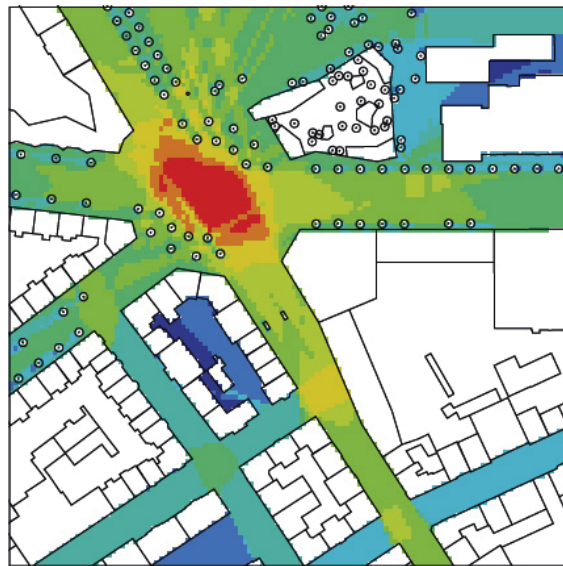

Visual integration (project)

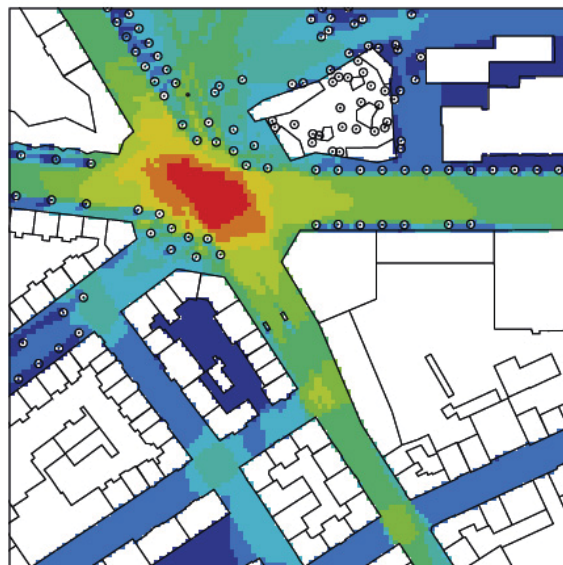
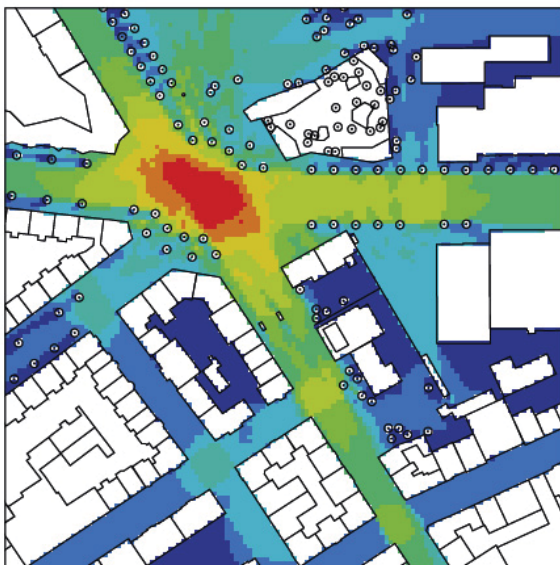

Connectivity (project)

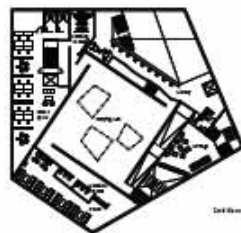
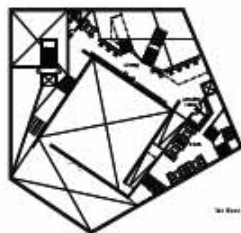
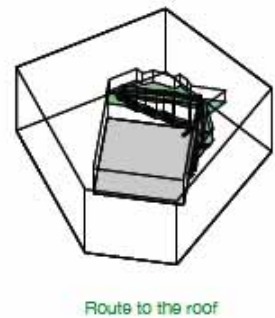
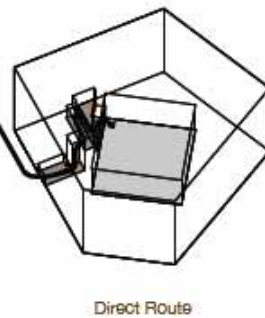
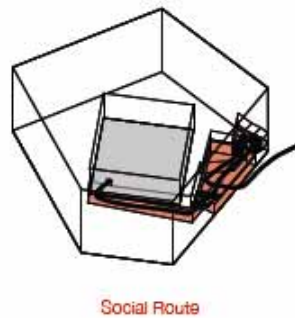
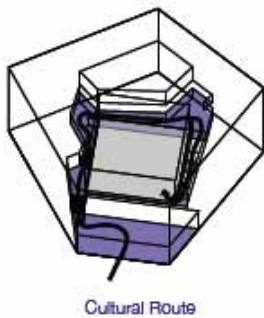
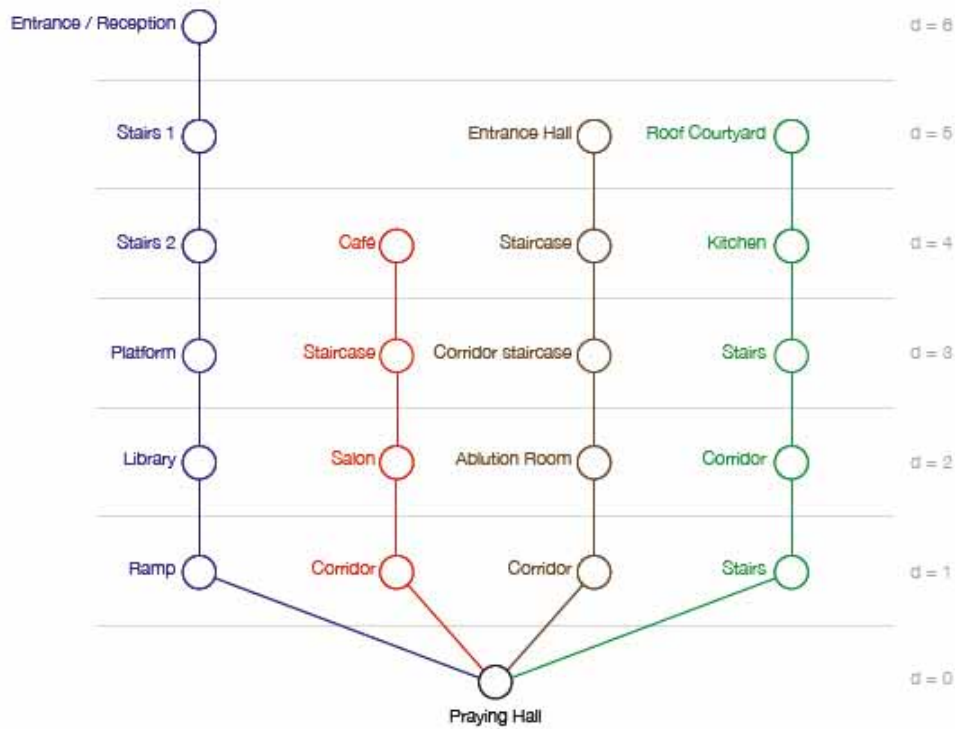

Step depth from the central praying hall

The different routes leading to the praying hall are an important aspect of the project. Through this J-Graph, we wanted to represent the sequences and step depth for each route. In the graph we have not included all spaces of the mosque but instead only those rooms that are part of the routes to the praying hall.

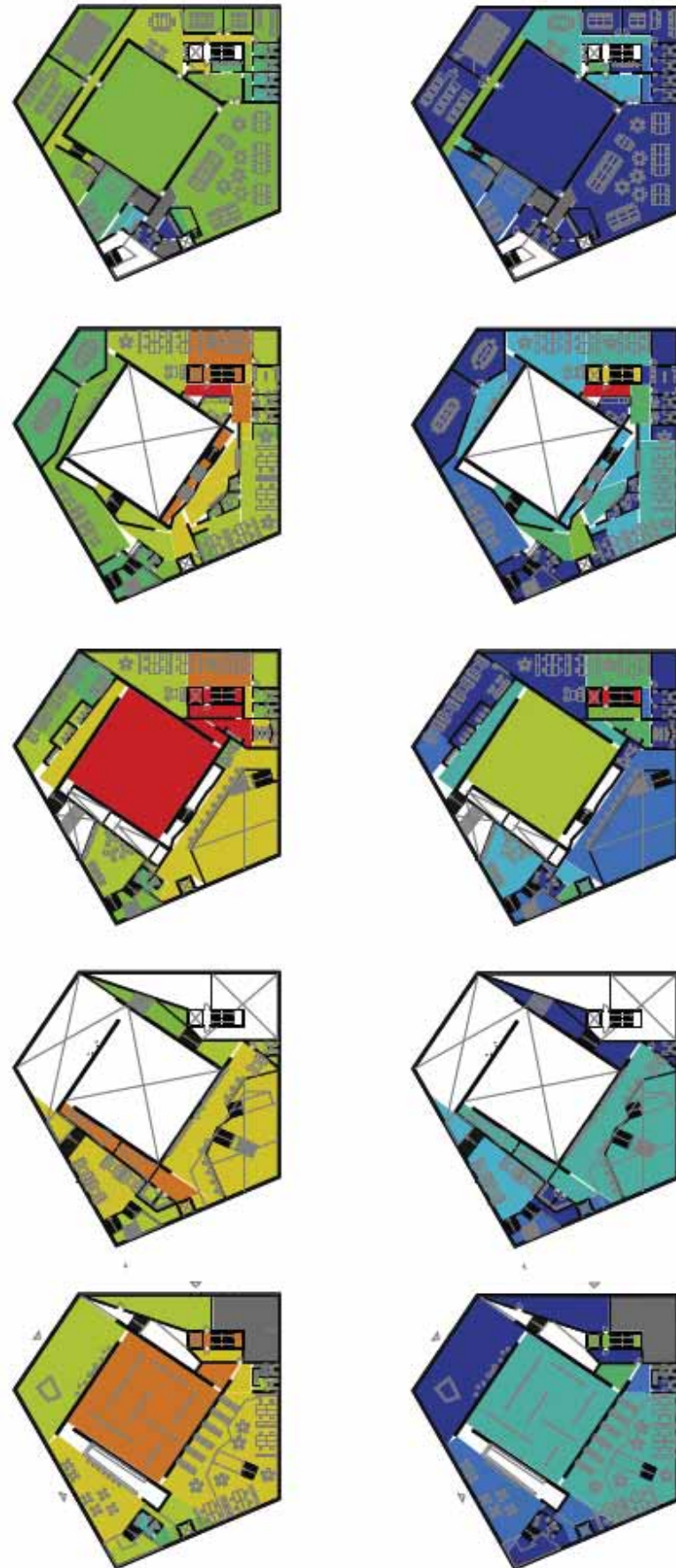

Integration

Choice

Integration and choice

In this analysis, we wanted to see the position of the praying hall in the building and its relation to the other spaces. This was done by drawing convex spaces and then calculating the integration and connectivity.

As we expected the praying hall is one of the most integrated spaces in the mosque. With its four entrances and its central position in the mosque (horizontally and vertically), this was a conscious decision of ours. The choice value of the praying hall is also relatively high. Obviously the staircase has the highest choice value.

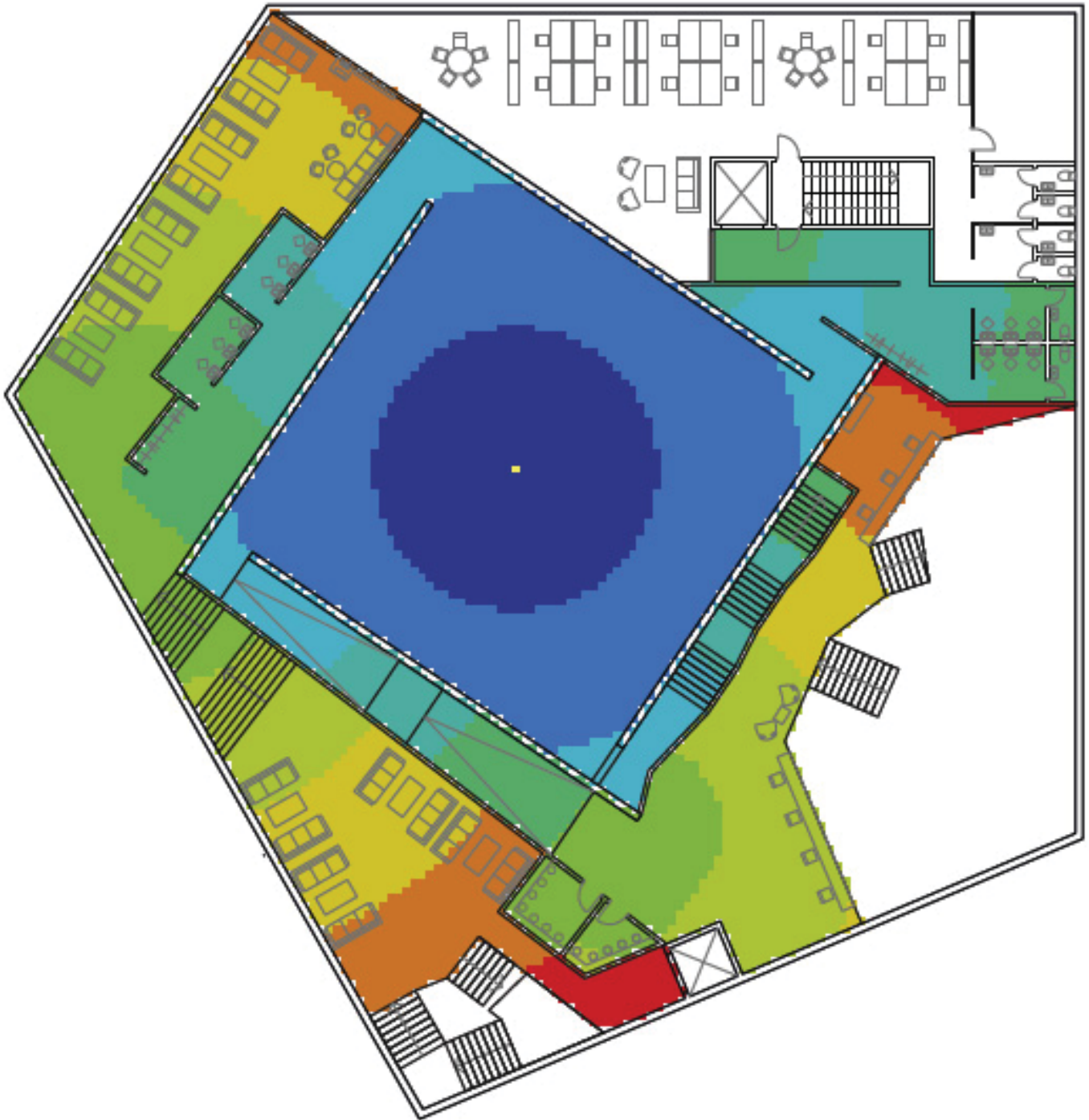

Metric Step Shortest Path from the center of the praying hall

This graph shows us the metric length from the center of the praying hall to the periphery of the same floor. Unfortunately this analysis method can only be performed per floor and thus has a clear limitation. We would like to measure the metric step shortest path from the praying hall to the end of our different routes. The routes stretch over more than one floor so this two-dimensional measurement can only give us visual data for the last parts of our routes.

Despite this fact we can notice that the direct route (from the northern stair case) for example does not contain any red area while the cultural route (ramp south of the praying hall) and the social route does contain a lot of orange and red areas. This strengthens our idea about one of our routes being more pragmatic than the others, leading almost directly to the praying hall. The cultural route, on the other hand, is longer and the experience is elongated.

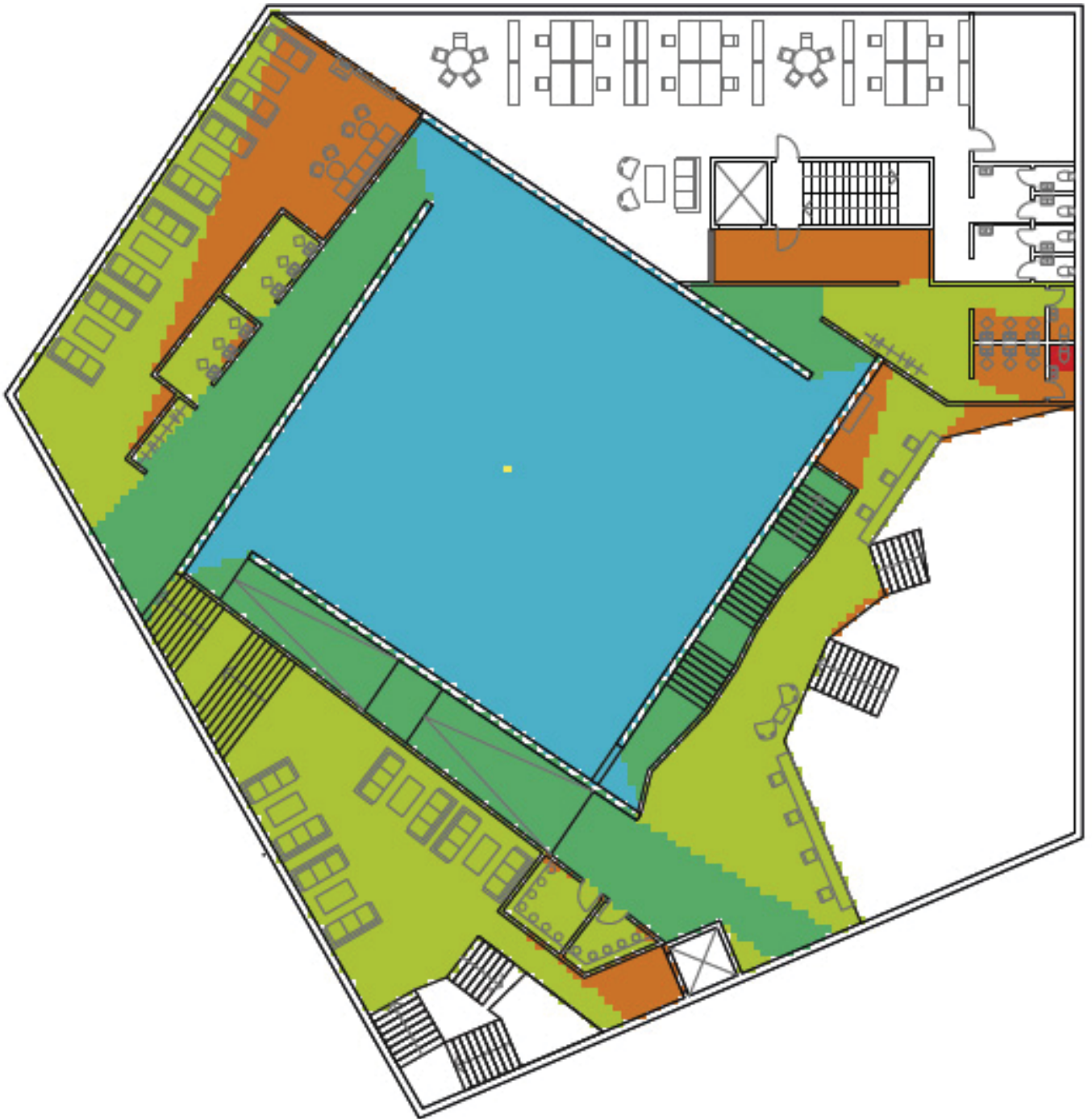

Visual Step Depth from the center of the praying hall

It is interesting to compare this graphic analysis with the previous one. In contrast to the previous analysis, this one shows that the different routes have approximately the same visual step depth (from blue to orange). By combining this result with the previous analysis we can interpret that all three of the routes have a similar kind of language in terms of sequences - although having quite different metric step depth.

In general the different space syntax analyses that were performed on our building from an interior point of view really prove that the main idea, of letting the central praying hall be the most integrated room in the mosque, is working. Also the idea of having different routes with different tempo and depth can be partially proved by using these methods. The limitation of the method, not being able to analyze over more than one floor, makes it not a one hundred percent accurate analysis method for our purpose.

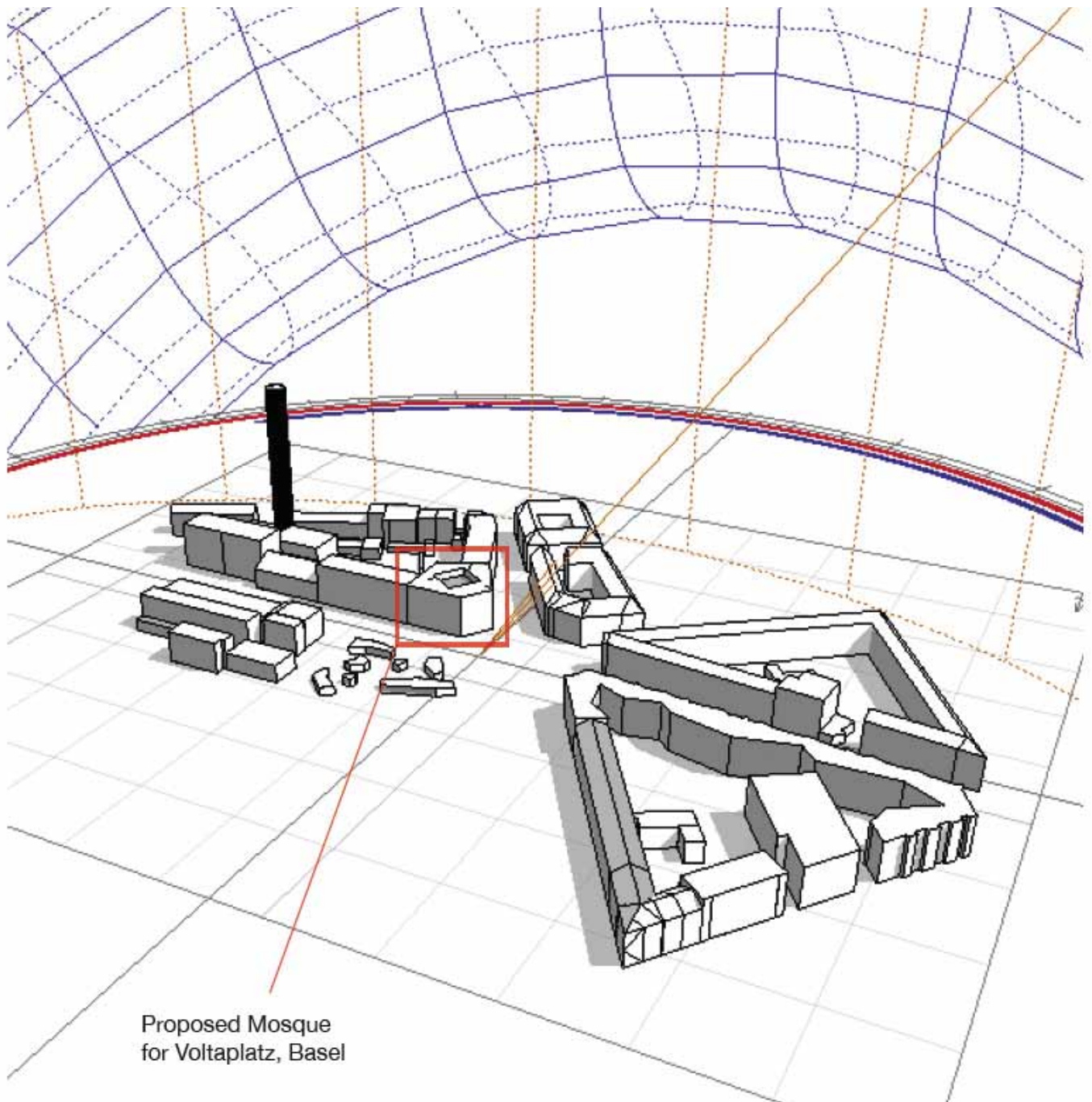

Proposed Mosque
for Voltaplatz, Basel

In this part a shadow analysis was done for the neighbourhood with our added building. The shadow study was performed for two different dates, 1st of June and 1st of December, at three different hours: 9:00, 12:00 and 18:00.

An important aspect of our project is the relationship to the context and the interaction with the surrounding urban spaces. The shadow analysis gave us a tool, and an additional parameter, to understand, refine and improve the volumetric design of the building. For example to extrude or set back parts of the volume to react to the urban space we want to create in front of it. In our case the shadow

study showed us that different small interventions that we were exploring did not really affect the neighbourhood in a major way. That is partially why we decided to maximize the use of the site. This analysis is on the final design of the mosque.

June 1st
Range from 6:00 - 21:00

December 1st
Range from 6:00 - 21:00

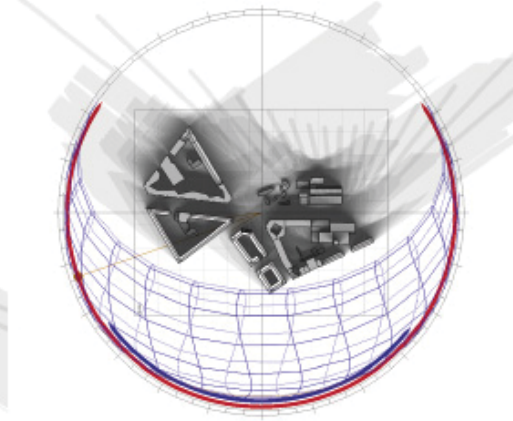
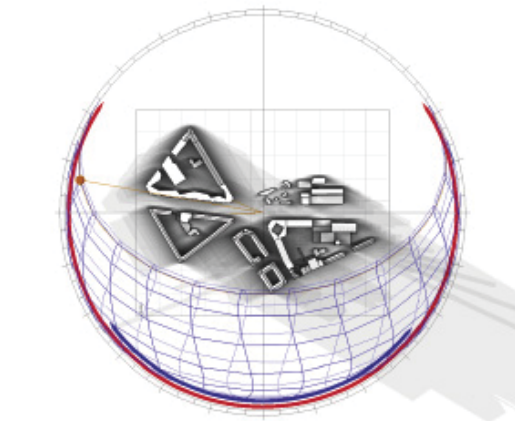

9:00

9:00

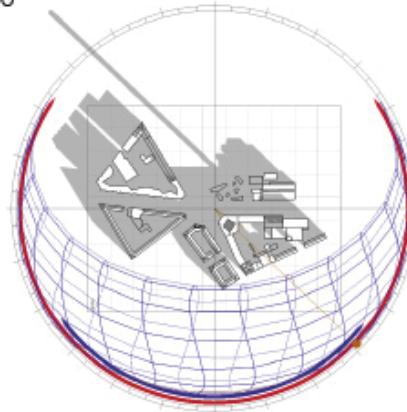
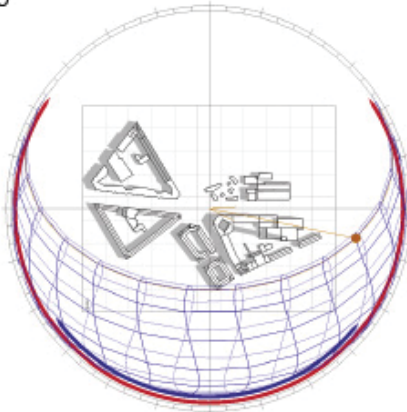

12:00

12:00

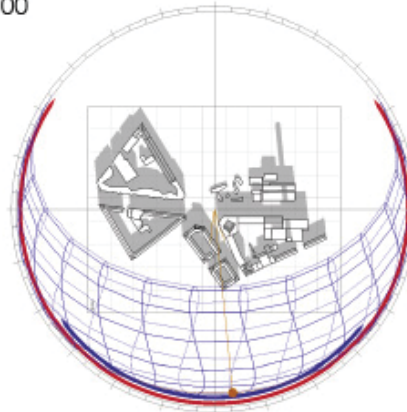
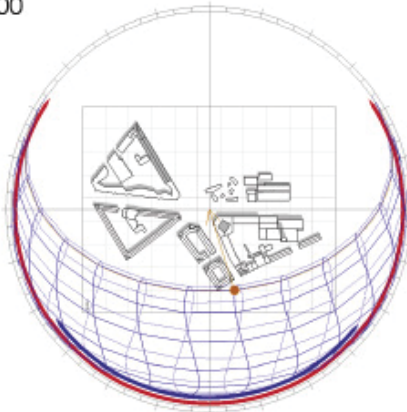

18:00

18:00

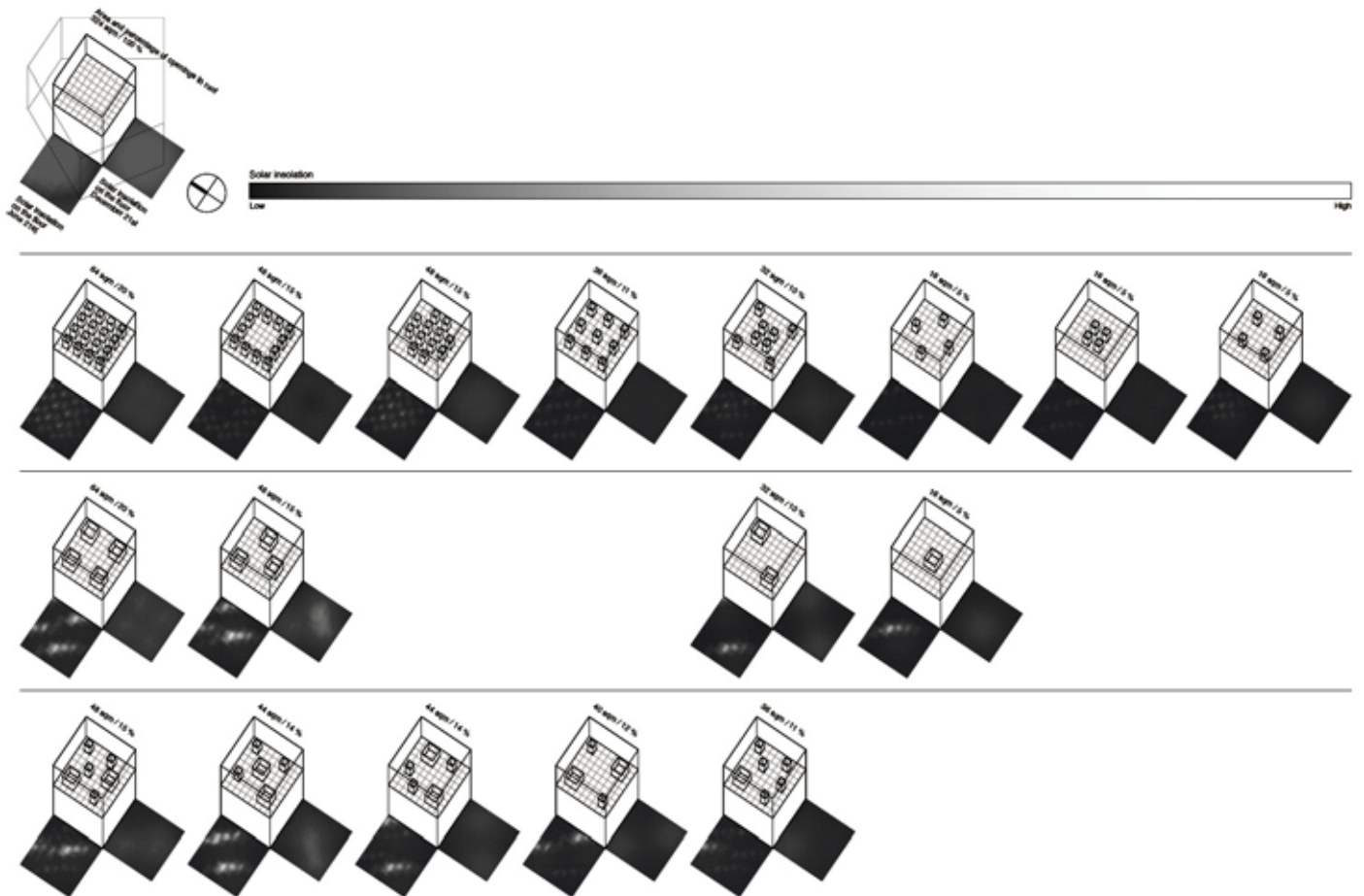

Solar insolation in praying hall

To get daylight in to the praying hall (which is totally encapsulated in the rest of the building) the only source of light can be accessed from the roof. The roof of the praying hall also becomes a terrace on the top floor. To prevent insight from the terrace to the praying space the lanterns have to a height above eye-level.

In this analyze we mapped different sizes, numbers and arrangements of the lanterns. The difficulty was to find a balance between the amount of illumination/sun light to the prayer space and ratio of walkable space on the terrace level - which preferably should not be too dispersed by the lanterns.

To analyze the light impact of the roof openings on the praying space two solar insolation analysis (calculating total, direct and diffuse solar radiation falling on the floor) were performed on the different alternatives for two different dates. The first one was done for June 21st and the second for December 21st. Both analyzes are done in a time span from 06:00 to 21:00.

Complementary to this a daylight analysis should have been performed to not only see the direct solar radiation but also daylight factors and sky illuminance. To do an accurate and providing analysis of this kind a great deal of computer power would have been required.

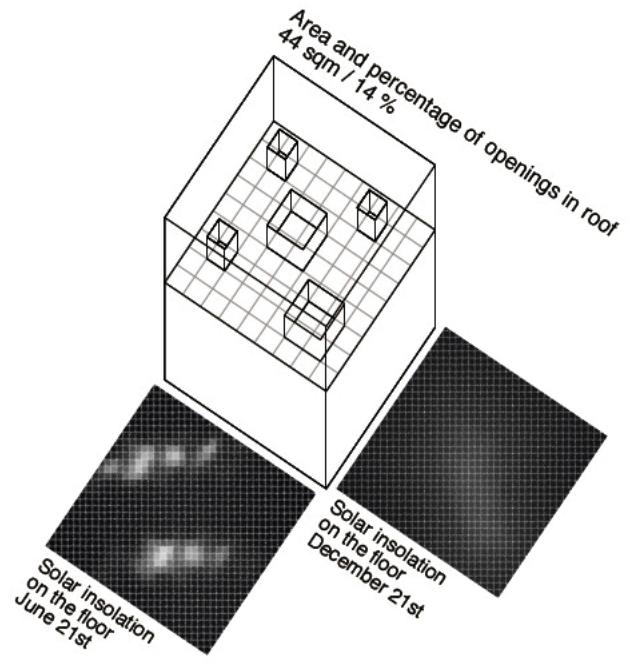
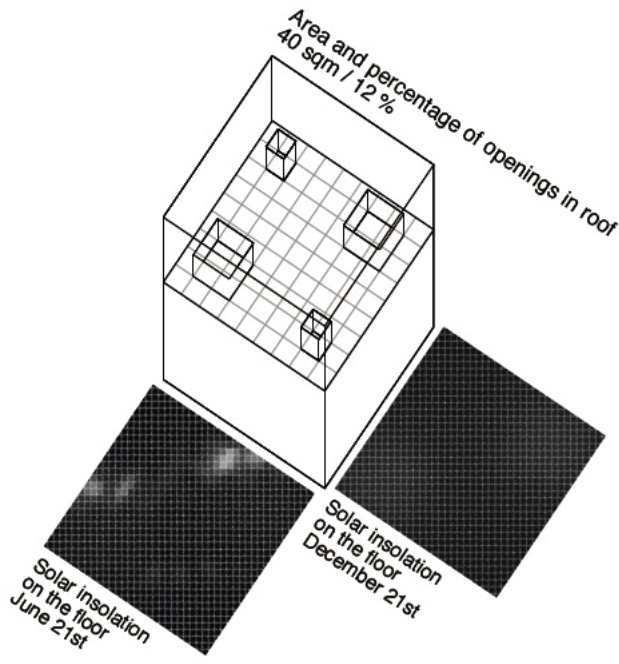
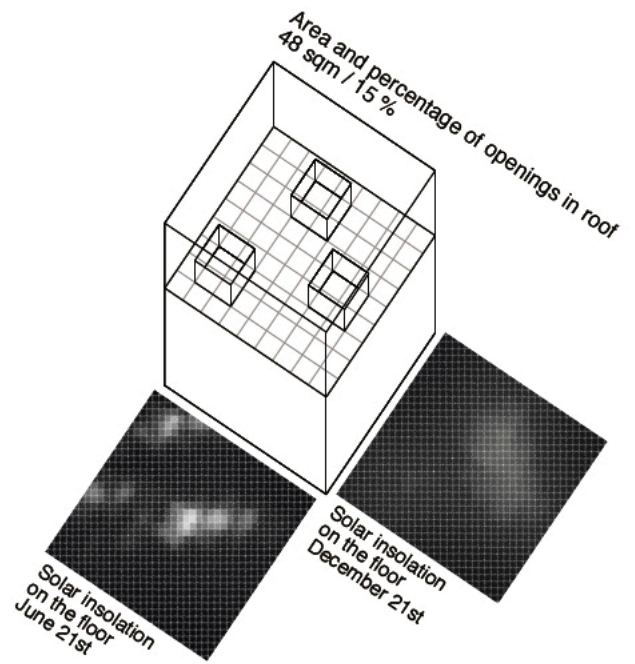
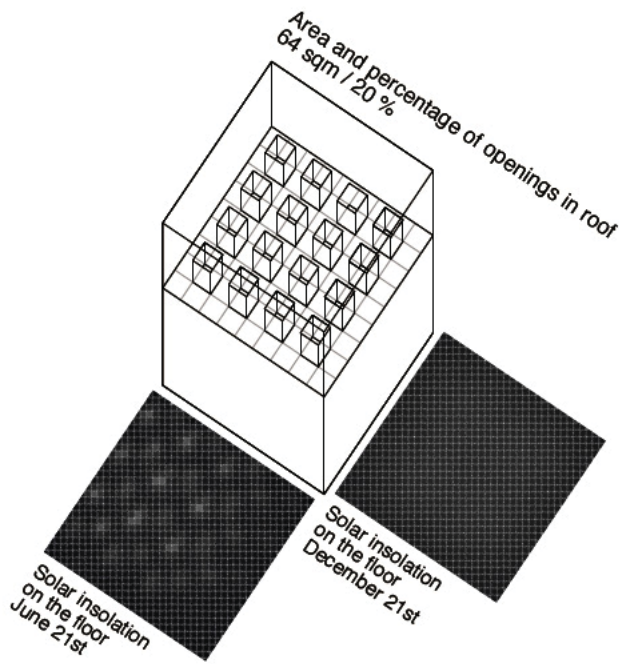

Four alternatives with different numbers, sizes and arrangements of the lanterns

Due to its high area coverage and dispersing effect of the terrace area, the first alternative is disqualified - this despite its smooth and even light distribution. As expected the insolation is much more clear and concentrated in summer than in winter where it is more diffused and spread.

A mixture of different openings sizes is preferred thanks to its variety in illumination and spatial qualities - both inside the praying space and above it. The fourth alternative is probably the best guide for our further development of the lanterns and their formation. It creates a satisfactory and interesting play of light while it at the same time allows a sufficient part of the roof to be usable as terrace. The different sizes and the position of the lanterns also disperse the terrace in a way that creates good and functional spatial conditions.

