

Documentation of the teaching results from the fall semester 2014

Digital Urban Simulation

Reinhard König, Estefania Tapias, and Gerhard Schmitt

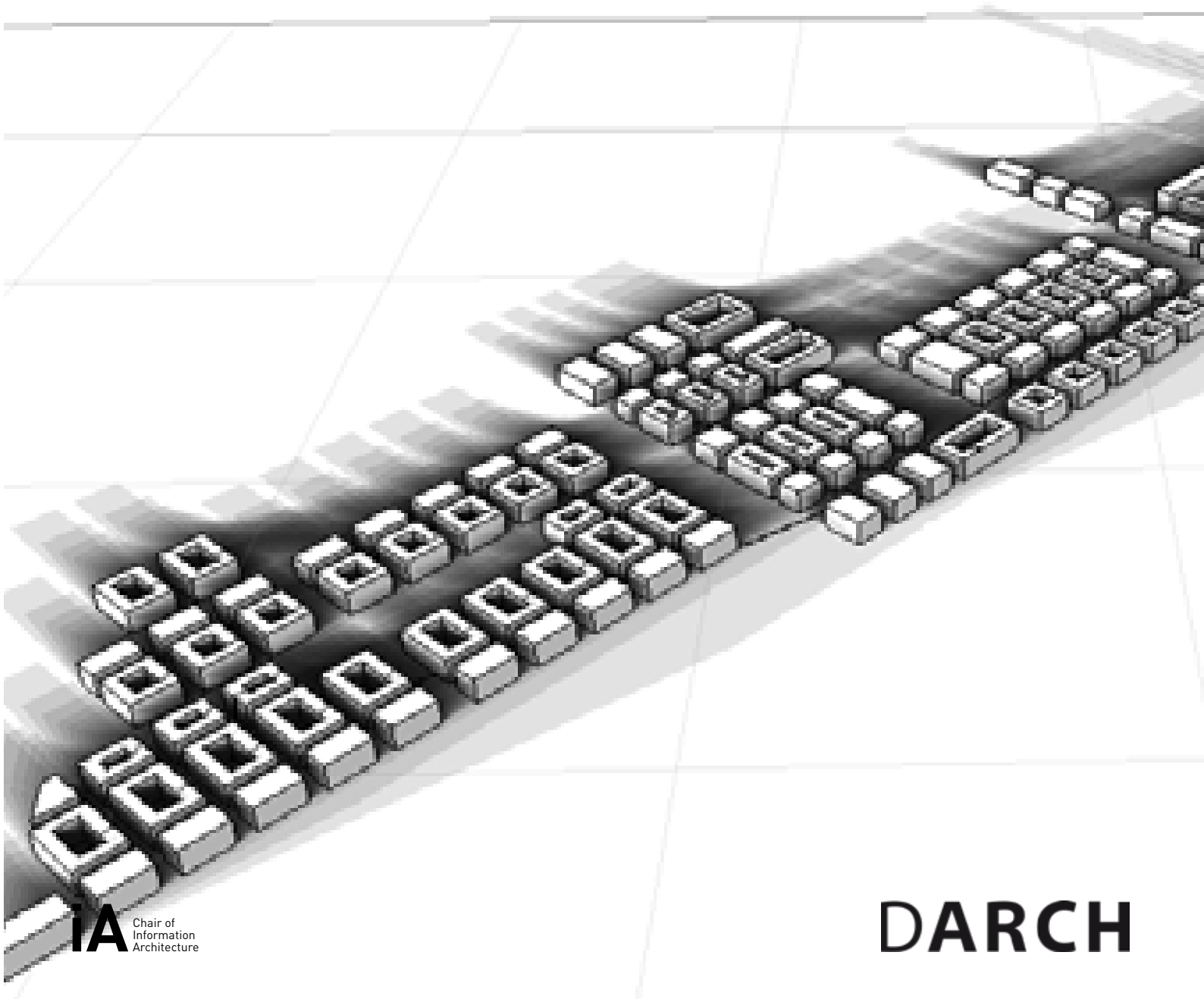

DARCH

Department of Architecture

Chair of Information Architecture

Digital Urban Simulation

Documentation of teaching results

Reinhard König, Estefania Tapias, and Gerhard Schmitt



Chair of Information Architecture

Teaching

Reinhard König, Estefania Tapias, and Gerhard Schmitt

Syllabi

<http://www.ia.arch.ethz.ch/category/teaching/archive/hs2014-new-methods-in-urban-analysis-and-simulation/>

Seminar

Digital Urban Simulation

Students

Masayuki Hattori, Paul Neitzel, Andrea Gonzales Palos, Benjamin Gurtner, Bettina Dobler, Emma Paola Flores Herrera, Irene Urso, Marc Lallemand, Thijs van der Lely, Zlatina Paneva

Published by

Swiss Federal Institute of Technology in Zurich (ETHZ)

Department of Architecture

Chair of Information Architecture

Wolfgang-Pauli-Strasse 27, HIT H 31.6

8093 Zurich

Switzerland

Zurich, May 2015

Layout

Gava Alessandra

Contact

reinhard.koenig@arch.ethz.ch | <http://www.ia.arch.ethz.ch/koenig/>

Cover picture

Front side: Benjamin Gurtner, Shadow Analyse, Winter solstice for Ciminiano, Milan

Back side: Zlatina Paneva, Axial map analysis, Integration, for Zürich Nord

Course Description and Program

Mondays 14:00 – 18:00

063-1357-14 G | 4 ECTS*

Digital Urban Simulation

A solid knowledge of computational methods is an increasingly important key competence for future architects or urban planners. In this course you will learn how to analyze and generate spatial configurations with advanced computational methods.

In a series of theory lectures we explore how designing and planning of cities could become evidence based by using scientific methods. Various exercises will provide training for your skills in working with state-of-the-art yet office proven design tools (Depthmap, Ecotect, and Rhino/Grasshopper). In an integral project work, you will deepen your knowledge in spatial analysis and simulation methods such as Space Syntax using Depthmap software and environmental analysis with the program Ecotect. In addition you will acquire skills for using analysis methods for generative design processes. Therefore we introduce you into the parametric design software Grasshopper for Rhino 3D.

Based on the methods introduced during the semester, you will learn and understand different effects of planning and design interventions on urban life. At the end of the course you will be able to interpret analysis and simulation results, and to apply correspondent computational methods for your own planning projects.

Where:

Lecture, HIT F22 - Value Lab
Exercise, HIT H12

When:

Mondays 14:00 to 18:00

Supervision:

Dr. Reinhard König
Estefania Tapias

reinhard.koenig@arch.ethz.ch
tapias@arch.ethz.ch

- 22.09.2014 Introduction to the course
E1 - Rhino/Grasshopper tutorial
- 29.09.2014 Generative systems workshop
E2 - Generative techniques
- 06.10.2014 Space syntax I
E3 - Convex Map, Axial Map of a small area
- 13.10.2014 Space syntax II
E4 - Depthmap & GIS: Prepare Data -> Import Data -> Analysis methods
- 20.10.2014 Seminar week (no lecture)
- 27.10.2014 Space syntax III
E5 - Rhino/Grasshopper
- 03.11.2014 Empirical studies
E6 - Collect data (evaluate existing materials)
- 10.11.2014 Microclimate analysis I
E7 - Ecotect Tutorial I. Analysis of a small urban area.
- 17.11.2014 Microclimate analysis II
E8 - Rhino/Grasshopper
- 24.11.2014 Best practice examples - Guest lecture
Final consultation
- 01.12.2014 Final iA critique
Combined critique with the other iA courses

* Total 120 h = 4 ECTS

Exercises 25% (documentations)

Presentation 25% (project at the end)

Written documentation 50% (project)

The most recent outline will be found on www.ia.arch.ethz.ch

Content

Analysis of My Neighborhood

Student: Masayuki Hattori

p.9

Optimization of window dimensions to solar gains

Student: Paul Neitzel

p.21

Khayelitsha Re-Clustering

Student: Andrea Gonzales Palos

p.29

Urban Planning in Milan/Cimiano

Student: Benjamin Gurtner

p.39

Rosengartentram & Rosengartentunnel

Student: Bettina Dobler

p.45

BT Section Khayelitsha- Urban Relations

Student: Emma Paola Flores Herrera

p.53

Commerce and industry of Zurich – An analysis of its transport connection and centrality

p.59

Student: Irene Urso

Applying the Solar Envelope Concept to the Reorganization and Massing of the Hunziker Areal with Grasshopper-Geco and Ecotect

p.71

Student: Marc Lallemand

BT Section

p.81

Student: Thijs van der Lely

New City District - Zürich Nord

p.91

Student: Zlatina Paneva

Analysis of My Neighborhood

Student: Masayuki Hattori

1. Summary:

I analysed a current site where some people feel inconvenient, and clarified problems of the current site which are the followings: paths are complicated, there are some dead end roads; due to complicated paths, some children may have trouble going to school. In order to solve this problem, it is required to have higher Intellegibility, low step depth, less shadow on the roads and high solar radiation on the roads.

In this study, I found that we should arrange buildings regularly when high Intelligibity and low Step Depth are required for the city. For the vertical plan, the lower the buildings are, the smaller the effects of the shadow on the roads are. But, there is a little difference between a vertical plan which contains only 2-3 storied buildings, and the vertical plan which contains only 4-7 storied buildings. Considering a capacity of the buildings, the vertical plan which contains only 4-7 storied buildings is better than the other vertical plans. Finally I concluded that the most suitable plan for this city is a plan where there are middle-rise buildings in a regular arrangement.

2. Motivation

I lived in Honancho, Shinjuku-ku, Tokyo, Japan when I was 6-8 years old. I always felt that for residents this city was inconvenient for residents. That is why I analysed my Neighbourhood and proposed my plans.

3. Current Situation of Site (Depthmap Analysis):

By using Depthmap, I analysed Integration, Connectivity (Axial), and Intelligibility which is a correlation between Integration and Connectivity.

As shown in Fig. 6, Intelligibility of this site was not good, 0.405. This low Intelligibility was one of reasons of the inconvenience.



Fig. 1 Japanese Map

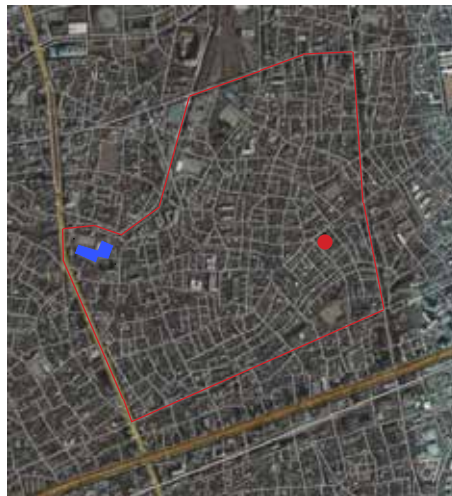

Fig. 2 Satellite Photograph of Site



Fig. 3 Model Map of Site

Table I Color Range of Properties of Axial Analysis in Current Site

	Min (Blue)	Max (Red)
Integration	0.87	1.90
Connectivity (Axial)	1	20

Next, I analysed Area, Connectivity (Isovist), and Step Depth from the school (a red marked place in Fig.9) with the isovist analysis. Results were shown in Figs. 7-9. The color ranges of Area, Connectivity (Isovist), and Step Depth were shown in Table II. The Figure of Area (Fig. 7) was very similar to the figure of connectivity (Isovist) (Fig. 8). This analysis generally matched my experience. The most outside roads were main roads in this city. That is why Area, and Connectivity (Isovist) on these roads were relatively high compared with other roads.

In some places, a value of Step Depth was 15. This means that people who live there need to turn 15 times to go to school. This value is too high for children, therefore we should propose plans where Step Depth is low.

Table II Color Range of Properties of Isovist Analysis in Current Site

	Min (Blue)	Max (Red)
Area	23.99 m ²	17353 m ²
Connectivity (Isovist)	2	2313
Step Depth from school	0	15

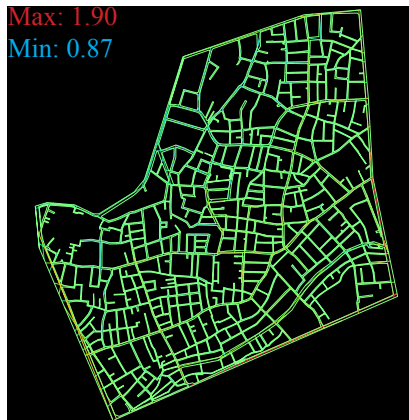

Fig. 4 Integration in Current Site

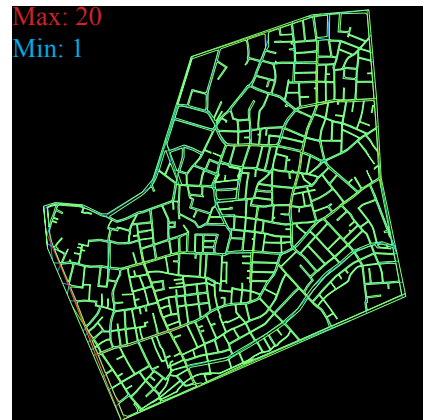

Fig. 5 Connectivity (Axial) in Current Site

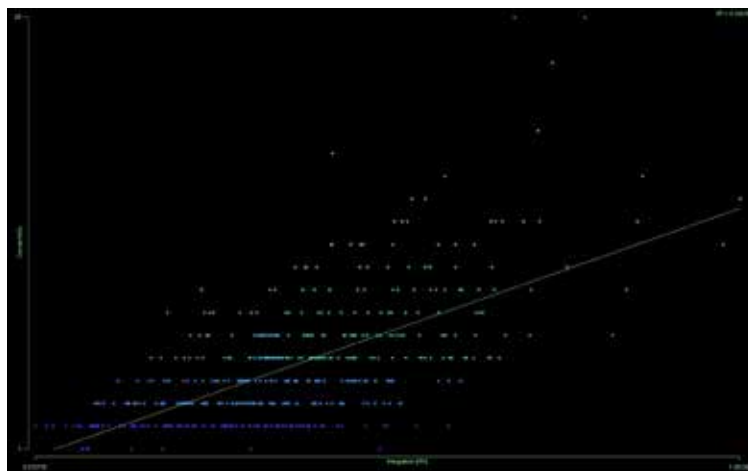

Fig. 6 Intelligibility in Current Site

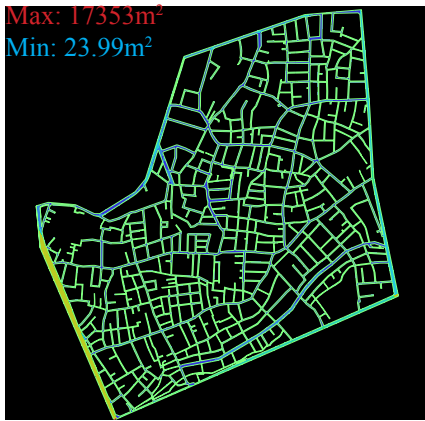

Fig. 7 Area in Current Site

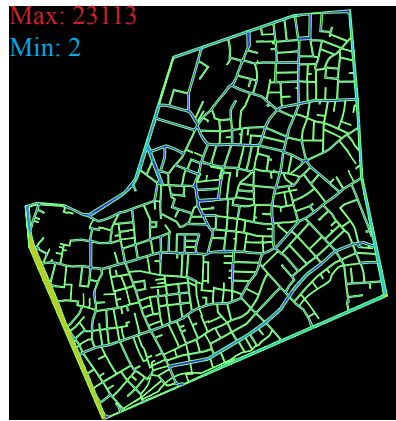

Fig. 8 Connectivity in Current Site



Fig. 9 Step Depth in Current Site

4. Depthmap Analysis for Horizontal Plans:

Considering the requirements for the current site, I proposed two extreme examples for a horizontal plan as shown in Fig. 10 (Horizontal Plan 1) and Fig. 11 (Horizontal Plan 2). In these plans, I set that width of each road is constant (10 m). Figure 10 shows a random arrangement where shape of the buildings was very strange, and there were a lot of dead ends of the roads. Figure 11 shows a regular arrangement where shape of buildings was simple, only the rectangle and triangle shape, and there was no dead end of the roads.

Hypotheses for Depthmap analysis were as follows,

In the axial analysis

- a) When the horizontal plan is random --> low Intelligibility because ways from one place to another are unclear.
- b) When the horizontal plan is regular --> high Intelligibility because ways from one place to another are clear.

In the isovist analysis

- c) When the horizontal plan is random --> high Step Depth from the school because we have to turn many times to go to the school.
- d) When the horizontal plan is regular --> low Step Depth from the school because we don't have to turn many times to go to the school

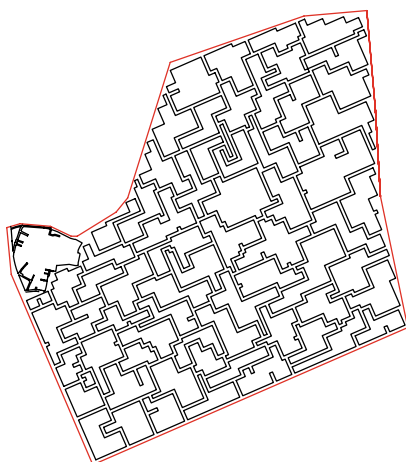

Fig. 10 Horizontal Plan 1
(Random Arrangement)

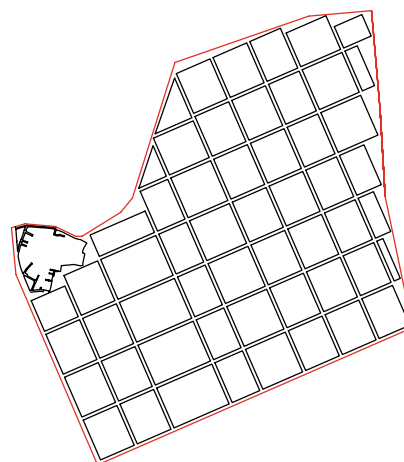

Fig. 11 Horizontal Plan 2
(Regular Arrangement)

4-1. Axial Analysis:

First of all, I analysed Integration, Connectivity (Axial), and Intelligibility in the random arrangement, and in the regular arrangement by using Depthmap. Results of this analysis were shown in Figs. 12-14 (Random Arrangement), and in Figs. 15-17 (Regular Arrangement). In order to compare these two arrangements, I fixed color ranges of Integration and Connectivity (Axial). These color ranges were shown in Table III. Almost all lines in Figs. 12-13 (Random Arrangement) were blue because of fixing the same color range as Figs. 15-16 (Regular Arrangement). Intelligibility in the random arrangement was very low, 0.266, therefore, this plan is not suitable for the city. On the other hand, in the regular arrangement, the figure of Integration (Fig. 15) was similar to the figure of Connectivity (Fig. 16), then Intelligibility was very high, 0.781. High intelligibility means that it is easy for newcomers to go to any places. Then, hypotheses a), and b) were confirmed.

Table III Fixed Color Range of Properties of Axial Analysis in Random and Regular Arrangement**

	Min (Blue)	Max (Red)
Integration	0.5	4.5
Connectivity (Axial)	1	19

** The original color ranges in the random arrangement was between 0.53 and 1.19 (Integration), and between 1 and 15 (Connectivity (Axial)).

4-2. Isovist Analysis:

In this section, I analysed Area, Connectivity (Isovist), and Step Depth from the school (a red marked place in Figs. 20 and 23) by using Depthmap. Results of this analysis were shown in Figs. 18-20 (Random Arrangement), and in Figs. 21-23 (Regular Arrangement). Color ranges of Area, Connectivity, and Step Depth were fixed as shown in Table IV.

Table IV Fixed Color Range of Properties of Isovist Analysis in Random and Regular Arrangement***

	Min	Max
Area	35.78 m ²	26099 m ²
Connectivity (Isovist)	5	3486
Step Depth from school	0	15

*** The original color ranges in the random arrangement was between 35.78 m² and 18334 m² (Area), and between 5 and 2442 (Connectivity (Isovist)). The original color range of Step Depth from school in the regular arrangement was between 0 and 4.

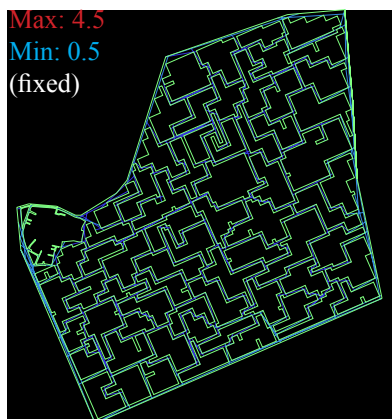

Fig. 12 Integration in Random Arrangement



Fig. 13 Connectivity in Random Arrangement

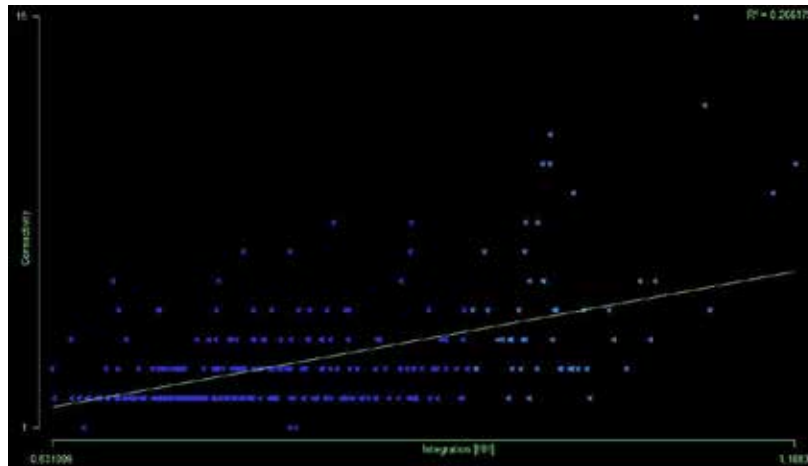

Fig. 14 Intelligibility in Random Arrangement

As mentioned in the case of the current site, figures of Area (Figs.18 and 21) were very similar to figures of Connectivity (Isovist) (Figs. 19 and 22) respectively. For Step Depth (see Fig. 20), people who live in some places have to turn 15 times to go to the school in the random arrangement, then, hypothesis c) was confirmed. On the other hand, in the regular arrangement, the maximum of Step Depth from the school was 4 (see Fig. 23), therefore, we can go to the school easily, then, hypothesis d) was confirmed.

5. Ecotect Analysis for Vertical Plans:

In this chapter, I simulated effects of the height of the buildings on the roads (Shadow and Solar Radiation) by using Ecotect. I considered following vertical plans (Figs. 24-26).

- Vertical plan 1: only 2-3 storied buildings (8-12 m)
- Vertical plan 2: only 4-7 storied buildings (12-25 m)
- Vertical plan 3: mainly 4-7 storied buildings, and a few very high buildings (70 m, and 85 m)

I analysed only the vertical plans in regular arrangement, that is, I didn't analyse in the random arrangement because I wanted to see the effects of height of the buildings. The analysis of the regular arrangement was enough to see these effects. In this simulation, I used a weather data of Tokyo (Latitude: 36° 2' N, Longitude: 140° 4' E). I simulated shadow ranges from 8 a.m. to 3:45 p.m. The reason why the end of analysis time was 3:45 p.m. was that the sunset on winter solstice is before 4 p.m. In the northern hemisphere, the summer solstice is 22nd June, and the winter solstice is 22nd December. Hypotheses for Ecotect analysis were as follows.

In the shadow analysis

- a) the length of the shadow on winter solstice is longer than that on the summer solstice.
- b) the higher the buildings are, the longer the shadow is.

In the solar radiation analysis

- c) the values of the solar radiation on the roads on winter solstice are smaller than those on the summer solstice.
- d) the higher the buildings are, the smaller the solar radiation on the roads

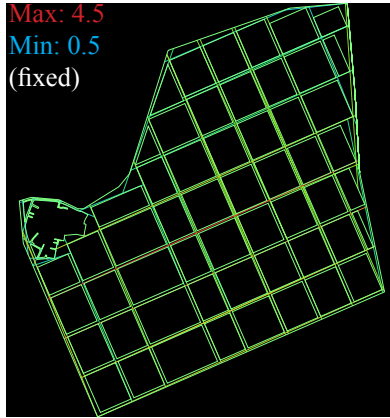

Fig. 15 Integration in Regular Arrangement

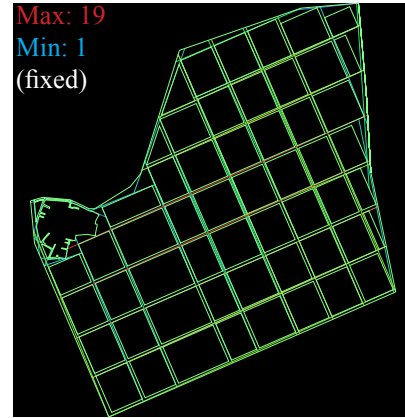

Fig. 16 Connectivity in Regular Arrangement

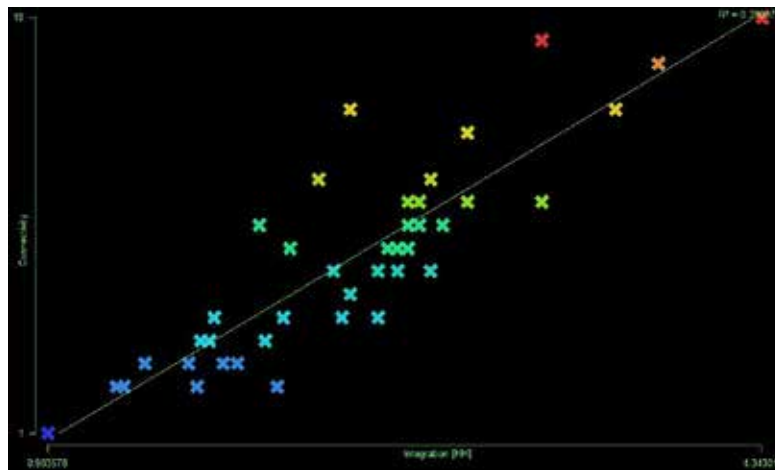

Fig. 17 Intelligibility in Regular Arrangement

5-1. Shadow Analysis:

I simulated the shadows of the buildings on the summer solstice, and on the winter solstice. Results of this simulation were shown in Figs. 27-29 (the summer solstice), and in Figs. 30-32 (the winter solstice). Figure 27 was very similar to Fig. 28 because, in summer, the height of the sun is high, and the shadow does long. Then, in summer, influences of the height of the buildings were small. In Fig. 32, the shadows of the very high buildings influenced other buildings. This may cause a conflict between residents. Whether the sun light enter in their house or not is an important issue for many people. In general, compared with the same place, the results of this simulation on the winter solstice were similar to those on the summer solstice, but shadow length on the winter solstice became longer than that on the summer solstice because the height of the sun in winter is lower than in summer, then hypothesis a) was confirmed. For hypothesis b), it is hard to see it from these figures, but obvious from the common sense.

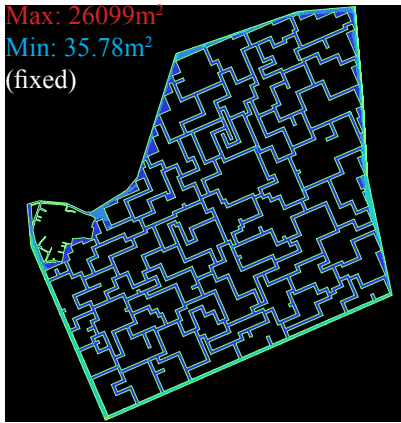

Fig. 18 Area in Random Arrangement

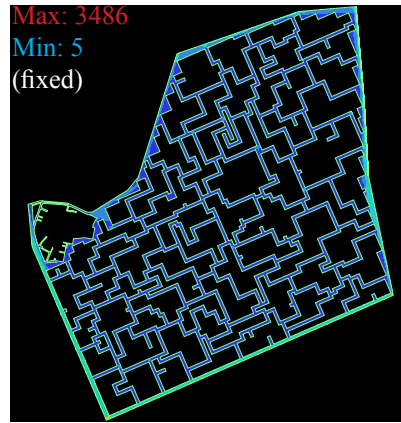

Fig. 19 Connectivity in Random Arrangement



Fig. 20 Step Depth in Random Arrangement



Fig. 21 Area in Regular Arrangement

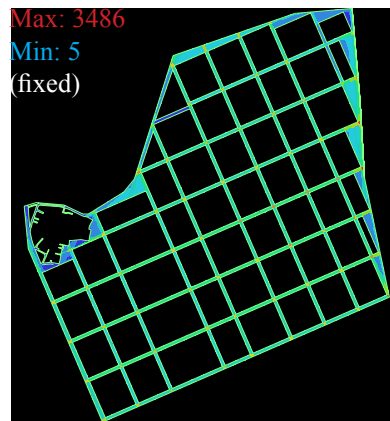

Fig. 22 Connectivity in Regular Arrangement

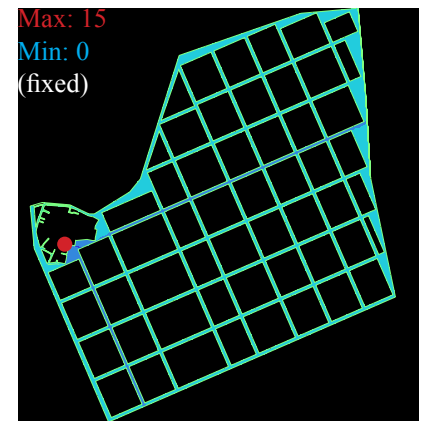

Fig. 23 Step Depth in Regular Arrangement

5-2. Solar Radiation Analysis:

Next, I simulated the solar radiation on the roads on the summer solstice, and on the winter solstice. Results of this simulation were shown in Figs. 33-35 (the summer solstice), and in Figs. 36-38 (the winter solstice). Values of this simulation were the daily average. The maximum of the solar radiation on the summer solstice was 5400 Wh, and the minimum was 400 Wh. On the other hand, the maximum of the solar radiation on the winter solstice was 2820 Wh, and the minimum was 120 Wh. Then, hypothesis c) was confirmed. As shown in Figs. 33-35 (the summer solstice), the roads of the vertical plan 1 had the highest radiation among them as well as the case on the winter solstice (see Figs. 36-38). In the both seasons, the results of the vertical plan 2 and plan 3 (see Figs.34-35 and 37-38) were similar. This means that, in the city which contains mainly 4-7 storied buildings, the effects of the very high buildings on the roads are small, then hypothesis d) was not confirmed. However, as shown in Figs. 29, and 32, the effects of the very high buildings on other buildings were high, therefore the vertical plan 3 may not be suitable for this city.

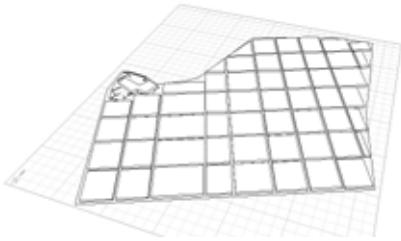

Fig. 24 Vertical Plan 1

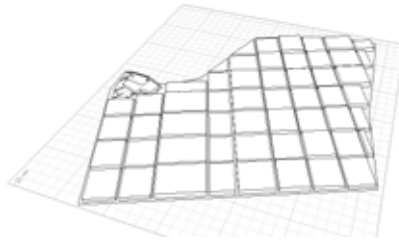

Fig. 25 Vertical Plan 2

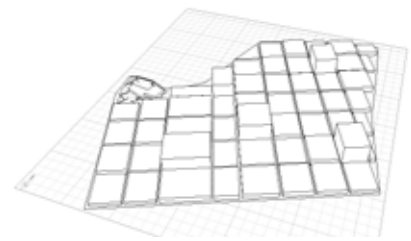

Fig. 26 Vertical Plan 3

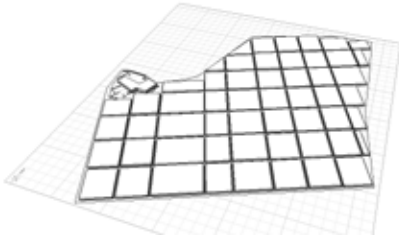

Fig. 27 Shadow Analysis in Summer (Vertical Plan 1)

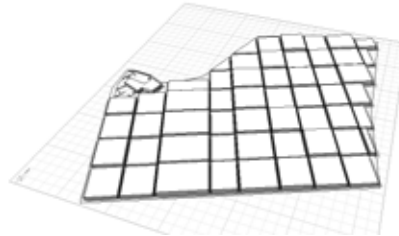

Fig. 28 Shadow Analysis in Summer (Vertical Plan 2)

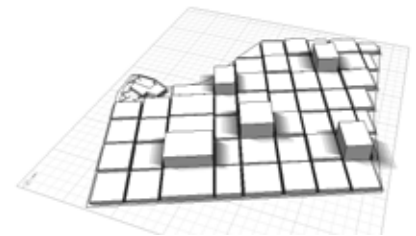

Fig. 29 Shadow Analysis in Summer (Vertical Plan 3)

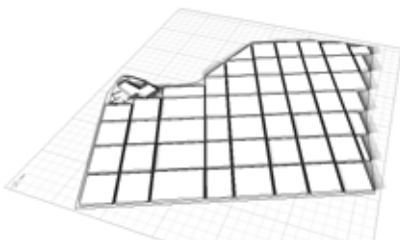

Fig. 30 Shadow Analysis in Winter (Vertical Plan 1)

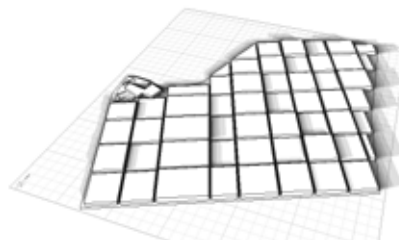

Fig. 31 Shadow Analysis in Winter (Vertical Plan 2)

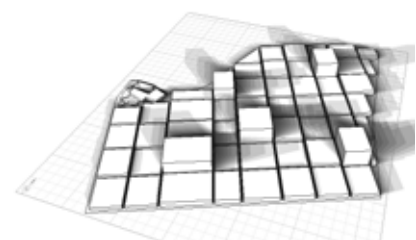

Fig. 32 Shadow Analysis in Winter (Vertical Plan 3)

6. Discussion and Conclusion:

What I found from the two analyses are as follows,

In Depthmap analysis,

-Random arrangement: low Intelligibility, and high Step Depth (x)

-Regular arrangement: high Intelligibility, and low Step Depth (O)

--> The regular arrangement is better than the random arrangement in terms of the safety for children and the easy management.

In Ecotect analysis,

-Vertical plan 1 (only 2-3 storied buildings): a few effects of the shadow on the roads (O)

-Vertical plan 2 (only 4-7 storied buildings): some effects of the shadow on the roads (Δ), but a little difference from Vertical plan 1

-Vertical plan 3 (Vertical plan 2 + very high buildings): some effects of the shadow on the roads (Δ), but bad scenery (x)

--> The vertical plan 1 had the less effects on the roads than the vertical plan 2, but there was a little difference between them. Considering a capacity of the buildings, the vertical plan which contains only 4-7 storied buildings is better than the other vertical plans. Considering these things, I concluded that we should design a combination of the horizontal plan 2 (Regular Arrangement) and the vertical plan 2 (Middle-rise Buildings).

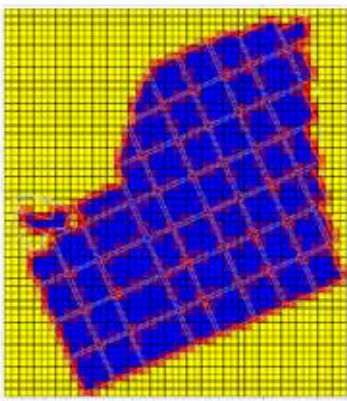

Fig. 33 Solar Radiation Analysis in Summer (Vertical Plan 1)

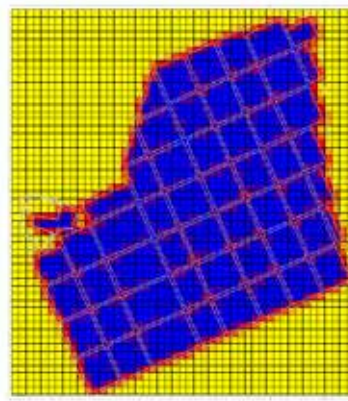

Fig. 34 Solar Radiation Analysis in Summer (Vertical Plan 2)

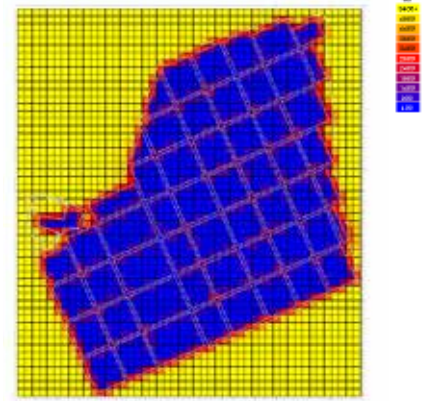

Fig. 35 Solar Radiation Analysis in Summer (Vertical Plan 3)

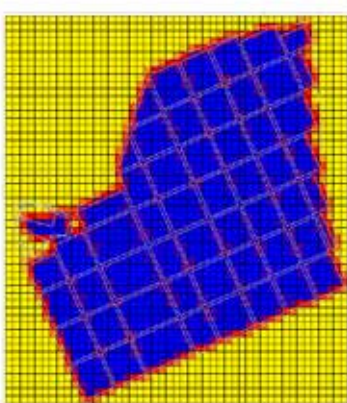

Fig. 36 Solar Radiation Analysis in Winter (Vertical Plan 1)

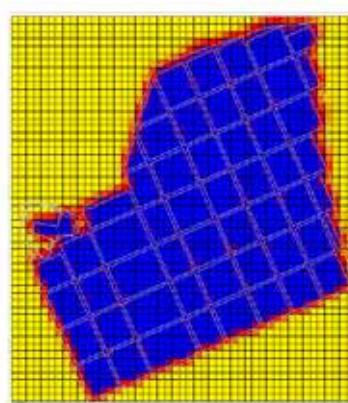

Fig. 37 Solar Radiation Analysis in Winter (Vertical Plan 2)

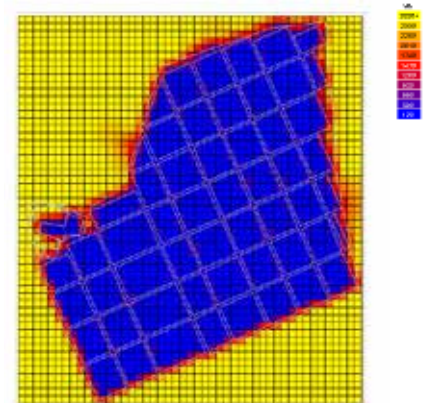

Fig. 38 Solar Radiation Analysis in Winter (Vertical Plan 3)

In the real world, Barcelona in Spain (Fig. 39), and Kyoto in Japan (Fig. 40) are examples of the regular arrangement city, on the other hand Fez in Morocco (Fig. 41), and Venezia in Italy (Fig. 42) are examples of the random arrangement cities. Of course, there are some advantages in the random arrangement (e.g. it is easy to prevent enemies from attacking), but, in terms of the management of the city, the regular arrangement is better than the random arrangement.



Fig. 39 Barcelona in Spain



Fig. 40 Kyoto in Japan



Fig. 42 Fez in Morocco



Fig. 41 Venezia in Italy

Optimization of window dimensions to solar gains

Student: Paul Neitzel

Introduction

Better glass production and processing techniques as well as improvements in the glass characteristics made it possible to increase the glass fraction on building facades drastically in the last decades. This is a very appreciated development, because increased daylight contributes a better part to the user comfort. However a high percentage of transparent facade causes an increase in solar gains, which is an advantage in winter, but can be a disadvantage in summer. If the high solar gains can not be counter acted by night ventilation the building needs to be air conditioned. In order to keep the energy consumption of a building at a minimum, not only should the heating loads but also the cooling needs to be minimized. For this reason the project attempts to optimize the window dimensions individually to meet the optimal solar gains. If a building is air conditioned nearly all glass fractions of the facade can be realized. It is only a matter of cooling load to keep the room temperatures within the comfort zone, even during hot summer days. However, this study aims to examine the case, where no active cooling should be necessary. We set the maximum floor specific external gain that can be counter acted by night cooling to 7 W/m^2 . From this boundary condition we calculate backwards what the individual window dimensions need to be to meet the given condition for different climatic regions (Zurich, southern Italy and northern Scotland). A brief description of the analysis, a before and after view on the investigated sites and a comparison of the calculated factor f with latitude is given in the following.



View on the investigated building from the crossroads of Herdernstrasse and Bullingerstrasse.

https://www.stadt-zuerich.ch/hbd/de/index/ueber_das_departement/medien/medienmitteilungen/2014mai/140526a.html

How can the window dimensions be adapted in a way that overheating in summer can be prevented without air conditioning?

Analysis

The five floors and the corresponding windows as well as the other part of the complex and the surrounding buildings are created in Grasshopper and exported as meshes to Ecotect. With the solar access analysis the total radiation on the window meshes was calculated. The analysis was carried out for the month of July, because overheating is not only depending on the incident radiation, which

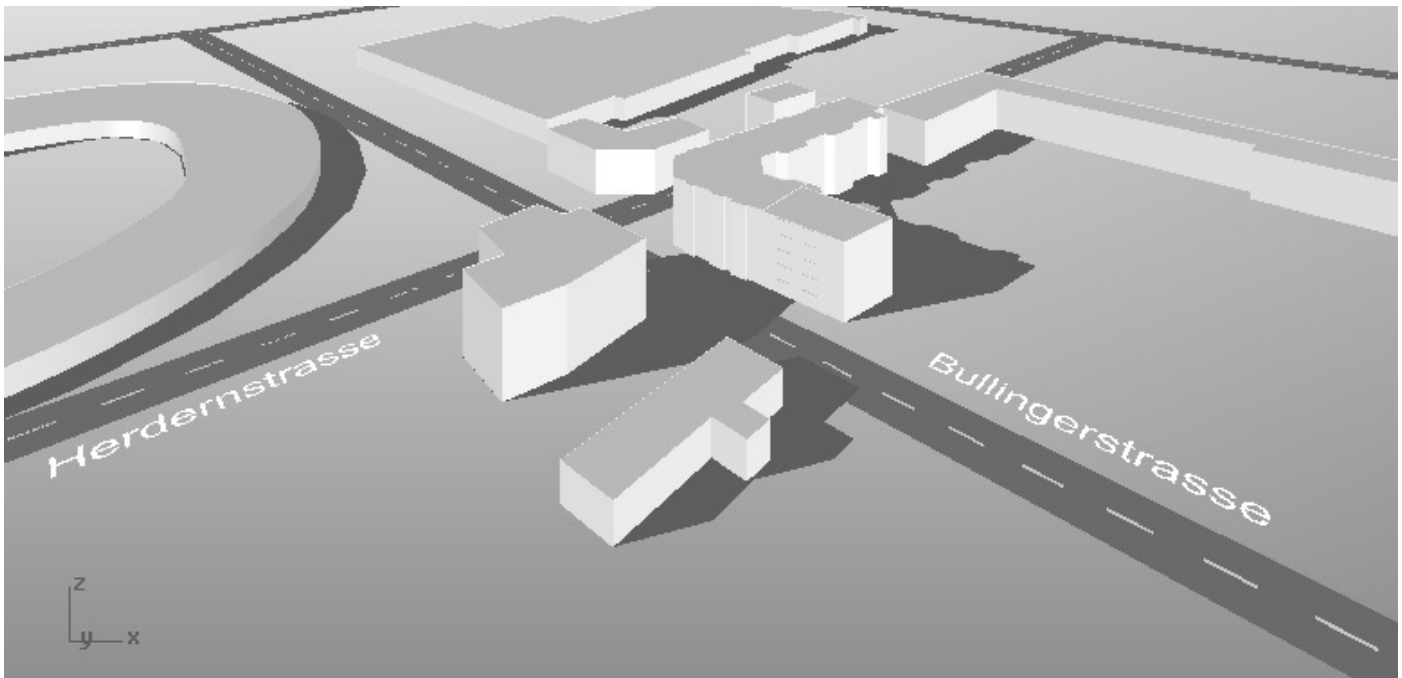

The investigated site will be completed in 2018. It is set opposite of the stadium Letzigrund. The examined part of the building complex is the south eastern wing on Bullingerstrasse.

has its peak on 21st of June, but also depends on the surrounding as well as the building temperature, which has a maximum shifted in time from the maximum of incoming radiation. As a measure of radiation the average hourly values for the time period from 8 a.m. to 6 p.m. were calculated. To answer the question posed in the beginning a limit for the maximum energy per floor area needs to be set. I choose the value of 7 W/m^2 , which is the threshold value for internal gains in a building without air conditioning. In order to adapt the window dimensions in a way that the total area specific radiation input does not exceed the threshold value a factor f is calculated in the following way.

$$f = \frac{7 \frac{\text{W}}{\text{m}^2}}{g f_c I_{\text{tot}} \frac{A_{\text{window}}}{A_{\text{room}}}}$$

The g -value corresponds to the fraction of radiation that enters through the glass including direct transmission and secondary heat dissipation of the glass. Here I used a value of 0.7, which is an average value for double glazing with low e -coating. The factor f_c accounts for the reduction of

incoming solar radiation of the sunshade. 0.25 is a typical value for external blinds. In a second step the original width of each window was weighted with the factor f and the solar access analysis was repeated. That way a uniform solar heating load per area of 7 W/m^2 for every room was obtained. The adapted window sizes and the total incoming radiation expressed in Wh/h is shown in following the results section. The above specified analysis was not only carried out for Zurich, but to evaluate the influence of latitude on the window dimensions two locations one in southern Italy and the other in northern Scotland were selected.

Building Site

The study is conducted on a building project on Herdernstrasse in Zurich, which is currently in the preliminary design study phase. The architects planned on realizing a reasonably priced living and business complex including studios and kindergarten with a Minergie-P-ECO standard. For the analysis the southeast wing of the complex was chosen and for time limiting reasons a strongly simplified model was built. The five floors have an identical ground plot and the same window sizes. The other part of the complex and the surrounding buildings on Bullingerstrasse and Herdernstrasse are modeled by extruding the ground plot to the average building height.

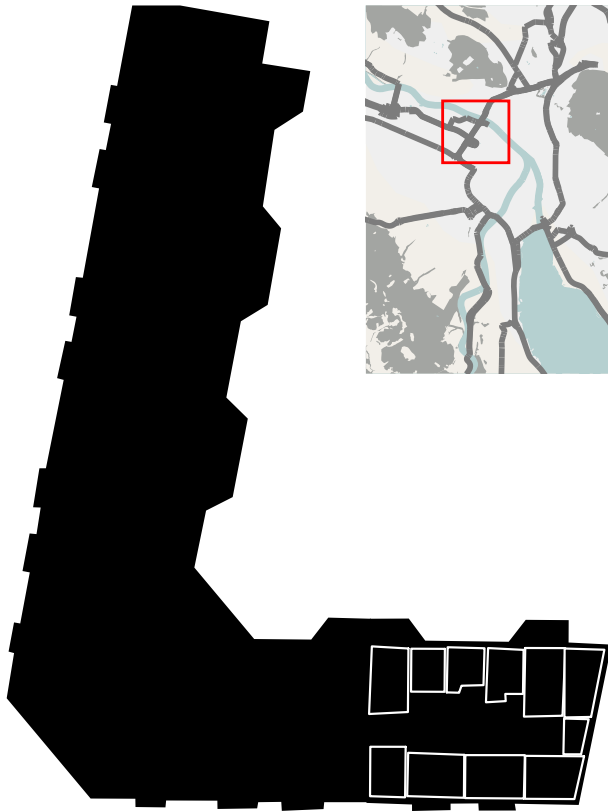

Map of Zurich indicating the object's location, schematic expands of the Building complex and the floor plan of the investigated south eastern wing.

Result

The solar access analysis was carried out for the locations of Zurich (Mid Europe), Aberdeen (northern Scotland) and Cagliari (southern Italy). For each site I compare the before (left hand) versus after (right hand) situation. The window size of the before-situation corresponds to the initially planned dimensions, whereas the window size of the after-situation corresponds to the window dimensions which are adapted according to the calculated f factor. The total radiation entering the room is depicted as colour coding. The total radiation is calculated from the incident radiation, the window area, the g value and the fc value of the sunshade.

Zurich

For the location of Zurich the weather data of Munich was used. Munich has a similar climate being city bordering the Alps to the north and solar radiation patterns do not change such local scales. In the initial state the windows of southwest facing facade have highest solar gains. These are also the windows, which needed to be scaled down to meet the required 7 W/m^2 . The smaller windows on the back facade could be slightly enlarged. Since the corner rooms have two windows the solar gains in these rooms are higher. This is also reflected in solar gains of the northeast facade. Even though all the windows have initially the same size, the corner windows need to be reduced in size to meet the target of area specific solar gains in the rooms. The window dimensions have to be reduced in average by 10 % and the total solar gains amount to 7800 Wh/h .

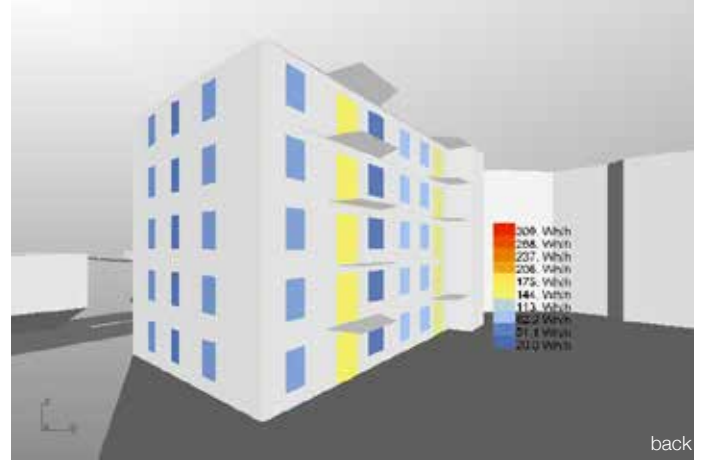
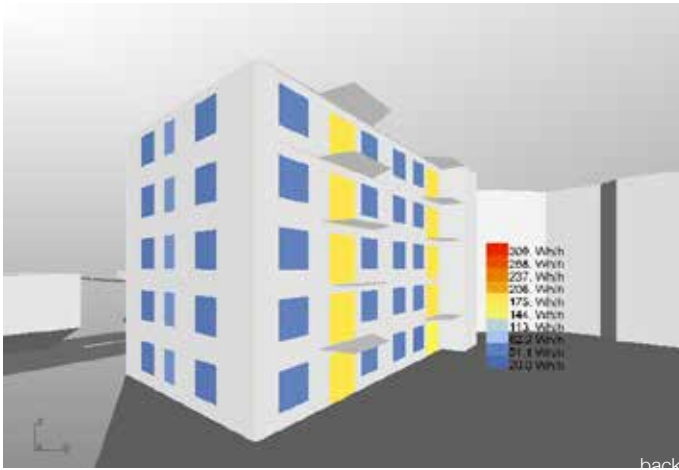
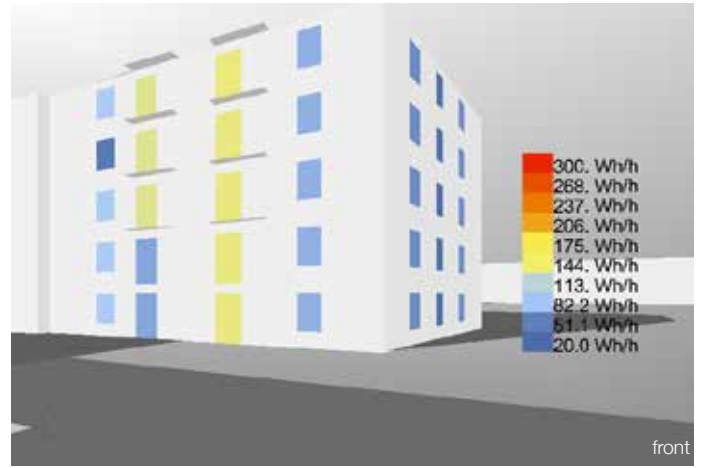

Window dimensions and total radiation entering the windows of the initial Situation for Zurich.

Window dimensions and total radiation entering the windows of the adapted Situation for Zurich.

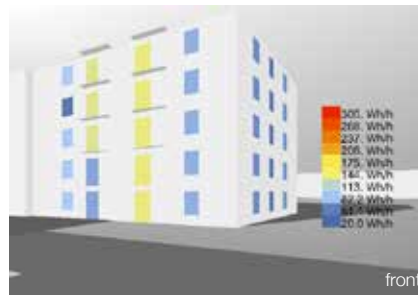
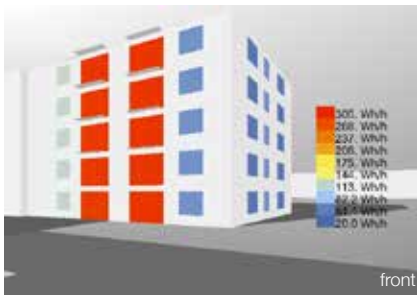

Window dimensions and total radiation entering the windows of the initial Situation for southern Italy.

Window dimensions and total radiation entering the windows of the adapted Situation for southern Italy.

Southern Italy

If the object would have been set in southern Italy the pattern that can be observed matches very closely the one from Zurich, even though it is far more pronounced. The large windows on the southwestern facade need to be reduced by 50 % in size, where as at the location of Zurich only 65 % reduction in size was needed. Also the corner windows need to be significantly adapted. The average reduction factor for southern Italy is 0.7 and the total solar gains of the whole building part account to approximately 8900 Wh/h.

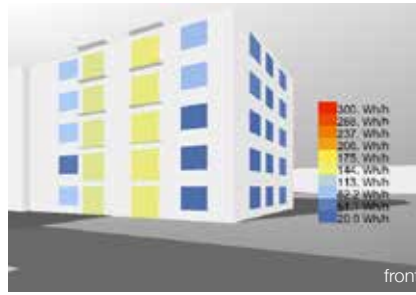
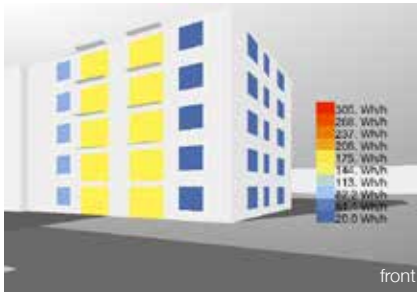

Northern Scotland

If the same building is placed in northern Scotland the picture drawn is very different from the one of Zurich and southern Italy. In fact here the average window dimensions do not have to be reduced, but can be enlarged on average by a factor of 10 %. However looking at this in more detail, the windows on the north east facade can be enlarged significantly, but the large windows facing southwest need to be reduced in size by 80%. The total solar gains are 5600 Wh/h.

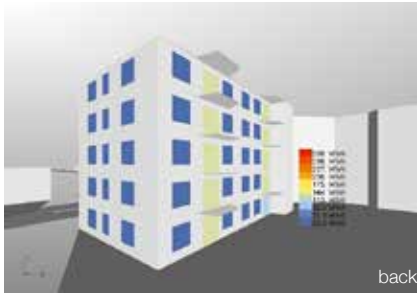

Window dimensions and total radiation entering the windows of the initial Situation for northern Scotland.

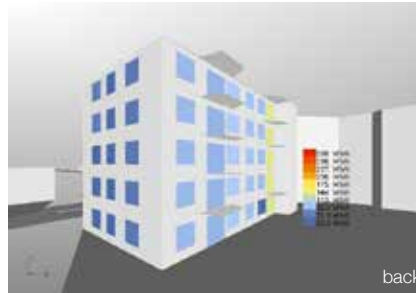

Window dimensions and total radiation entering the windows of the adapted Situation for northern Scotland.

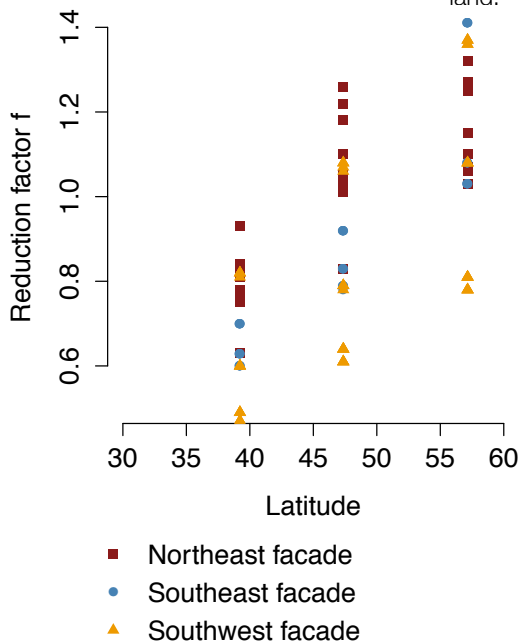

Calculated reduction factors compared to latitude of the specific location.

Correlation with Latitude

In order to compare the above shown examples. The reduction factor can be plotted against latitude. The different colours correspond to the three different oriented facades.

There is no clear correlation since the varying window and room size is offsetting the clear relationship of total radiation with latitude for the three different orientations. However, the lowest values are found for the southwest facing facade, whereas the factors of the northeast facade tend to be at the upper limit and the ones of the southeast facade mostly in between.

Conclusion

The analysis demonstrates that the amount of solar gains is very strongly linked to the window dimensions. As a Result from the analysis one can rapidly determine the individual and optimal size of the windows for each room. These

dimensions need to be understood more as guidelines than as a compulsory requirements. Firstly, because it is not economically feasible to assign individual sizes to all the different windows. Secondly, if the focus of the building lays on the user comfort regarding daylight and an unconfined view to the outside and not on the energetic performance then this analysis is unhelpful. At last, if the air conditioning of the room is obtained by means of an energy and exergy efficient cooling system the facade is in some cases even designed to maximize the solar gains. The regenerating of a thermal earth storage with free cooling through the floor heat exchanger is an example for such a system. However, if the emphasis lays on the energetic behaviour especially to reduce overheating in the summer, then this analysis might be helpful the gain a first indication, what the dimensions of the windows for each facade could be and what the average window fraction of the building could be. It is then depending on the cooling system and the aimed energetic performance, how far the results of such an analysis should be taken into consideration.

Khayelitsha Re-Clustering

Student: Andrea Gonzales Palos



To analyze an urban element, there are different factors that play a role in its interpretations. Apart from the rough data, there are economical, social, physical, environmental, etc. elements that can affect the way a person perceives their environment.

For the following analysis, only the physical aspects of a defined urban space are taken into consideration to evaluate and eventually propose, with different parameters, a new urban arrangement. Factors such as the visibility range in each space, the different routes by which people can move along the settlement because of the way the volumes are placed or the areas that are more likely to be used in the area, are all analyzed through digital methods. These analyses provide information that allows urban planners to then subjectively evaluate the quality of the existent or designed space. Although these types of analysis can sometimes become too objective, and be missing some interpretation to really make them useful, they are a great tool to understand in a simple way the very complex properties that space has. The BT Section in Khayelitsha, South Africa, is an informal settlement that grew without any plan or consideration for space. It is interesting to see how, due to necessity, people arranged their living space in the best way they could, eventually defining an urban area. With the use of a digital urban analysis, we can understand how these initial configurations of small houses created a complex urban system, with main paths, crowded spaces and different private and public areas. The Khayelitsha Re-Clustering project was done with the aid of digital tools such as Grasshopper and Depthmap in order to help the urban planner take into consideration certain parameters for the re-clustering of the area. The main goal was to maintain some of the current urban conditions: main avenues, areas with potential for public spaces, shack sizes and proximity, but also to provide a different arrangement option that would improve the space and boost its current qualities. For the footprint of the shacks, Grasshopper was used to analyze the current sizes and then replace them for established proposed typologies. Then, after doing the path and isovist analysis with Depthmap, the main spaces were located, the new typologies automatically rotated and moved around them. This same process could be repeated in any other urban settlement, establishing the desired housing typologies (sizes, geometry) and then locating streets and “cluster” areas that arrange the new typologies.

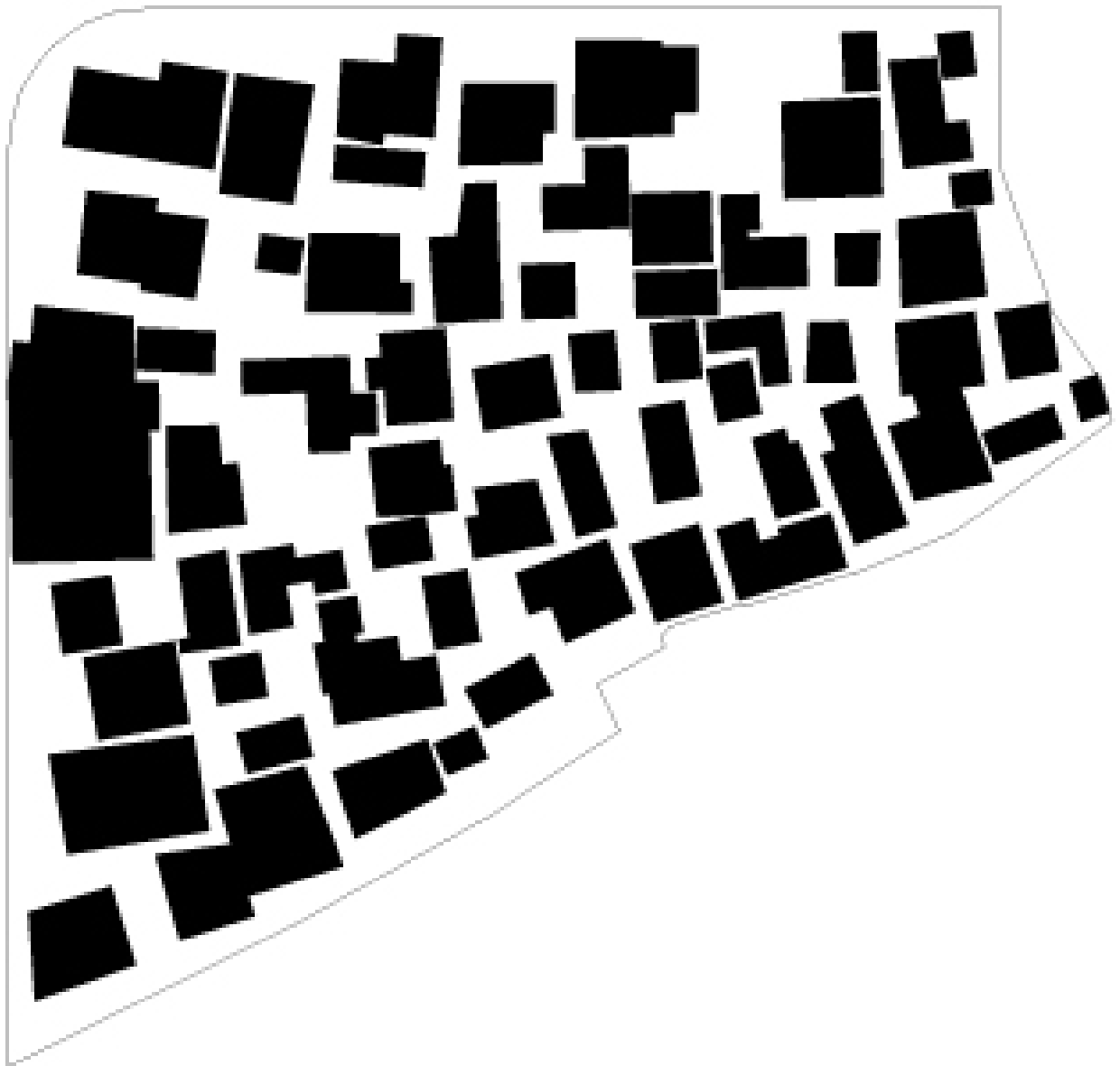

Analysis 1 (Connectivity):

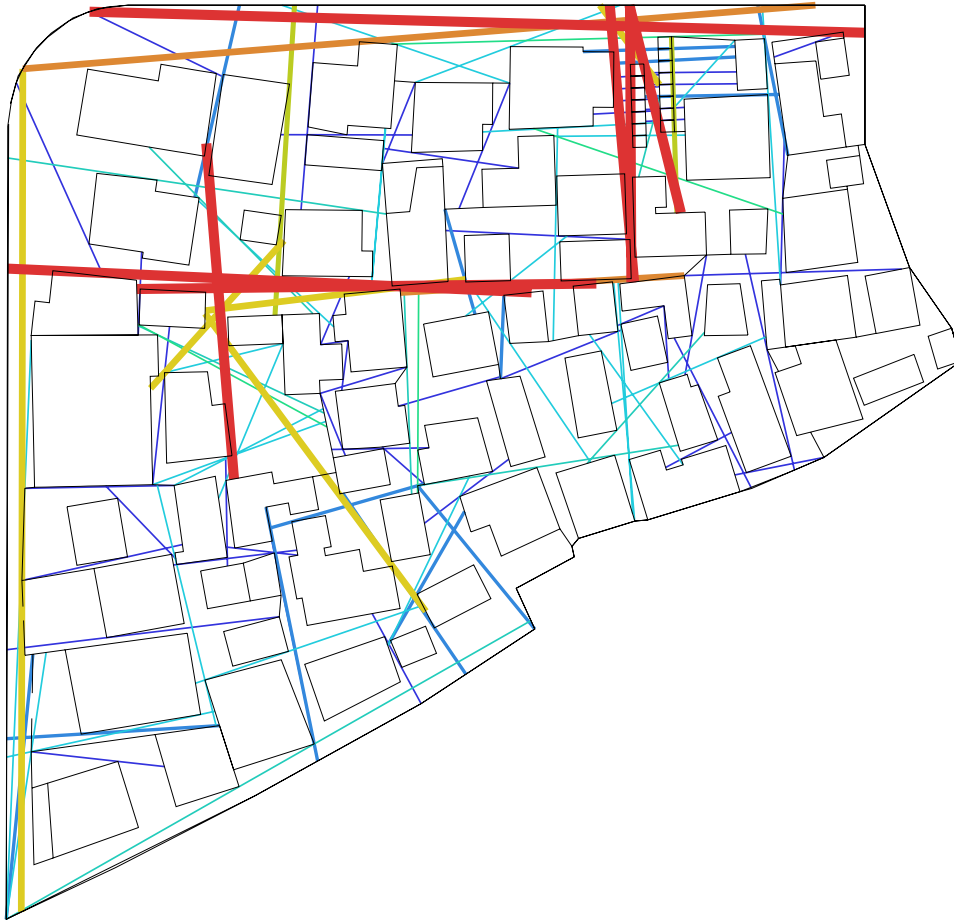

Analysis 2 (Isovist Area):



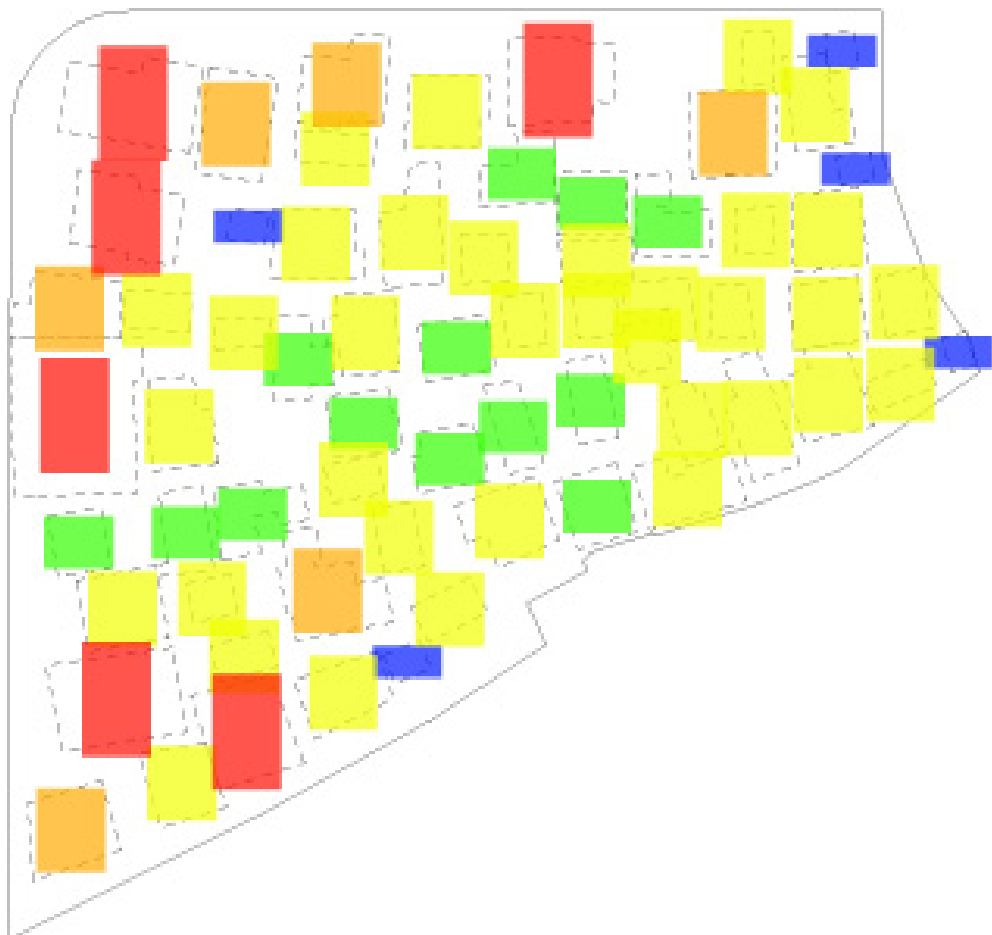
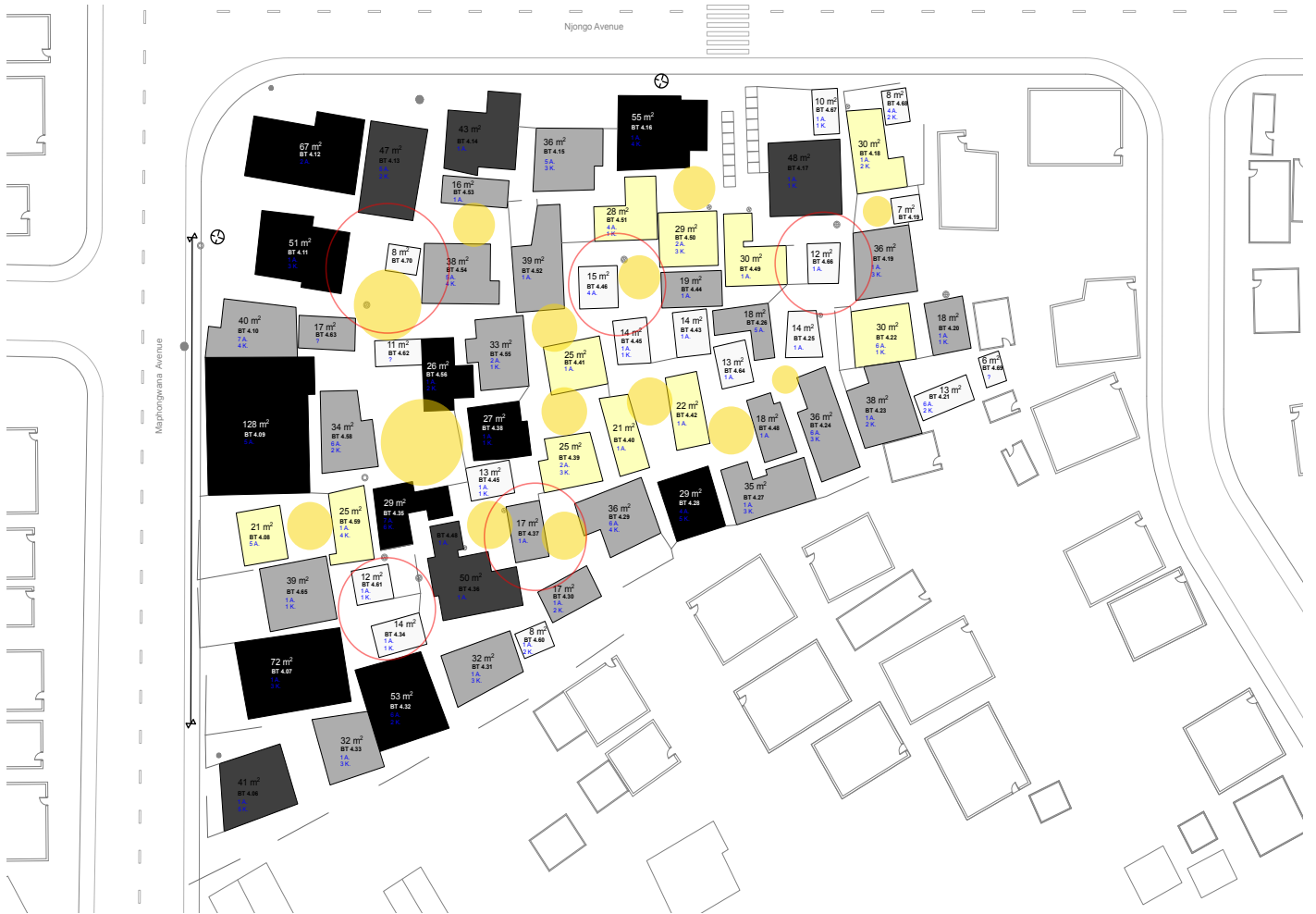

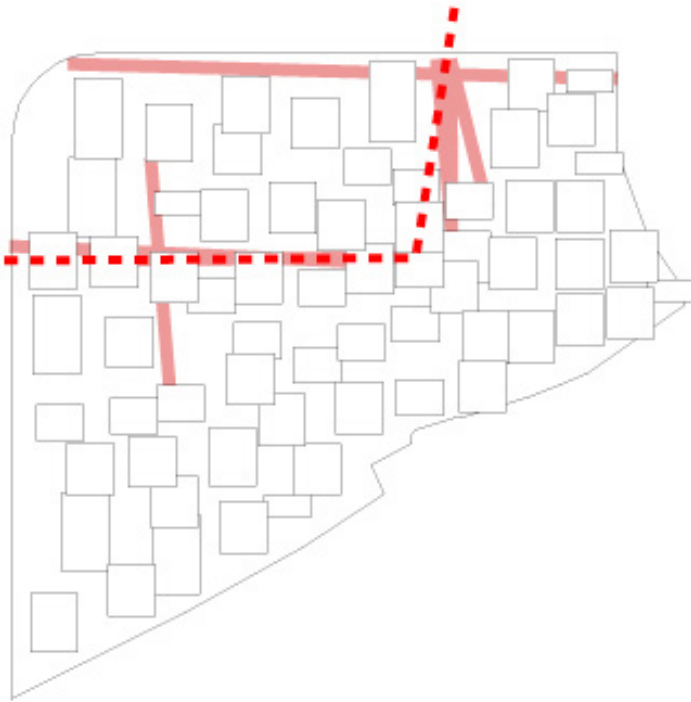

Street Proposal based on Connectivity Analysis

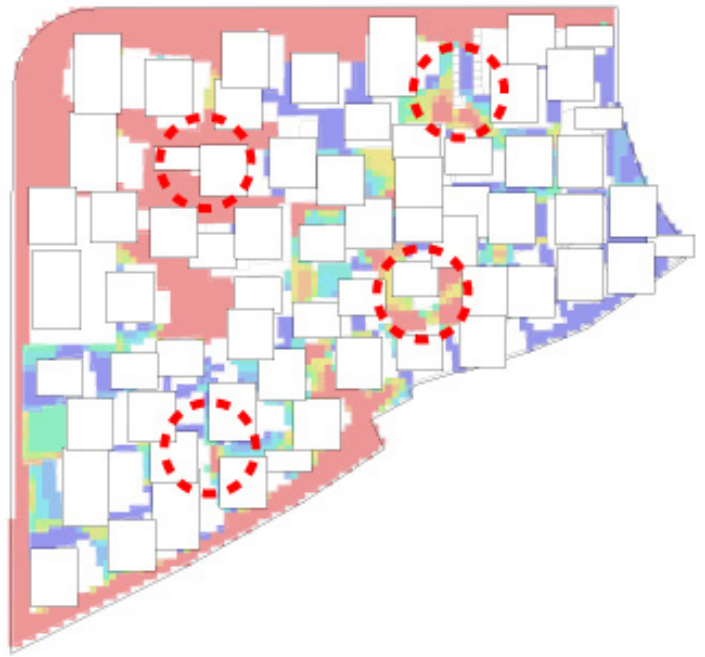

Courtyard Proposal Based on Isovist Area Analysis

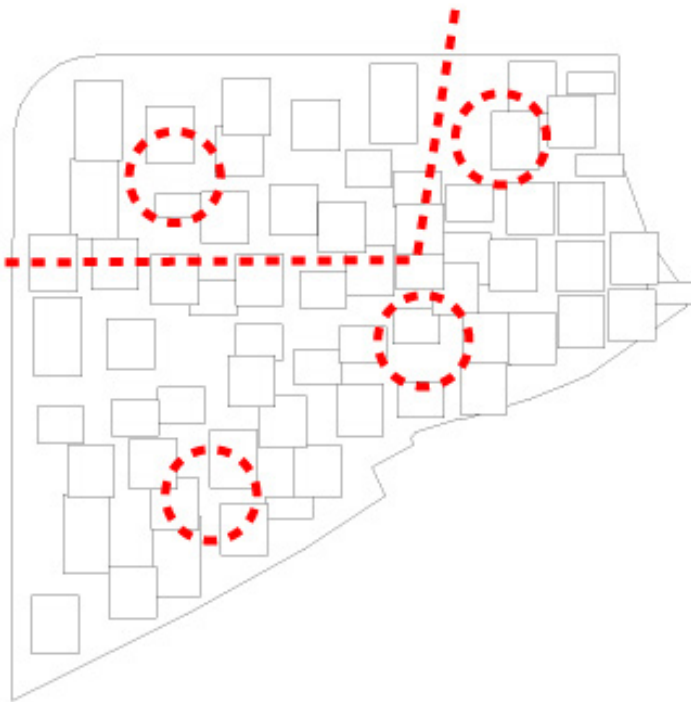

Street and Courtyard Proposal

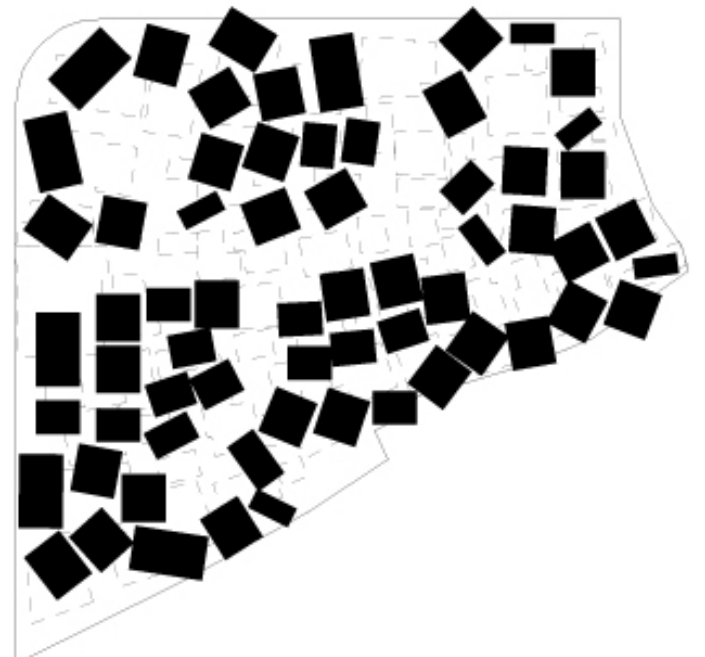

Re-Clustering

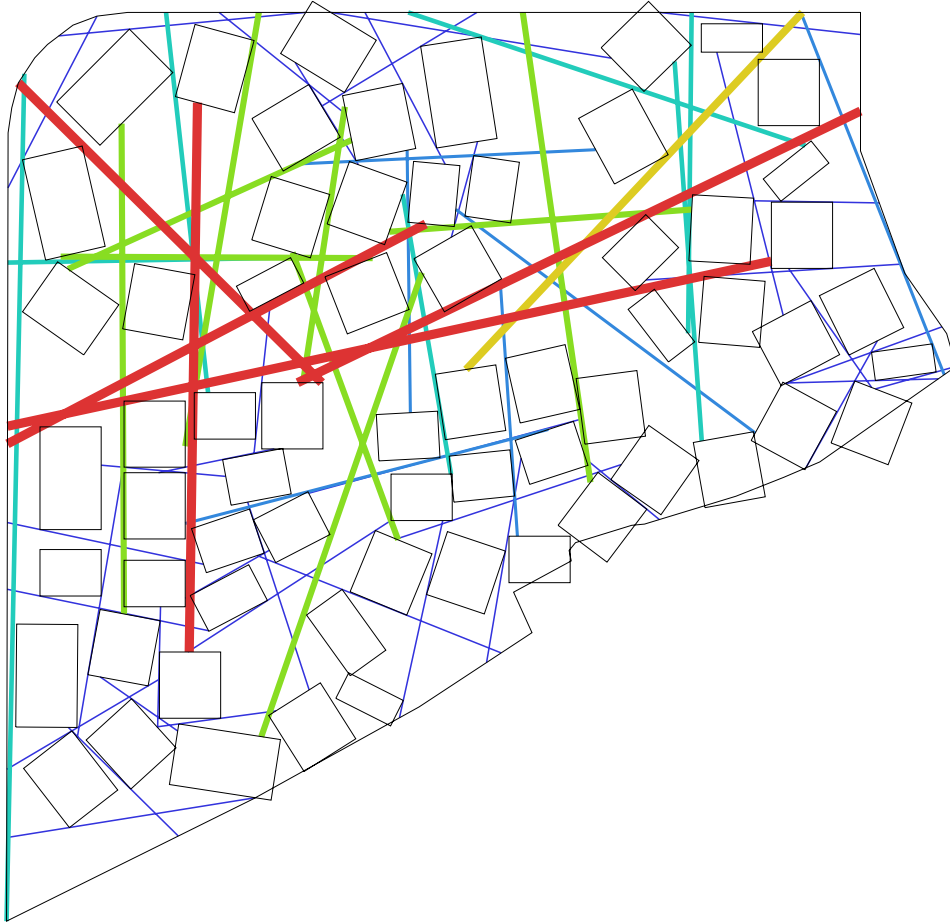

Analysis 3 (Connectivity)

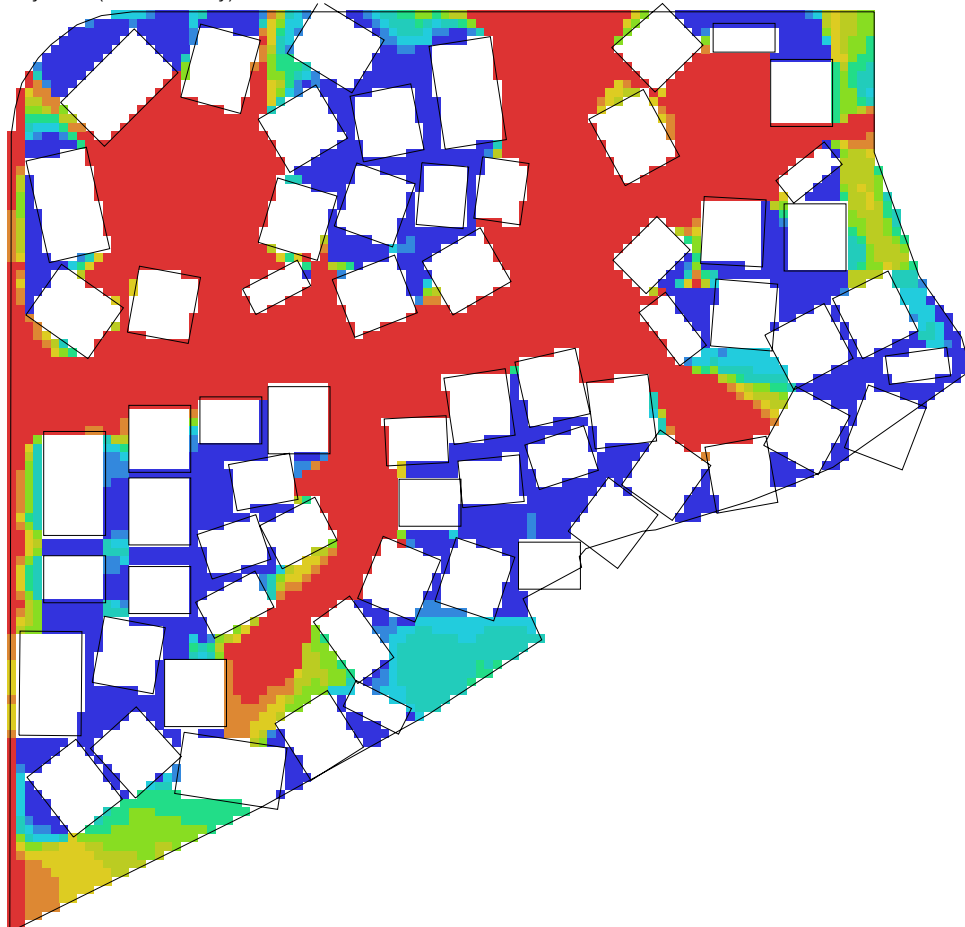

Analysis 4 (Connectivity Area)

Conclusions:

By using the different methods of analysis provided during the course, I could first analyze and localize important aspects of the original urban plan of Khayelitsha, and then use them as a guide for an automatically created urban plan.

In the plan created by Grasshopper, it can be seen that the organization of the main pathways is clearer. Instead of having paths that went along the edges of the project or didn't really connect the different spaces, in the second proposal there is a clear difference between circulation space and built space and the main street are always connected to each other. Looking at the Isovist area analysis, the original layout of BT Section created a very irregular gradation from public to private space. The areas to the left of the site are a lot less dense than the right side and this created different visual qualities of space throughout the site. In the Digital Re-Clustering, the change of footprint for shacks and the rearrangement around courtyards created a different quality of space. Further analysis and design is obviously necessary, as the geometry is not the only thing that defines an urban area, but this digitally created proposal can definitely be used as a base for an urban design that has certain initially defined goals.

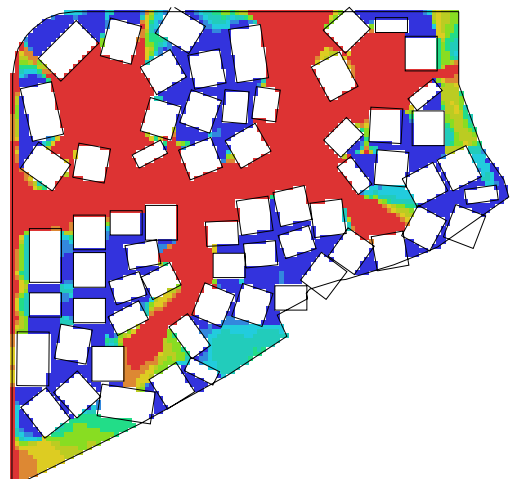
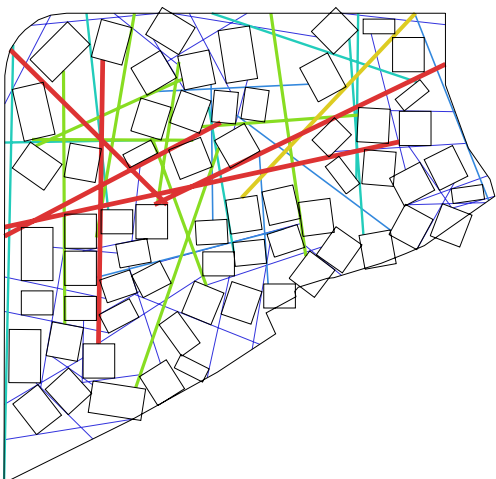

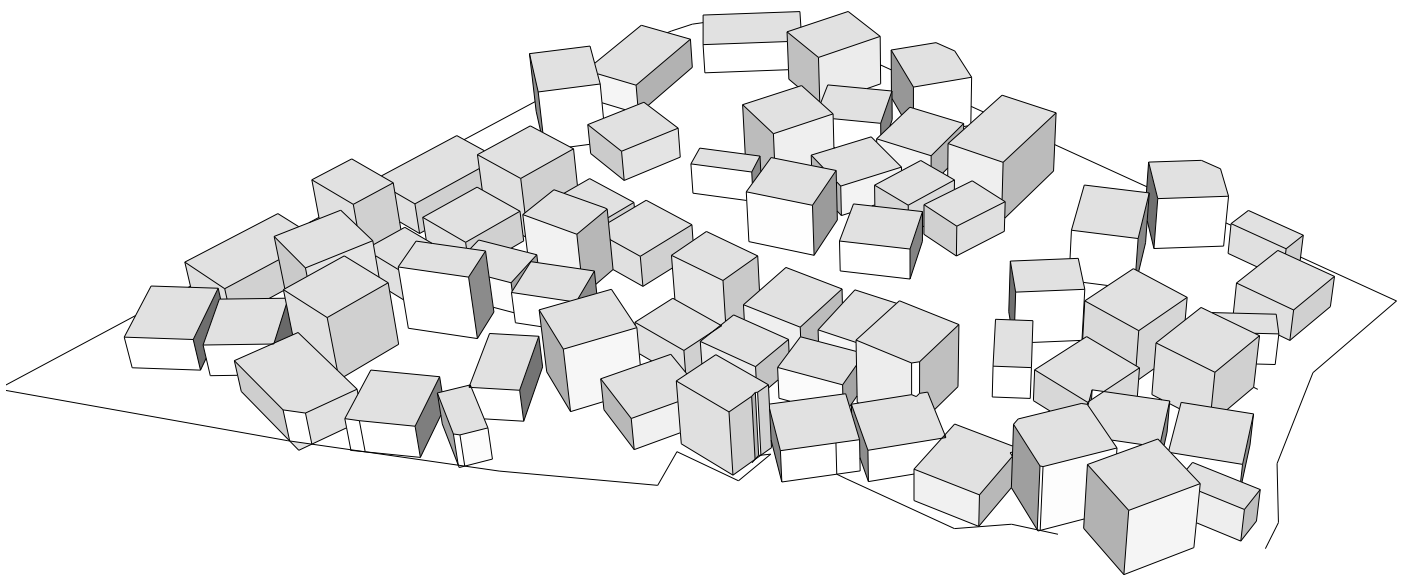
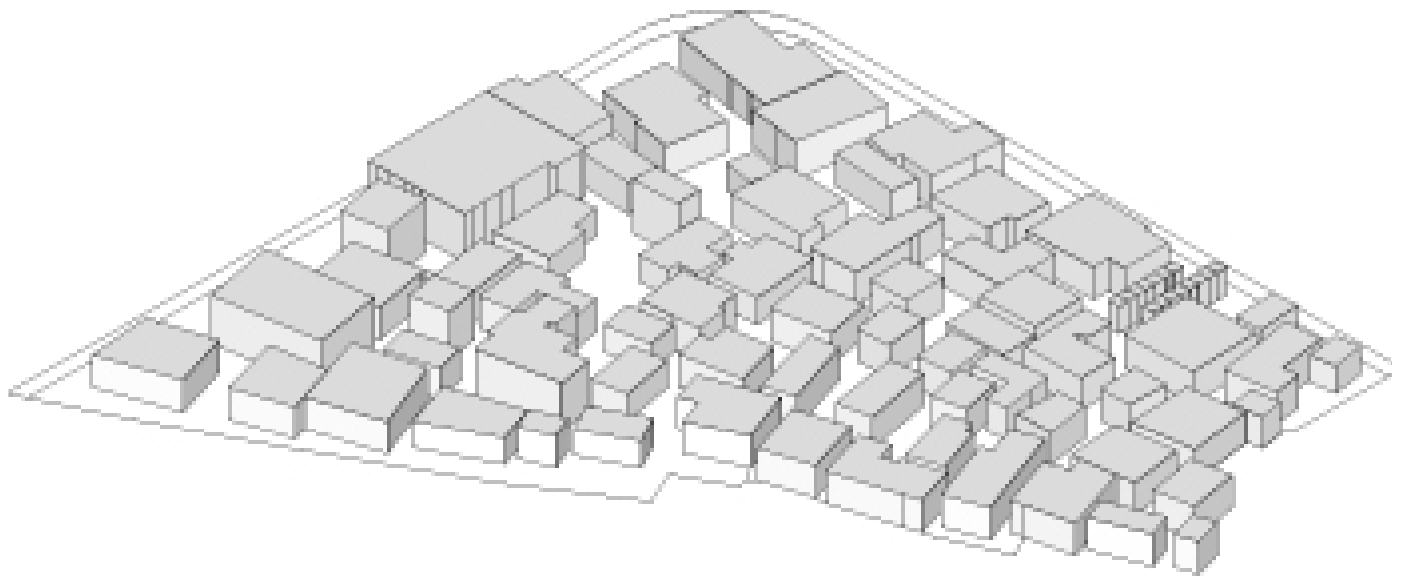

Urban Planning in Milan/Cimiano

Student: Benjamin Gurtner

1. Motivation:

This new part of the city of Milan is between the Parco Lambro and the city. It has to better define the limit between building zone and green zone and also to make a better junction between parc and city. The goal is to make a global analyse about this urban planning project. The idea is to use different tools to make a global analyse about different points.

The axial map has to define where are the more important streets and to see if the organisation is really good or not. The isovist map has to say if the ways (or the openings) from the city to the parc are good. The shados analyse has to say if the new part of the city has enough lightning and if it dont disturb the rest of the city and the parc. Finally, the solar access analyse has to say if the building have enough/to much/to less solar radiation.



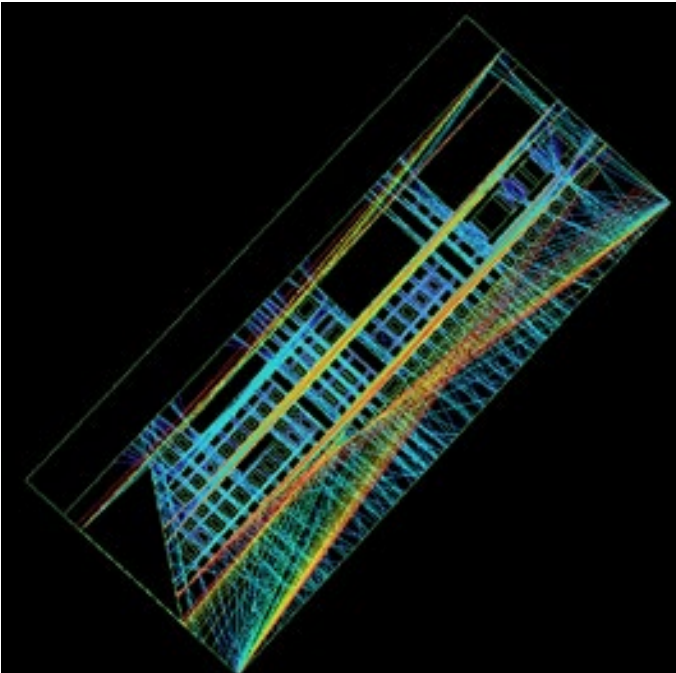

1. Axial map (Line length)

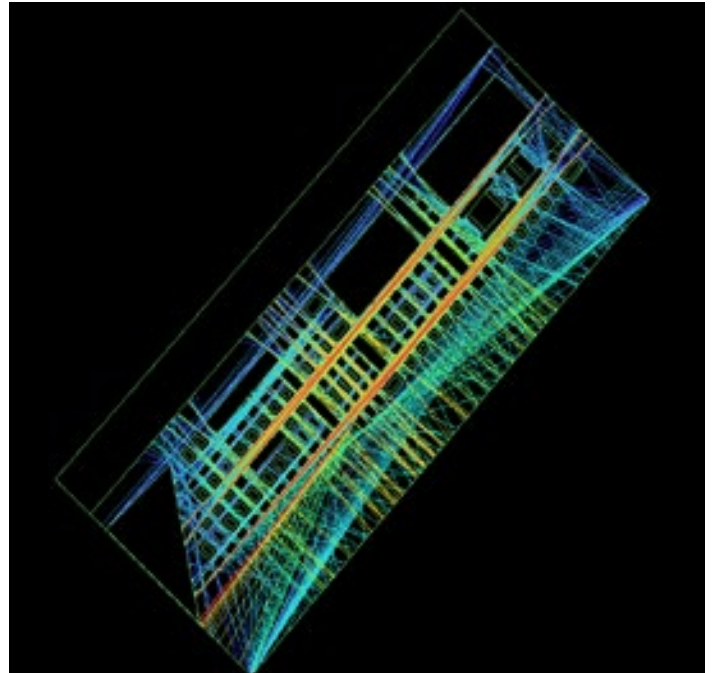

2. Axial map (Connectivity)

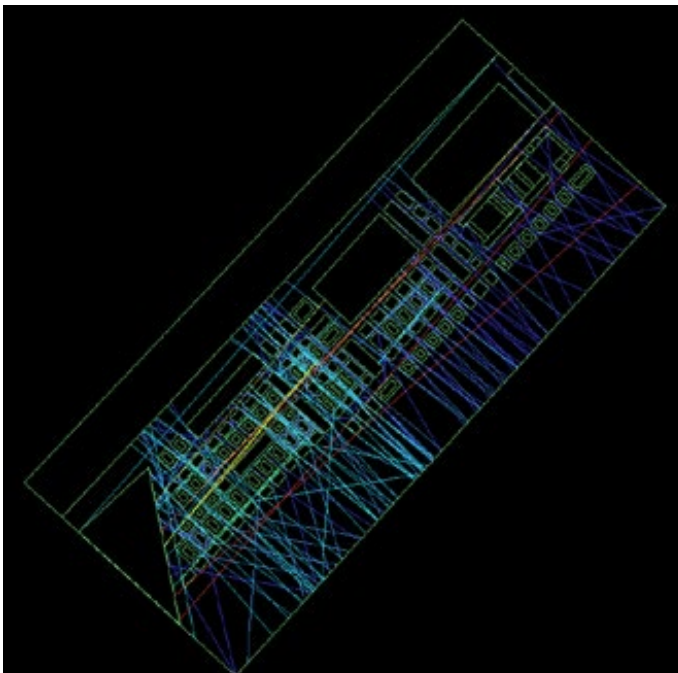

3. Axial map (important lines)

We can see that the most important streets are along the big street. Its a good point for the traffic because this long streets have to take the most important part of the traffic. They are also the most largest street in the planning.

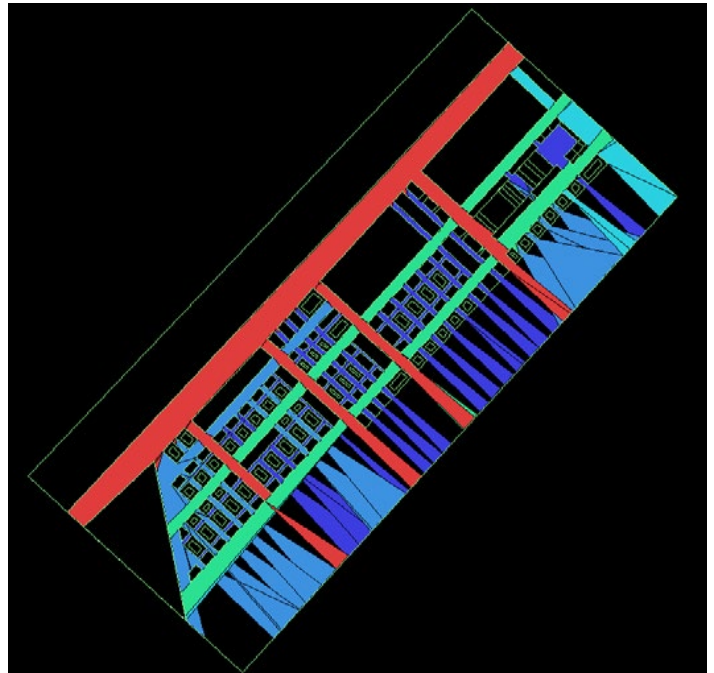

4. Isovist map

We can see here that the visual and spatial connection is good define. The red forms are along the street who have to be use for the traffic. The connection from the big street to the parc is good. This urban zone is like an open border who let a visual appeal from the green zone to the big street (city).

Analysis 3 (Shadows analyse):

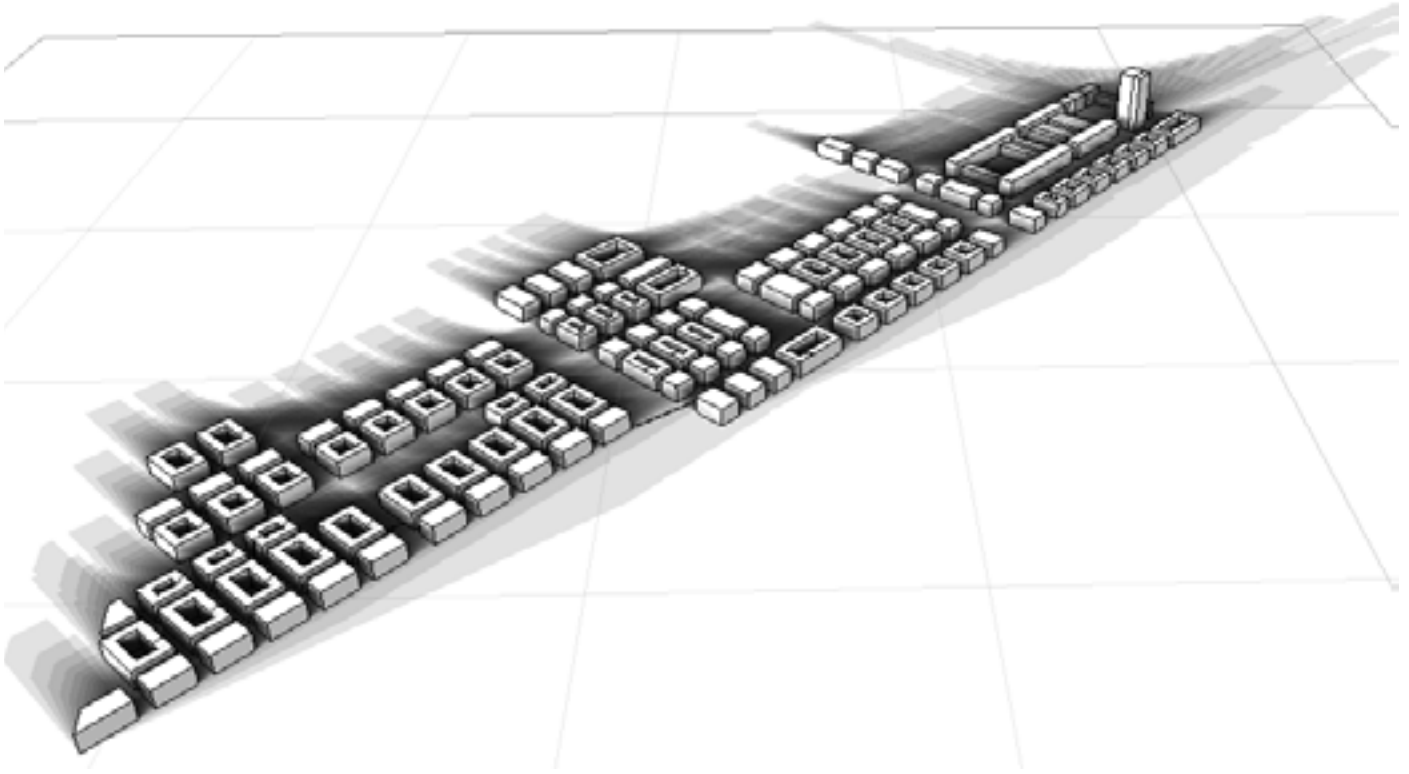

5. Winter solstice (12/21)

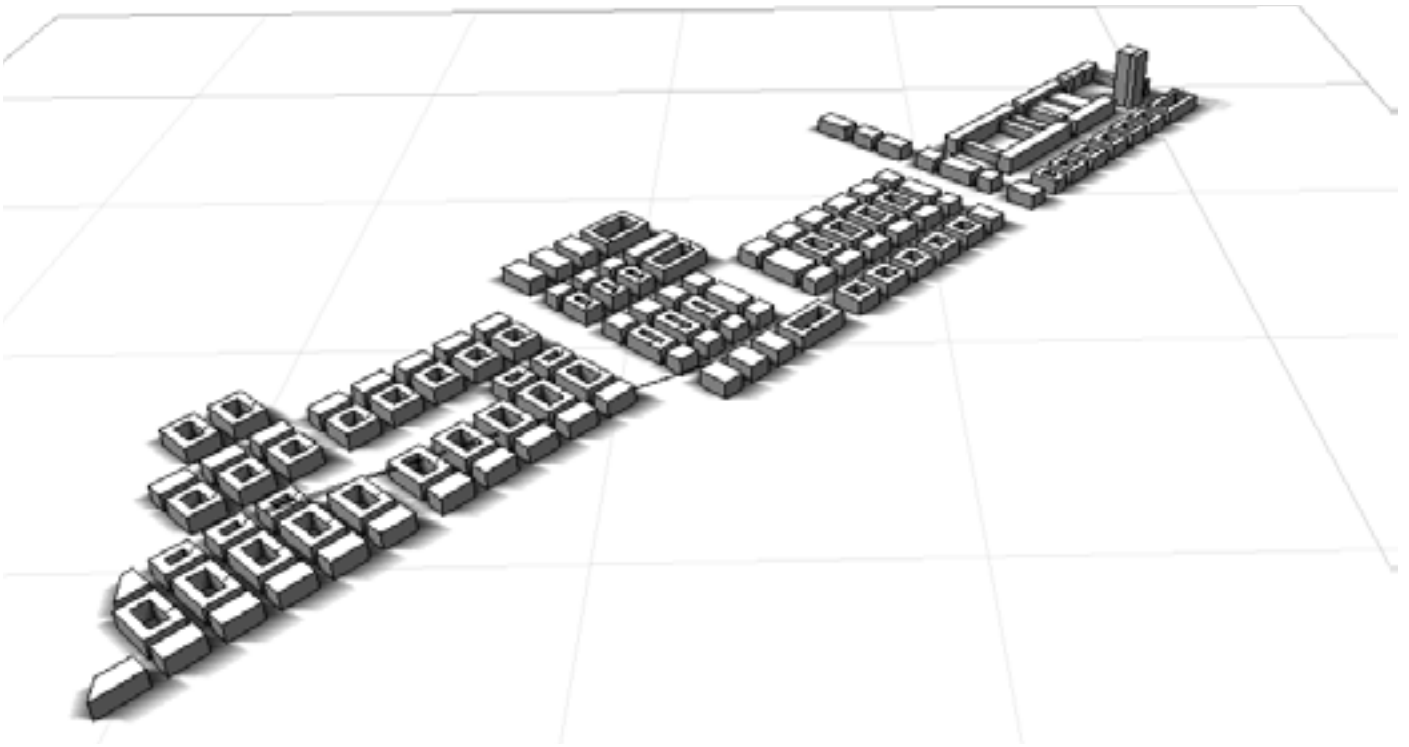

5. Winter solstice (12/21)

The low rise of the buildings dont disturb the rest of the city and the parc. The free places in the new building zone are also usefull for the lightning inside this urban zone.

Analysis 4 (Solar access analyse):

We can see here that the solar radiation is not too hard. The low rise of the buildings and the different free places make a good deal between shadows and sunlight. The orientation south/west to north/east is also not bad and a quiet place to work in summer and winter. The tower in the north/east has also not too much sunlight because of her orientation. Of course we can see that the situation in the little streets is different. These streets are not so large and the buildings from a side make shadows in the buildings from the other side of the street. This problem is actually not so hard because the buildings are not high and we think that there is enough light also in the little streets.

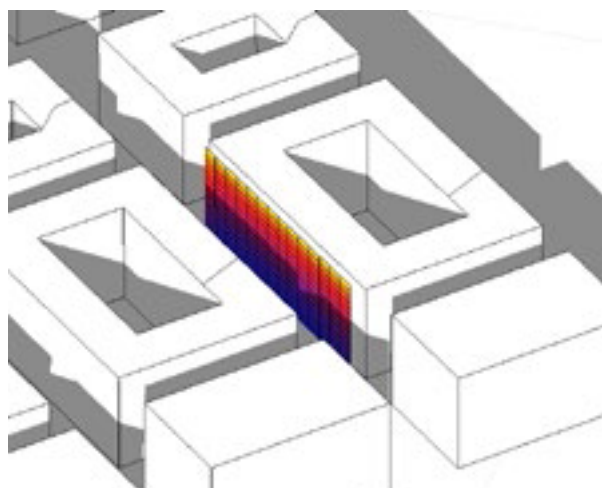
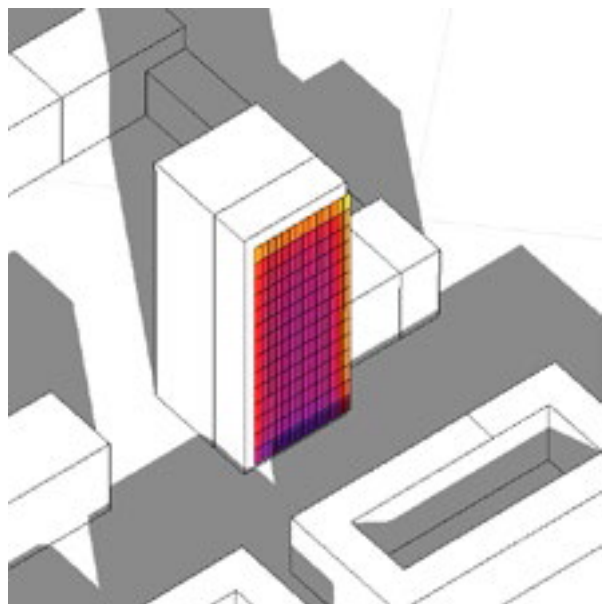
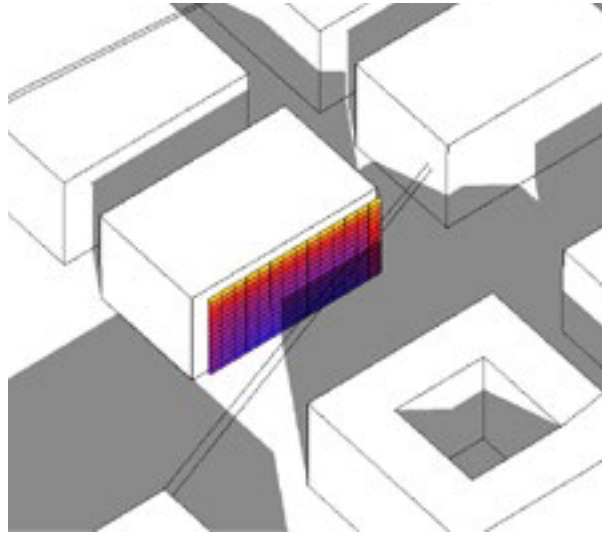

8.-9.-10. Solar radiation in façade

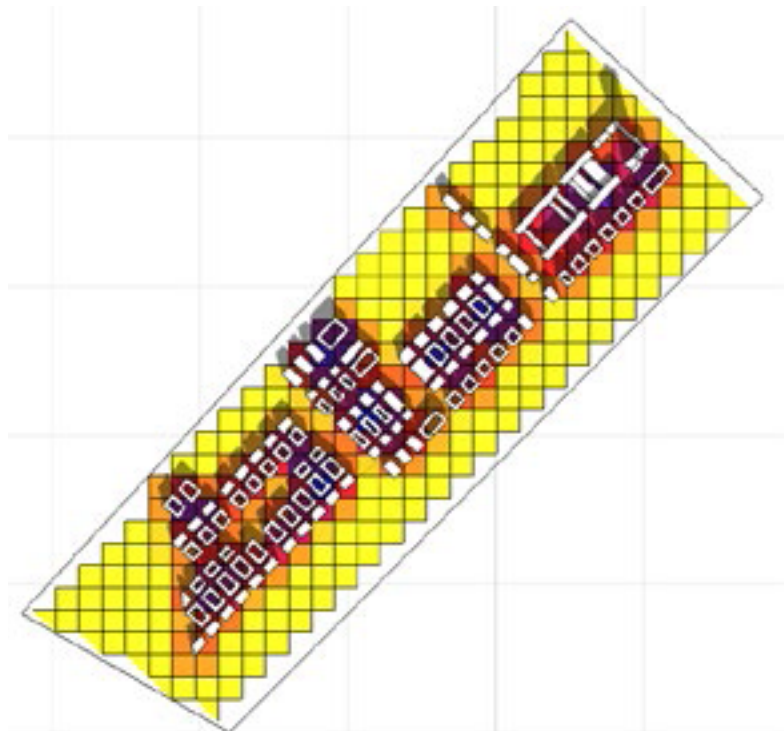

7. Solar radiation plan

3. Conclusions:

After this global analyse, we can say that this new urban zone answers good to the different questions:

-The traffic is good managed (with the two big streets along this zone).

-The connections to the park are also good managed. The visual connection to the park is good and there are a lot of different ways to go there. This connection is also good in the point of view of the traffic because we see that the most important perpendicular streets are exactly where the streets for traffic is planned.

- The question of the solar radiation and the shadow is also good resolved in this urban zone with the different openings (free zones) between buildings and the low rise of this part of the city. In conclusion, we can say that we are happy from the result of this global analyse which confirms our choice for this new urban zone in terms of connection with the park, management of the traffic and solar radiation. We can say positively that this new plan has not factual big problems.

Rosengartentram & Rosengartentunnel

Student: Bettina Dobler



Summary:

In 1973 the four-lane Rosengartenstrasse was built as a provisional element of the Westtangente. Since then the Rosengartenstrasse cuts through the district Wipkingen/ Rosengarten and makes any further urban development impossible for this area. Today 56000 cars drive along the Rosengartenstrasse every day. Because there is a lot of traffic on this road, the bus lines from Albisriederplatz to Buecheggplatz are always overstrained. Also the adjacent residential districts suffer from the traffic jam, the air pollution, traffic noise and from the Rosengartenstrasse as a danger zone for children. The City and the Canton worked out a plan to solve the infrastructural problems. They want to build a new tram line from Albisriederplatz to Milchbuck to improve the public transportation network of Zurich. They also want to build a tunnel from the Wipkingerplatz to the Buecheggplatz and to the Milchbuck for a better traffic flow through the city.

In 2024 they start with the construction of the Rosengartentram & Rosengartentunnel. The expected opening of the Rosengartentunnel should happen in 2030 and after two years the new tram line will be realised. The projects cost 860 mio. CHF. The parties involved are TAZ, VBZ, DAV, AfS, UZG and the Canton of Zurich. This two projects will also have many effects on the residential districts Wipkingen/ Rosengarten. After the interventions it will be more attractive to live there, because of the good connections and the noise reduction.

Motivation:

I live near Wipkingen and I often have to use the Rosengartenstrasse by bus. Sometimes it is really exhausting, because if I have to use the Rosengartenstrasse by bus, they are always late. I recognize the problems of the Rosengartenstrasse and that is why I want to prove the proposed infrastructural projects. I am interested in what are the effects of the Rosengartentram & Rosengartentunnel on the neighbourhoods and how the importance of the Rosengartenstrasse changes, but first I want to understand the current situation of the Rosengartenstrasse. I also would like to know which areas would be activated by such an intervention and where the new sites of potentials in terms of further development are. I think the angular segment map analysis could provide a better understanding of the complex situation. So I would like to analyse this current situation and want to have a look at the situation before and after the planned projects.

Rosengartenstrasse today: traffic flow at 11 am



Rosengartenstrasse today: traffic jam at 18 pm

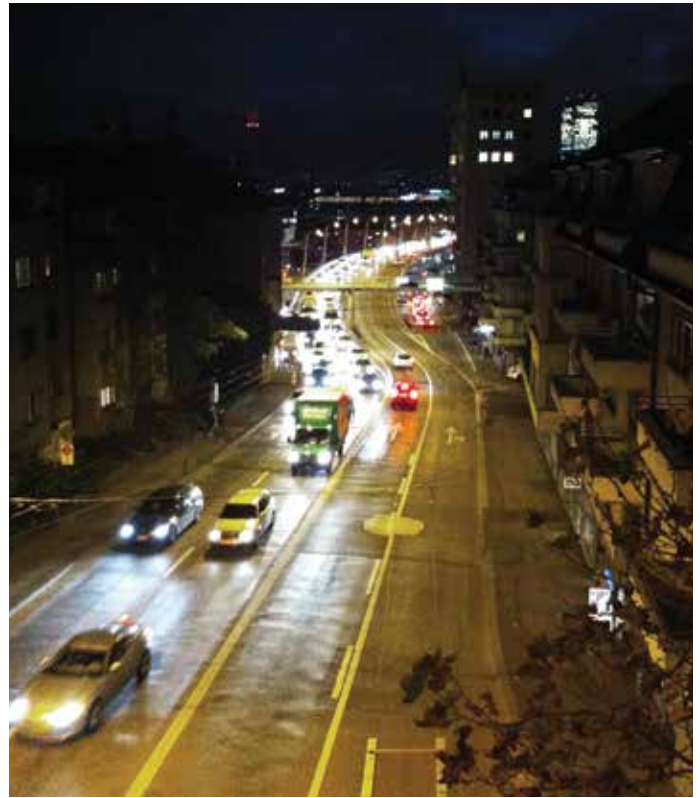

Plannings of the City and the Canton Zurich:



- Tunnel in Planung
- ⤵ Tunnel-Ein-/Ausfahrt



- Tramlinie in Planung
- ⋯ Realisiert bis 2014
- Umsteigehaltstellen
- Haltstellen

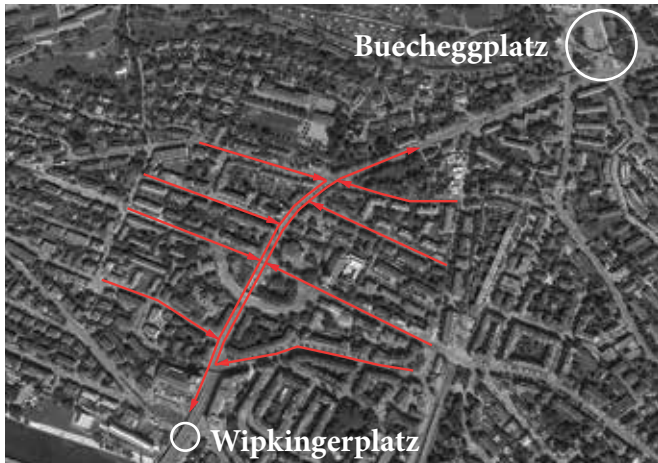

Current situation at the Rosengartenstrasse:
The Rosengartenstrasse cuts through the neighbourhood.
Because there is no connection from one side of the street to the other side of the street, I had to double the line for Rosengartenstrasse and separated them to create the right segments for the analysis with Depthmap.

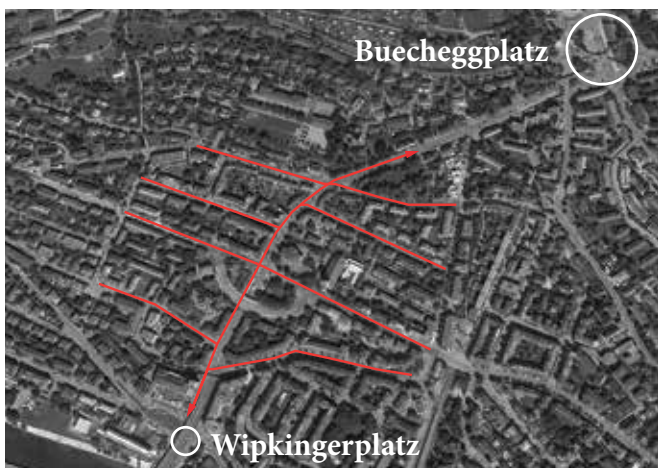

Two-lane Rosengartenstrasse:
The new traffic management guarantees a constant network of the districts. For this case I could draw the lines like to run the analysis.
Because this tool is not able to recognize different layers I splitted up the analysis into two (one which shows the situation above the tunnel and one which shows the situation by using the tunnel) .

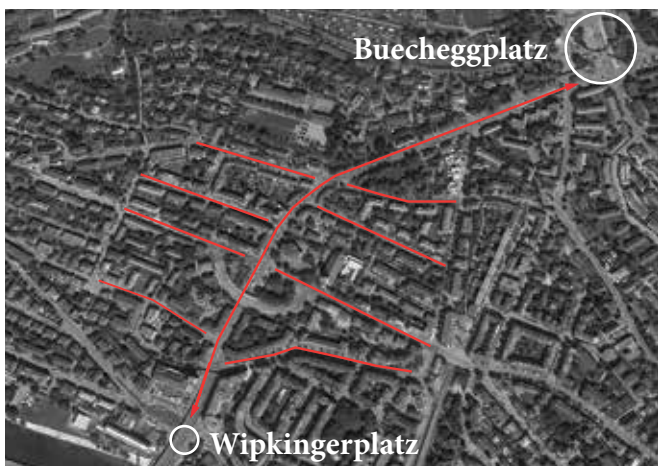

Rosengartentunnel:
With this drawing I tried to run the analysis by using the tunnel, but the Rosengartentunnel exonerate the Rosengartenstrasse above which you can not show in Depthmap, because this tool does not recognize different layers.

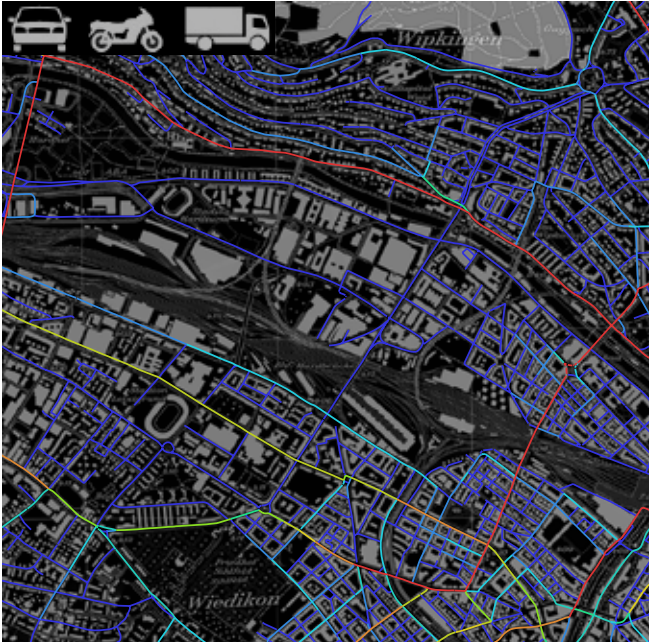

Analysis 1

Space syntax analysis/ angular segment analysis/ include weighted measures/ angular connectivity/ no radius/ choice: Current situation at the Rosengartenstrasse

I took the streetdata from open street map. Then I worked with Q- GIS and produced a map with all driveable roads by creating filters (type is not food-path, type is not hiking trail, type is not....). After that I cleaned it up in Rhinoceros. Then I imported the the cleaned dxf to Depthmap and runned the analysis of the whole city for 2 hours.

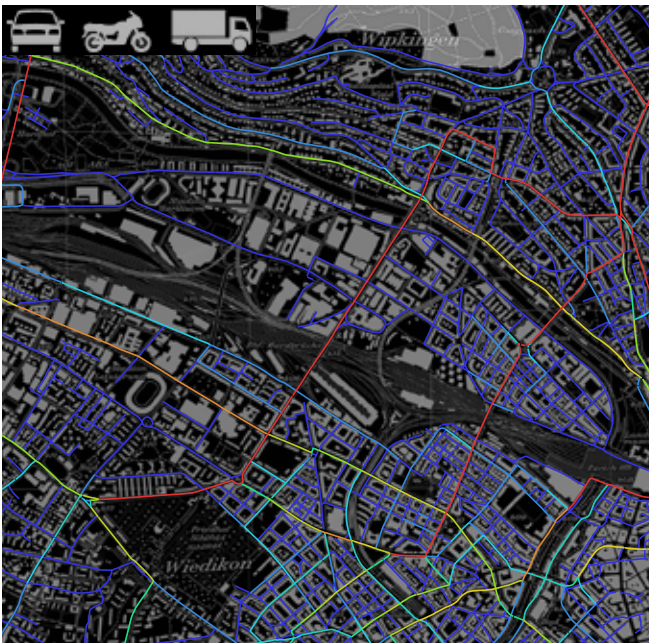

Analysis 2

Space syntax analysis/ angular segment analysis/ include weighted measures/ angular connectivity/ no radius/ choice: Rosengartentunnel

To analyse the Rosengartentunnel I had to run two separate analyses. I splitted it into one analysis which should show the situation above the new tunnel and into another analysis which should show the condition by using the tunnel. Below you can see the analysis of the situation above the tunnel. You see that the axis Hardbrücke- Buecheggplatz becomes more important and some roads are light- blue in this area, because now they are better connected to each other.

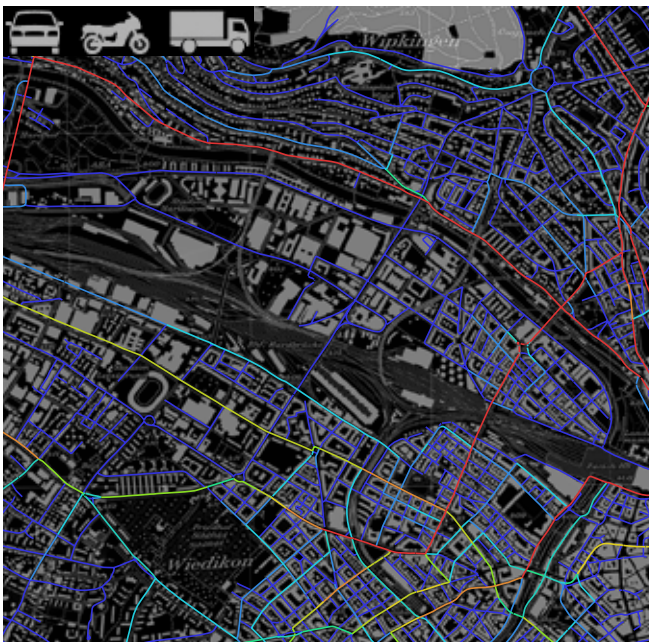

Analysis 3

Space syntax analysis/ angular segment analysis/ include weighted measures/ angular connectivity/ no radius/ choice: Rosengartentunnel

Here you can see the analysis by using the tunnel. The result is a bit unconvincing, because you can not see the importance of the Rosengartenstrasse and how the tunnel exonerates it. Maybe the chosen sector was too small, but to run three times a analysis of the whole Canton it would calculate a long time.

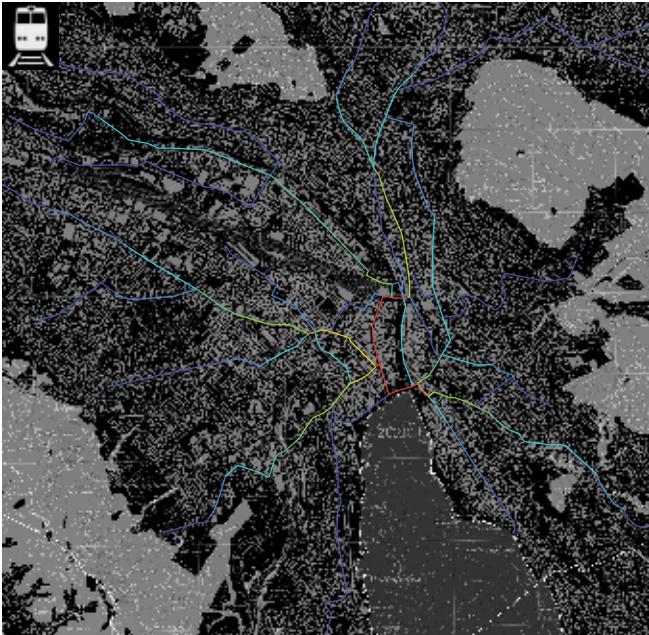

Analysis 4

Space syntax analysis/ angular segment analysis/ no radius/ choice: Current tram network of Zurich
 First I draw the whole tram network of Zurich in Rhinoceros. After that I imported the dxf file in Depthmap and runned the analysis. What we see through this analysis is that at the moment the tram network is not well connected in the outer regions of Zurich. The lines are blue there. The line in red is at the moment the most important tram axis. It is the line from the Central through the Bahnhofstrasse to the Bellevue.

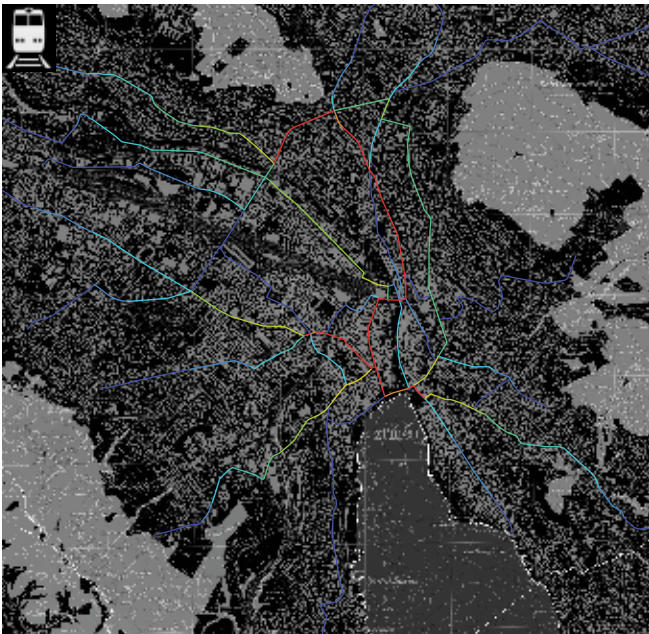

Analysis 5

Space syntax analysis/ angular segment analysis/ no radius/ choice: Network with Rosengartentram line
 The Rosengartentram line connects the northern part with the western part of the tram network of Zurich.
 In the analysis you see very well the importance of this linke. This new tram line activates these two parts very much.

Conclusions:

The angular segment analysis is a good tool for analysing street networks, because it reflects the real street organisation and how someone decide to use which street. It is a good tool to get a better understanding of complex networks. By analysing the smaller and closed tram network it worked very well.

To test the Rosengartentunnel I had some problems which I could not solve. For example this tool is not able to recognize different layers and can not calculate the exoneration of a district from a tunnel. An other problem is, that this tool cannot notice different hierarchies of different roads, that is why some lines became red, although this roads in reality are less important , because it is for example a 30 km/h zone and that is why you would use the highway where you can drive faster, although the distance by using the highway is in fact longer (meters). It also does not recognize one way roads. By choosing the size of the sector you want to analyse you have to pay attention, because if you choose a too small sector you will get a wrong result (like my in my case by analysing the city the importance of the Rosengartenstrasse was not visible because of that) and if you choose a too big sector it will calculate too many hours.

In future I will use this tool for analysing closed, not too big and equal networks which lie all on one layer, because then it provides me with crucial information to support my design. Then I see where is what how important and then I am able to test and compare different designs and developments.

BT Section Khayelitsha- Urban Relations

Student: Emma Paola Flores Herrera

Summary:

Being an informal settlement, BT Section in Khayeltisha has no designed nor planned urban layout, leading to having a lack of an urban arrangement that may lead to improve the community's living conditions. A series of analysis of the spatial arrangement of the shacks, lead to the finding of pathways as well as communal spaces which may be called "courtyards".

The specific characteristics being:

- a) every shack should face a public space as well as a courtyard (public and semiprivate facades)
- b) there should be a main pathway in between to an already existing communal space and to a school , both outside and just next to the BT section
- c) this pathway should have several communal spaces
- d) there should be other entrances besides the pathway entrances, which should lead to these communal spaces

Motivation:

The aim of this project is to develop a new well integrated urban layout with specific characteristics throughout only the process of using a proper isovist analysis. The purpose of this is to analyze how designing with intelligibility correlates integration and connectivity. In order to test and prove this statement, an analysis of the integration and connectivity before and after the design process was made, all the analysis being made with a radius of 'n'.

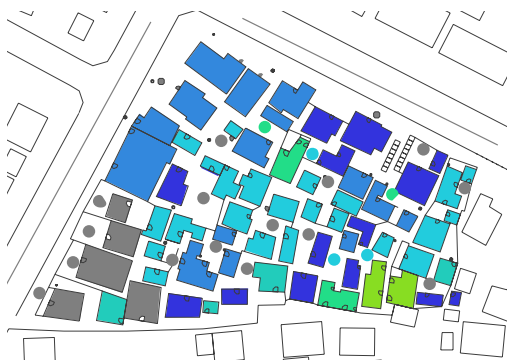

Integration



Integration



Connectivity



Connectivity



Choice



Choice

Analysis 3 (Spatial Syntax III- Urban design through isovist analysis):

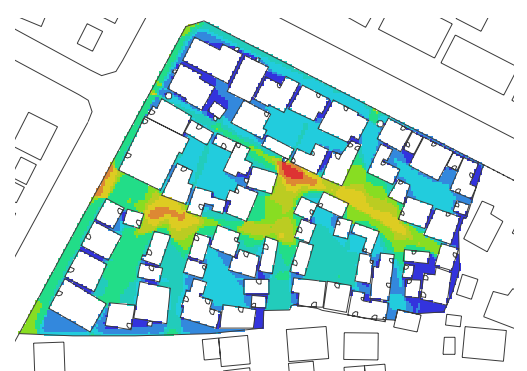
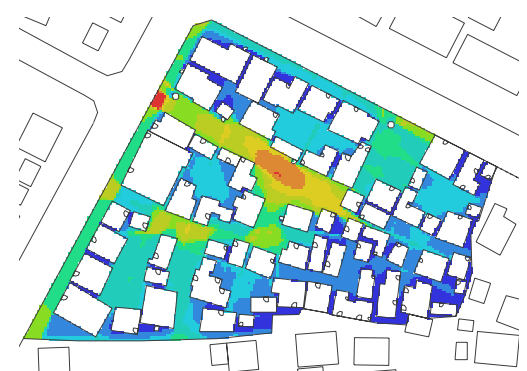
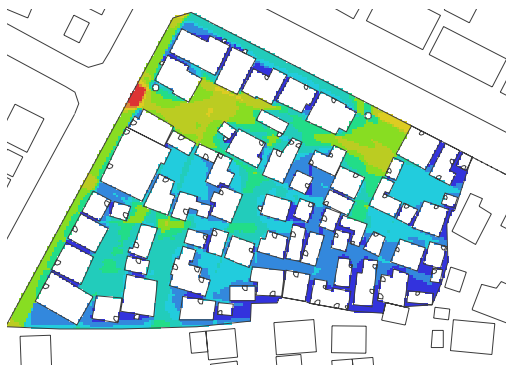
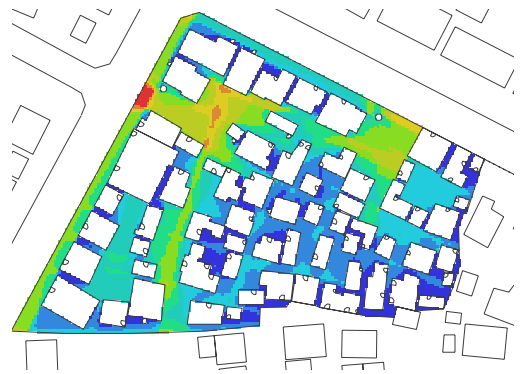
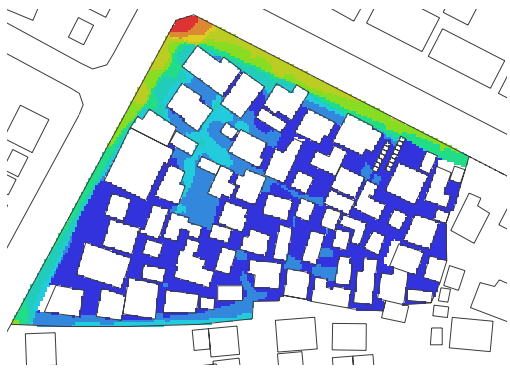

Analysis 3 (Spatial Syntax IV- Isovist analysis y proposed plan):

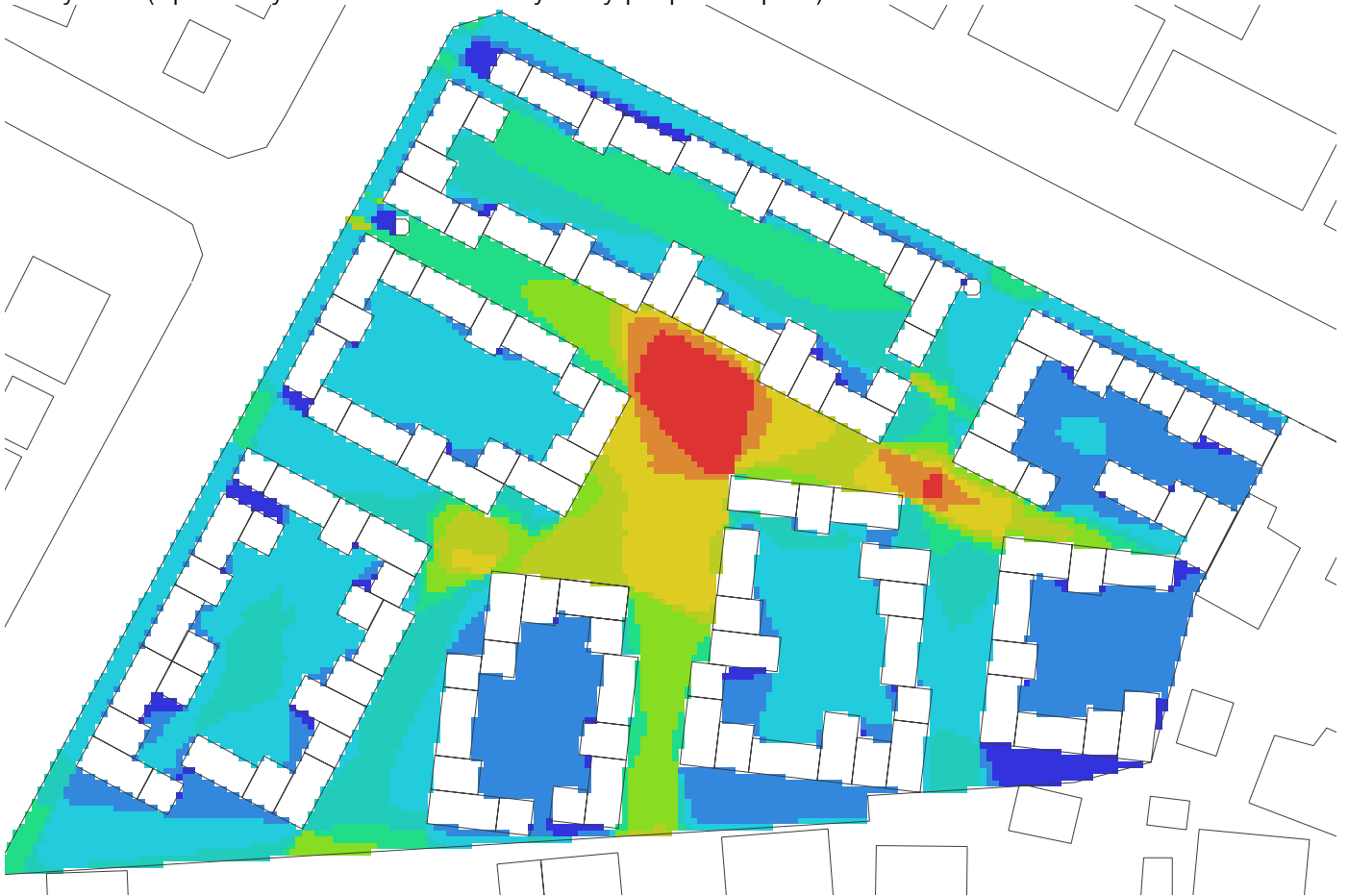

Analysis 4 (Spatial Syntax I- Relations in in between courtyards and shacks in a convex map):

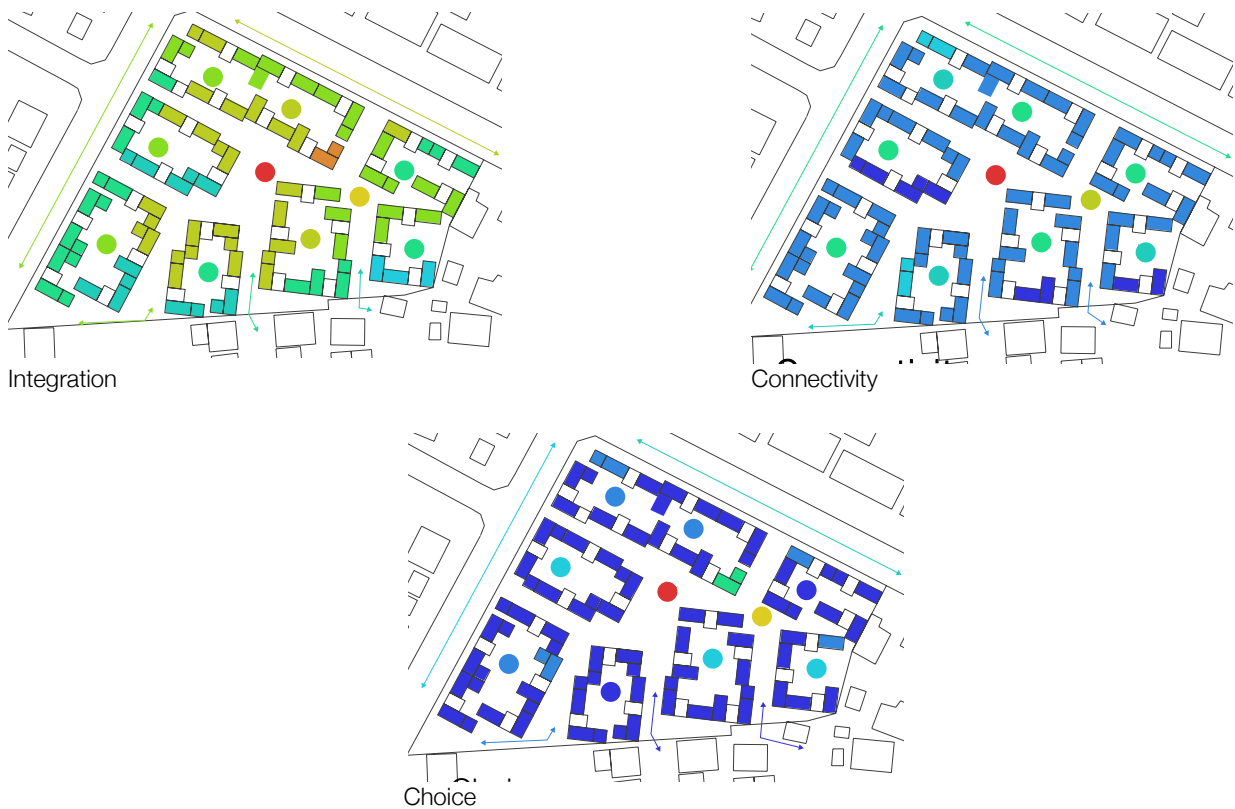

Analysis 5 (Spatial Syntax II- Pathways through the shacks in an axial map):



Conclusions

Supporting the initial statement, design only with an isovist analysis; lead to have a better integration and connectivity in the design. The new urban layout lead every courtyard to have the same connectivity and choice, and lead every shack in the center to be as integrated as any other. The shacks in the perimeter would remain less integrated as they are facing streets. An analysis of choice was also made but was not relevant for the design intentions, therefore having just the intelligibility process needed for creating proper and equal communal spaces. This analysis also enables, after being made, the possibility of finding with shacks are which courtyard re better located, in case a more develop design should be made, in terms of the location of a workshop or a main communal space. This meaning that these analysis could be taken to it's last extents, being a never ending cycle which could stop when finding the desired design.

Commerce and industry of Zurich – An analysis of its transport connection and centrality

Student: Irene Urso

Summary:

Our design studio analysed three major roads leaving the city: Badenerstrasse from Altstetten (sector 9), Schaffhauserstrassen in Opfikon (sector 11) and Überlandstrasse from Schwamendingen (sector 12). All these streets once were country roads connecting all the small villages, now they are major arterial roads leaving the city and important roads in the agglomeration of Zurich. Old industrial buildings characterize the areas around these former country roads - some are still used and some are just fallow. The deficit of those areas is the fact, that these segments weren't planned, so they seem to be some land resource, which are highly underused. Since the producing industry and commerce needs a lot of space for its factories and big industry halls, they get more and more chased away out of the city and need the near land next to the city - such as the three areas analysed in the design studio. The analysis are based on these three areas and reflect the street organisations, centrality of these areas and should show the potential of those and the differences between similar organisations in the city itself.

Motivation:

With the Depthmapx analysis I tried to recognise if there are visible differences between the three areas of the design studio and other situations within the city, if there are differences between central urban spots and suburban agglomeration towns. The analysis should show what the differences between urban street space within the city of Zurich and the (sub-)urban street space of the next agglomeration such as Schlieren are. To do so I compared the situation of the three roads of the design studio with three other areas of commerce and industry within the city - which still exist but are almost extinct.

The result of the analysis could be used to develop a strategy to plan the site. After analysing the bigger scale and finding out which are the spots with the highest potential and quality for commerce/industry, I want to use the analysis tool to develop a new urban structure that combines producing industry, with customer-oriented industry and even living spaces. The tool should help organise the new structure offering for each usage the best and most appropriate space and situation.

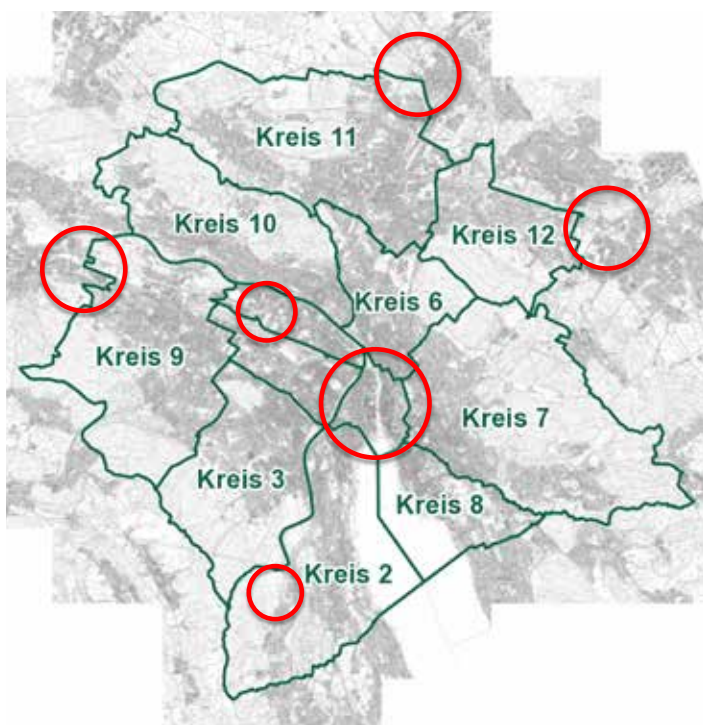

The city of Zurich is divided in twelve sectors / districts. Our design studio analysed three major arterial roads leaving the city: Badenerstrasse from Altstetten (sector 9), Schaffhauserstrassen in Opfikon (sector 11) and Überlandstrasse from Schwamendingen (sector 12). To analyse these streets I compared them to another three areas within the city: Zurich West (sector 5), Zurich Binz (sector 2), Zurich centre (sector 1). For all these 6 areas I run the segment analysis for Integration and Choice.

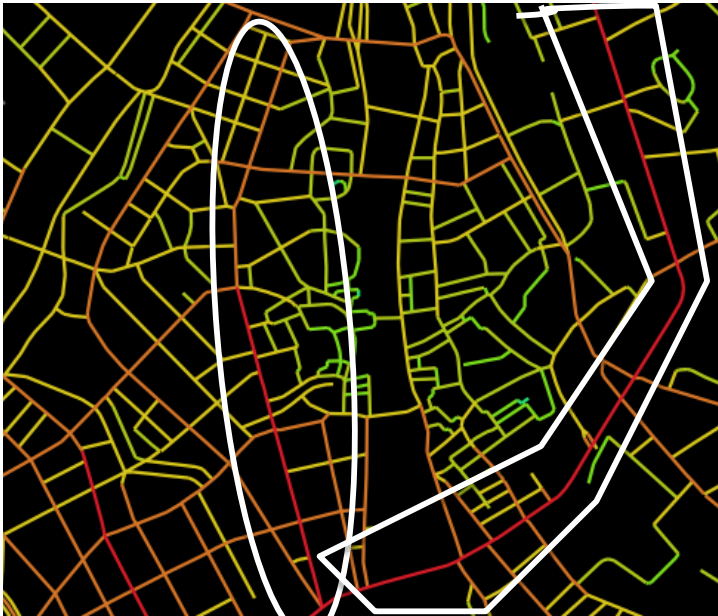

Segment analysis,
 Depthmapx – Integration:
 Example 1 – Zurich Centre
 (sector 1):

In this example you can see that two roads have the highest value in Integration.

The road on the left is Bahnhofstrasse and the on the right is Rämistrasse.



Bahnhofstrasse:

Bahnhofstrasse is a very central street and probably the most popular and expensive road in the City. A lot of stores, jewellery shops and banks are situated along this street. Another special fact of this road is that it's pedestrian only. Cars can only cross the road in the major intersections. Due to it almost straight direction from the main station to the lake it became a very populated and well known boulevard.



Rämistrasse

Rämistrasse is a road that runs from the university of Zurich and its university hospital down to the lake. It is also a very famous and very populated road. A lot of traffic runs down this road, cars, trams and people travel every day this road up and down.



Segment analysis,
 Depthmapx – Integration :
 Example 2 – Zurich Binz (sector 2):

Zurich Binz is a neighbourhood in sector 2 and is characterised by old structures used for beverage companies and other industry companies. There have been a lot of changes in the last years, trying to develop these old structures. Some have been reused for new enterprises, producers and craftsmen but also for the service sector. The area lies near the highway and can be reached in a few minutes from the main station.



Supertanker:
 Structures like this have been re-organised and are home to small enterprises like Shikar Group or VB lighting, some rooms are used as showroom and in some office spaces are several architects. Even though it seems not to be very near to the centre of the city, this area is very good connected to the highway and to the main station of Zurich. Due to the situation it has perfect condition for delivery and supply. In the last year it has developed from a space to a creative and popular work space for different people and work sectors.



New living-neighbourhood:
 But like in the rest of the city the need and demand of cheaper living spaces makes it really hard to enforce such spaces for the industry, particularly for the manufacturing trade. Where once were industrial halls now are new houses. The City of Zurich built these with the intent to provide cheaper housing.



Segment analysis,
 Depthmapx – Integration :
 Example 3 – Zurich West
 (sector 5)

The horizontal red and orange lines are roads that come from the highways and continue as main roads towards the centre of the city. The one in the diagonal direction is the Hardbrücke, a bridge that connects Zurich West with the Highway in all directions.



Pfingsweidstrasse:

This street leads us from the Highway directly into Zurich West and this old industrial neighbourhood. These old industrial infrastructures are partly still in usage but mostly have been changed into some event halls, provisional usages or they just lie fallow and wait to be demolished for new infrastructures. Hardturmstrasse: Like Pfingweidstrasse this road leads from the Highway directly past Zurich West and towards the heart of the City, the main station of Zurich.



Development:

In some parts of this area investors have developed these old structures by tearing them down and building new metropolitan infrastructure as for example the Prime Tower and his area around. The industry has not only been mostly sent away, the prices have increased so drastically that every small enterprise struggles to stay and all structures of the former industry are fighting with the pressure of the investors.



Segment analysis, Depthmapx –
Integration: Example 4 – Altstetten-Schlieren
(sector 9)

Badenerstrasse: The street pointed out by the yellow arrow is Badenerstrasse, which runs from the city through the whole Limmattal and connects all the small cities and villages up to Baden. This road is very heterogenic, it has a high traffic volume, on the right side (picture) are mostly living homes and some small stores, and on the left side there are mostly industry buildings and leftovers of the former Wagon-factory.



Bernerstrasse:
The upper road (white arrow) instead is the Bernerstrasse. It's a parallel street but with mostly pass by traffic and heavy transport. This road is characterised by the Gaswerk, where the old halls and for example the old water tower are and of course the Gaswerk itself. This is also an industry area where big logistic centres and companies are situated. The difference between this area and the area around the Badenerstrasse is, that the Badenerstrasse lies between the centres of Altstetten and Schlieren and the Bernerstrasse lacks any kind of centre but is instead very isolated, even though well connected.



Segment analysis, Depthmapx – Integration:

Example 5 & 6 – Opfikon (sector 11) and Schwamendingen (sector 12)

Überlandstrasse: This road is also an old land road that originally connected the small villages in the neighbourhood. During the last 50 years Schwamendingen has grown and developed to a garden city

and the Überlandstrasse cuts through and isolates the strip on the northern side of the road. Due to this big border the strip has not been developed and has a lot of potential for the producing companies and industry.



Schaffhauserstrasse: Schaffhauserstrasse is a parallel street to the Thurgauerstrasse, which is known for the Glattpark, a new neighbourhood that has been developed in the last 10 years. The Schaffhauserstrasse is very heterogenic, being characterised by bigger Infrastructures of research institutions, old small living houses, and old industry buildings. The difference between the Schaffhauserstrasse and the Überlandstrasse is that in Opfikon the road is situated in the centre and in Schwamendingen on the edge.



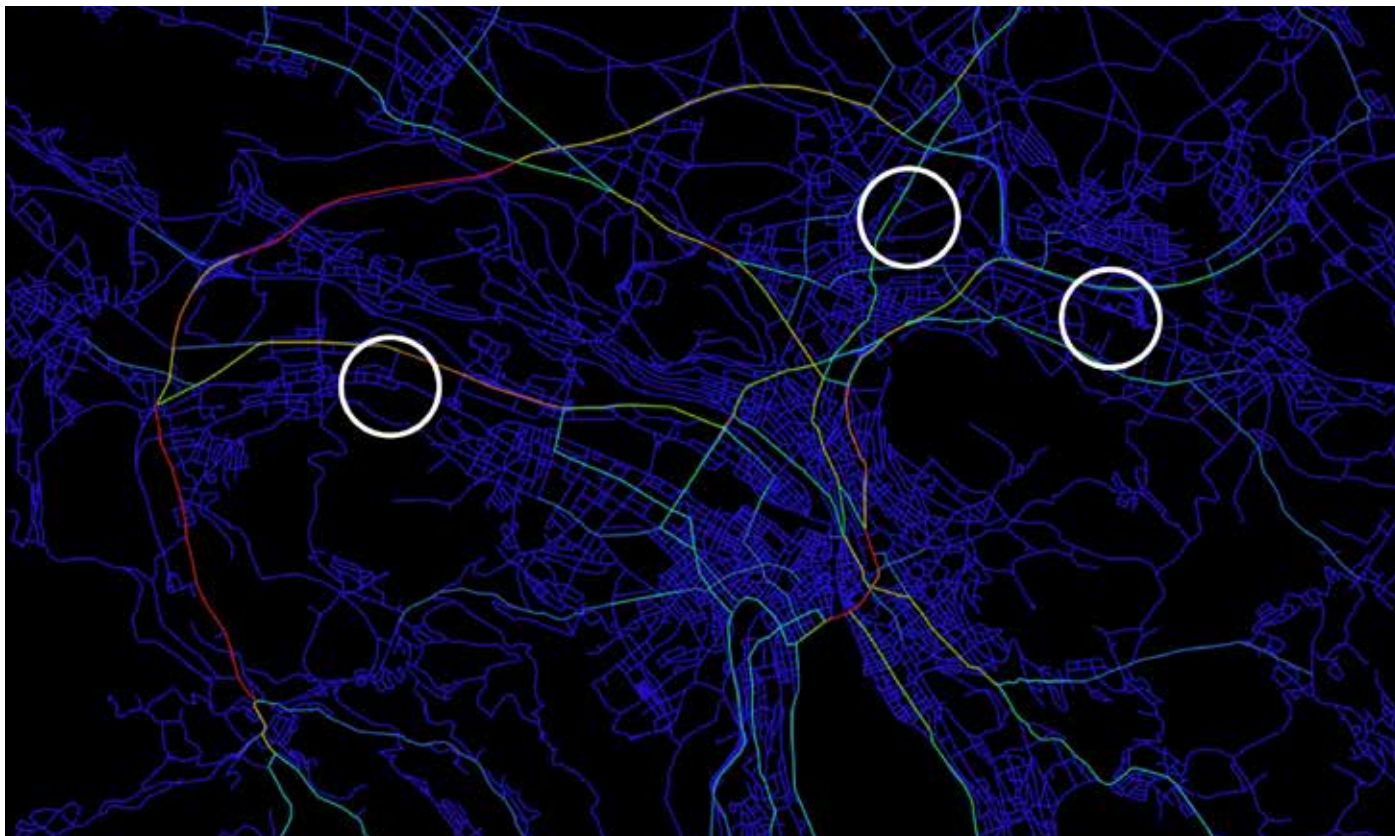

As the Choice analysis shows all these three areas lie not only near important streets, but actually around these roads. They are situated between the city and the highway connections. After the City has developed to a very dense populated area, these three agglomerations-cities have the best potential for the industry that needs space for their infrastructures so urgently. Even though the city has a denser grid and therefore the streets have a higher connectivity respectively to the outlying spots of the agglomeration, zooming out you can see that the centre of the city has not the highest choice value but the roads on the edge or as the tree example even out of the city instead. So confronting those kind of enterprises that need the contact with the customer and those which need space for their production you can find for each the better location.





Due to the choice analysis of the street net, the area of Schlieren should be subdivided in zones for the producing industry sector and the customer oriented industry sector:

 Areas that lie around the important road, here Bernerstrasse: Location has the best potential for big company from the producing industry sector

 Area that lie on secondary roads, here Badenerstrasse: Location has the best potential for smaller company from the customer oriented industry sector

Conclusions of the Integration and Choice Analysis:

In every of the six situations the Integration analysis shows that despite which kind of commerce and industry it is, their location is always surrounded by well connected street system or as in the three neighbourhoods of the design studio they even developed to be along these roads. Despite the development of the industry in the last decades, the big industry infrastructures were once built where the bigger infrastructure was, they were built near the highway entry or exit, along the riverside, or where the train station were. But cities like Zurich have spread in Switzerland, growing and absorbing all these smaller cities and towns. What once was the border of the agglomeration and where the industry was located are now big centres with living structures, working places, and research conglomerations. And the pressure of housing demand and the high prices of land and rental fees make it impossible for the industry companies to survive in the city. But because it's important to have them and because they can contribute to a qualitative and heterogenic environment the city has to ensure that the last spots that still exist will be preserved and that this companies find space in the vicinity of the city, that is the agglomeration towns like the three examples – Altstetten/Schlieren, Opfikon and Schwamendingen. The Integration analysis showed, that where the infrastructure is and where it lies central, there you can always find uses that need exactly these properties. So for example, you can find the expensive and exclusive shops at Badenerstrasse, you have the University Campus with its hospital at Rämistrasse, Zurich West has developed due to its very good location and mostly important due to its good connection, to a new centre with skyscrapers and expensive flats. But infrastructure is also attractive or substantial for the industry and big companies. The difference between these two situations is though that stores and shops need to be near the customers and big industry companies need to be easily attainable. The Choice analysis shows exactly this difference. So the advantage of these three areas (Altstetten-Schlieren, Opfikon, Schwamendingen) is that their central roads not only have a high choice value, but also that they run through this neighbourhoods, providing a perfect location for the companies and simplifying their supply.

Segment analysis, Depthmapx – Integration: (Altstetten) Schlieren:



The spot in the circle should be improved by planning new roads: first a deliver-road in the back, where the railways are and secondly vertical roads between each complot.



The Integration analysis doesn't show any difference for the Badenerstrasse unfortunately. But it changes the value for the Bernerstrasse to a even higher one.

Isovist analysis, Depthmapx – Connectivity: (Altstetten) Schlieren:

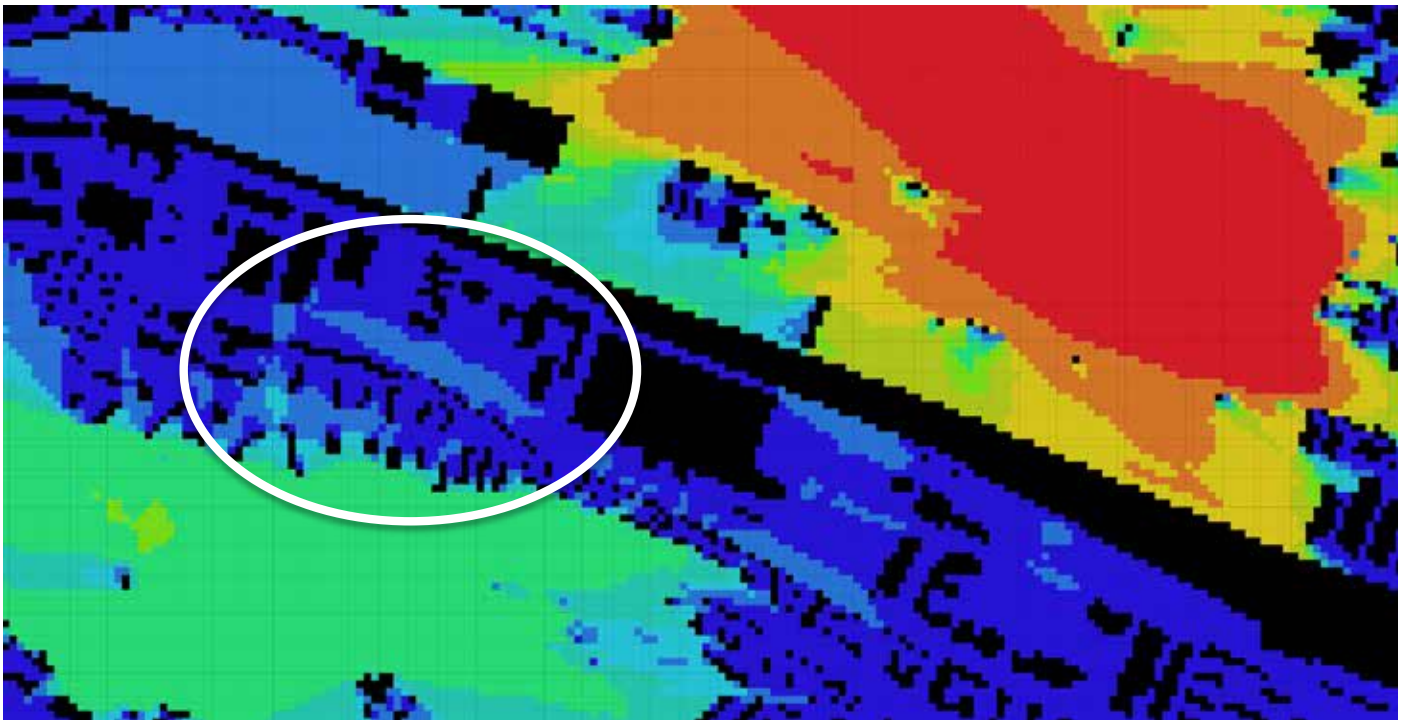

The Isovist analysis shows that in this spot the Badenerstrasse has a better connectivity than in other parts of the street. This fact should be used to implement new structure that should serve to integrate customer orientet industry and commerce in combination with residential use. The Isovist analysis of before and after this intervention shows that it doesn't change much the situation in the spot, but it changes the situation in the lower part, where the value rises relatively due to the intervention.

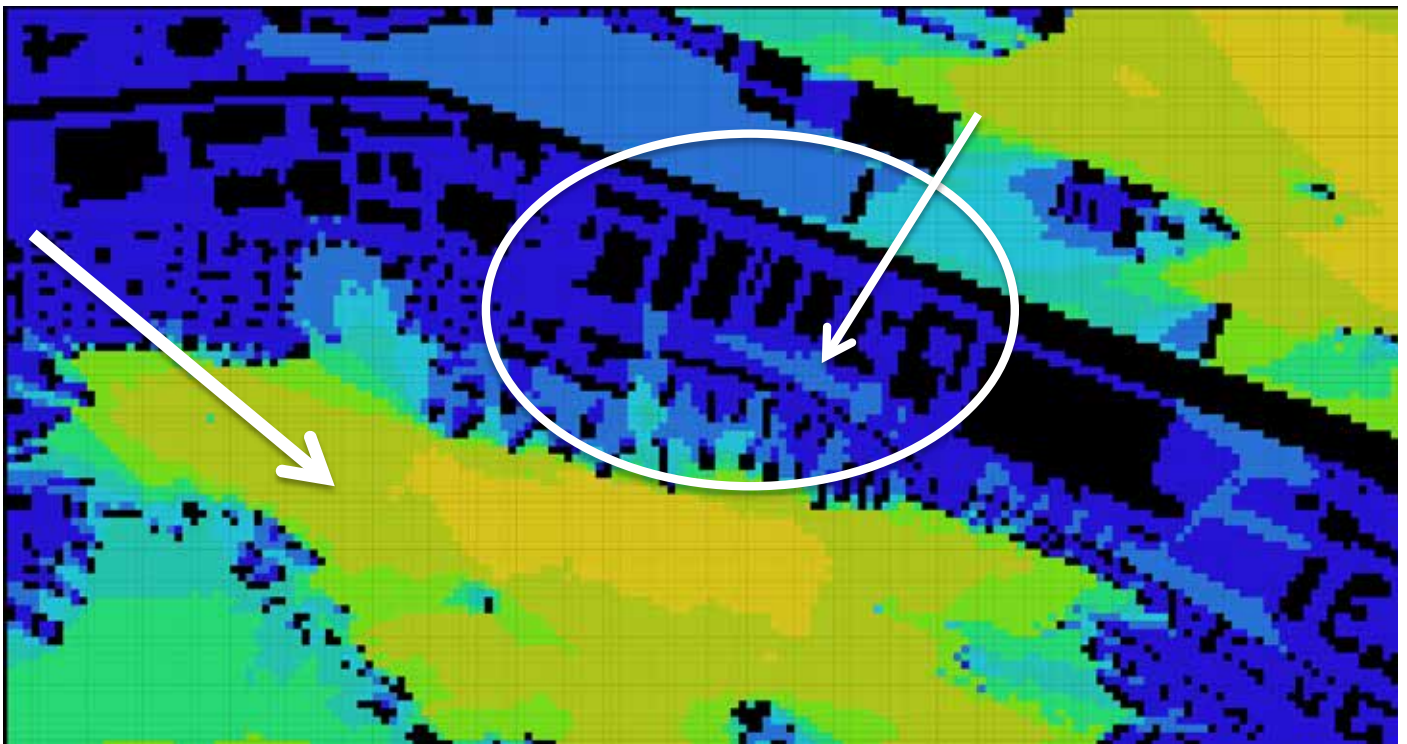

Applying the Solar Envelope Concept to the Reorganization and Massing of the Hunziker Areal with Grasshopper-Geco and Ecotect

Student: Marc Lallemand

Summary:

The Solar Envelope concept provides geometrical guidance for the organization and massing of developments areas such as the Hunziker Areal in Zürich. The solar envelope bounds the massing of buildings and can be used to help justify angular designs which celebrate solar angles. This concept can be neatly examined using the tools presented in the Digital Urban Simulation course.

When this method was applied to the reorganization and massing of the Hunziker Areal a reduction in the shaded footprint of 26% was achieved when measured at 9.00 and 15.00 at the winter solstice as compared to the as-planned Areal.

In order to demonstrate that the solar envelope concept can be applied without a complete redesign of the Areal, the individual footprints of the as-planned buildings were held constant but simply re-organized relative to one another, and then extruded to acceptable heights and cut according to the solar envelope. In doing so, massing of 6% less constructable volume of the Areal was obtained. Optimally, when applying such a concept from scratch the footprint of each building would be designed to fit the environment and in doing so would be less limited in the total constructable volume.

The Grasshopper-Geco plugin worked well for this type of organization and massing exercise. Additional design support was accessed directly in Ecotect however the software was not able to produce heavy visualizations as desired.

Specifically, part of the motivation for this work was not achieved due to limitations in the Ecotect software. This was to produce a visualization of the cumulative sun (LUX) incident on the façades of the proposed building volumes. In order to attempt this a tool was developed in grasshopper to produce and control the meshed surfaces of the mass model. It was not possible however for Ecotect to compute a visualization based on a mesh with adequate granularity.

Instead a visualization of the Areal ground plate using an Ecotect grid was computed. From the results one is able to visually compare the shading in the as-planned to the reorganized Areal design. Exact numbers regarding the shaded area were calculated using Grasshopper-Geco.

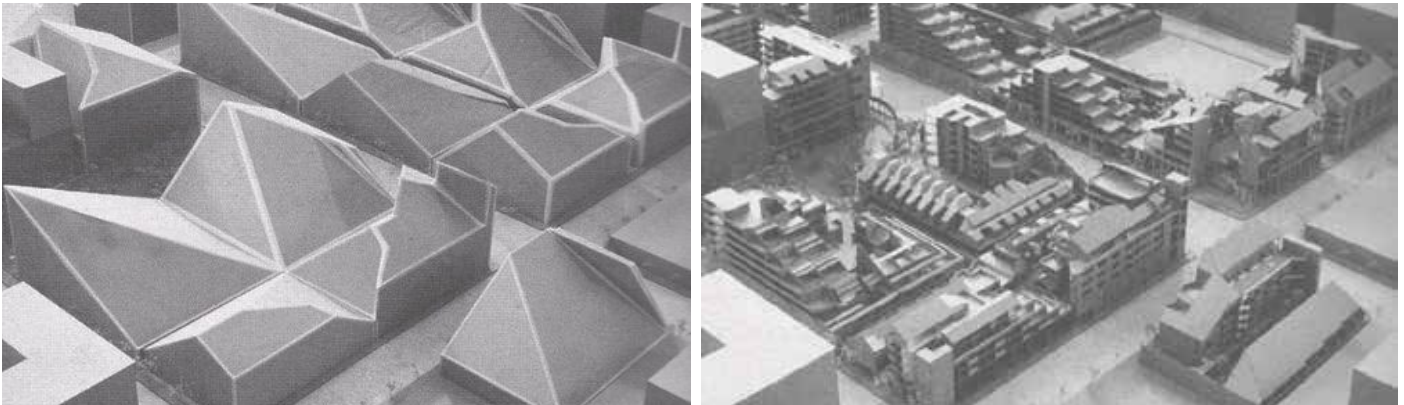
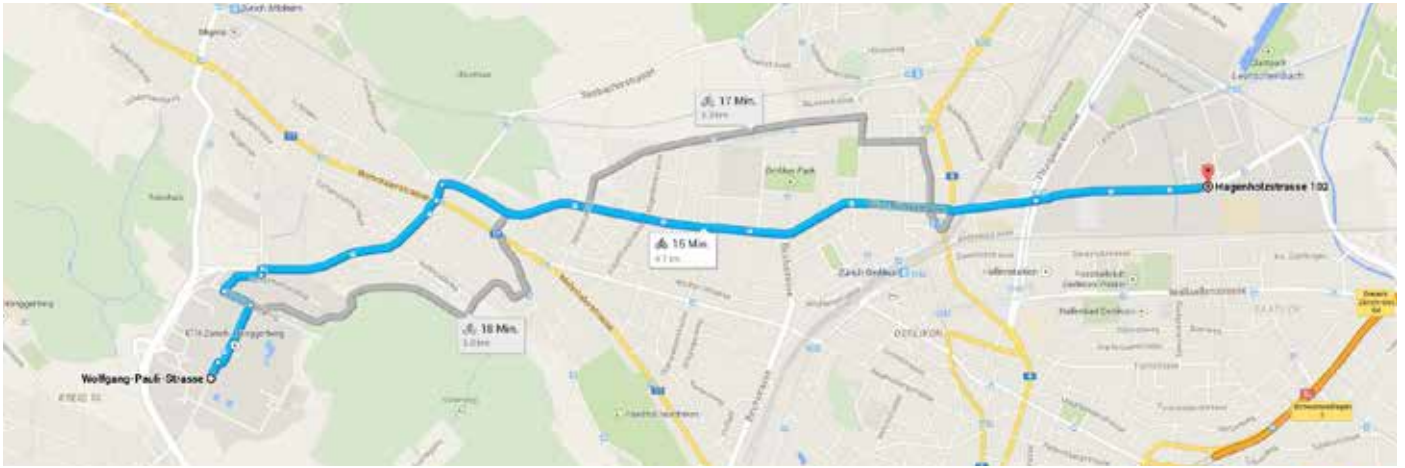

Image Source: <http://www.resilience.org/stories/2012-03-26/solar-envelope-how-heat-and-cool-cities-without-fossil-fuels>

Motivation:

I am interested in the organization, analysis and optimization of entities within the boundaries of a given environment. This was the basis for choosing to analyse the development of the 13 buildings of the Hunziker Areal in Zürich, by applying parametric tools. I also wish to explore architectural design strategies which are based on simple and understandable geometries. This was the choice for the analysis of the Solar Envelope concept developed by Ralph Knowles at the University of Southern California. The forms generated by the solar envelope are angular in nature, celebrating the solar angles, though in opposition to the standard urban grid, which makes it architecturally interesting for examination. Furthermore the solar envelope has the potential to achieve simplicity by passively making buildings more efficient in their environment and thereby reducing the need for additional active building systems.

Finally, I was motivated to find a simple parametric methodology in order to visualize the incident sun on the façades of the proposed building so that one could easily determine the expected sun at each window position.



Hunziker Areal Relative Location



Areal Situation



Actual Site Plan

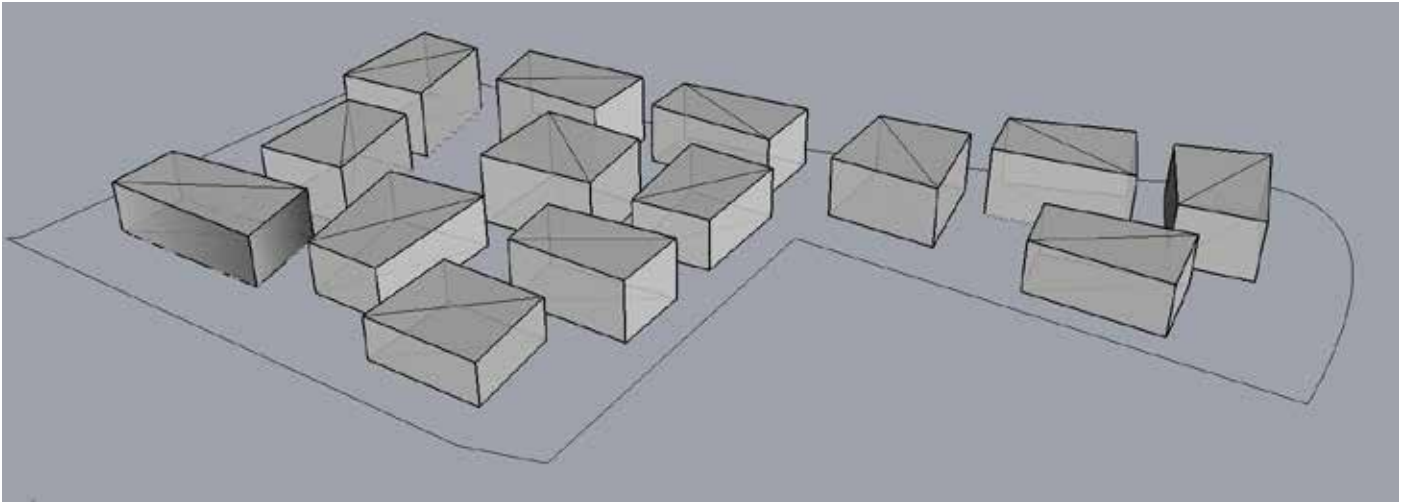

Areal Volumed

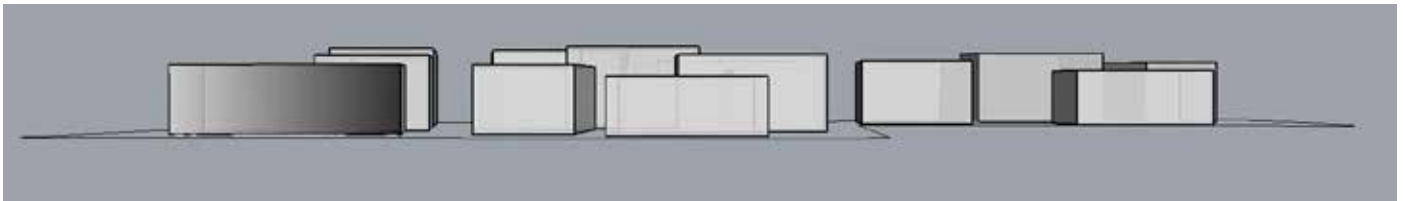

Actual Site Plan

Shadow Ranges According to City Grid

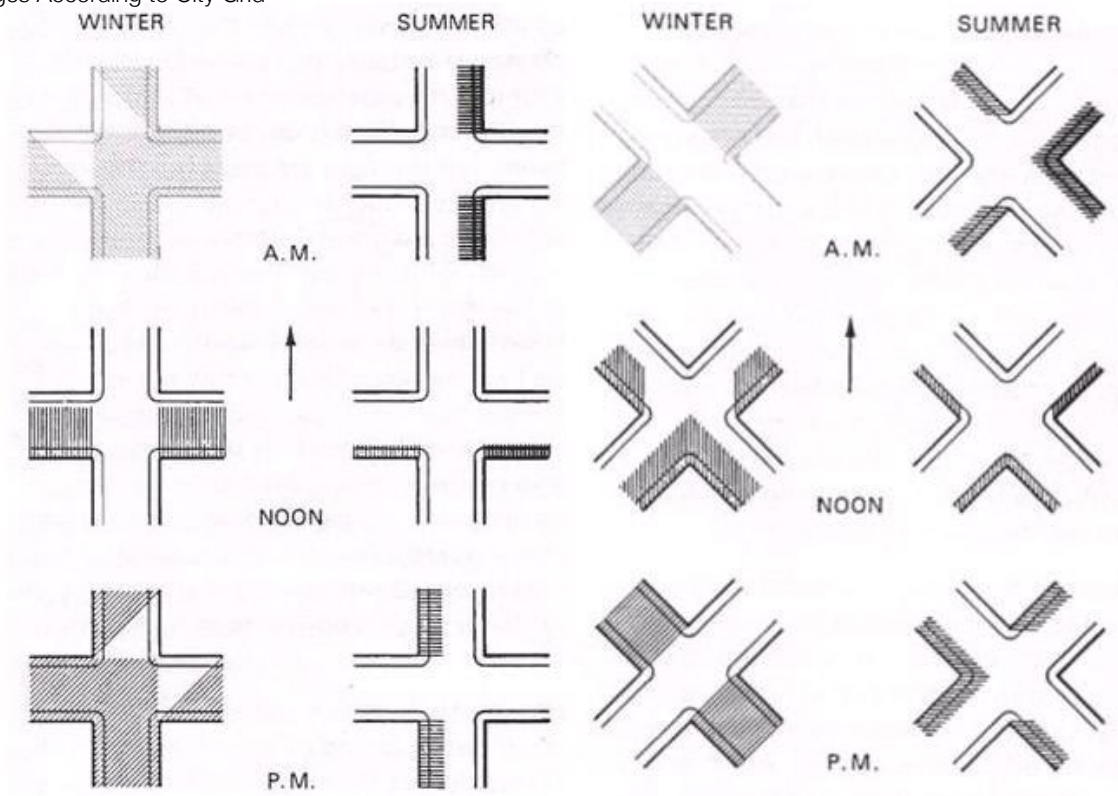

City Grid Source: <http://www.resilience.org/stories/2012-03-26/solar-envelope-how-heat-and-cool-cities-without-fossil-fuels>

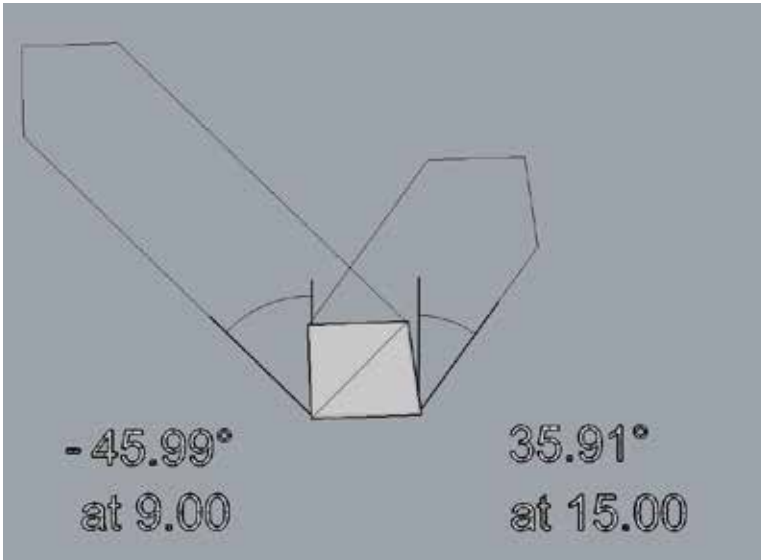

Winter Solstice Shadow Projections on Building I

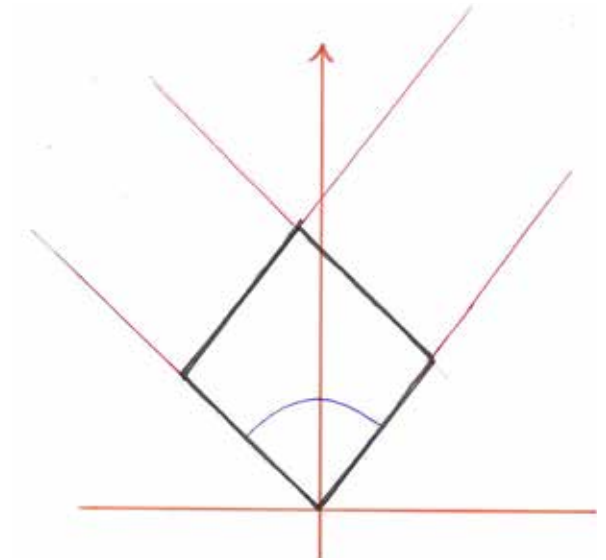

Optimal Orientation of Buildings for Reduced Shadow Area

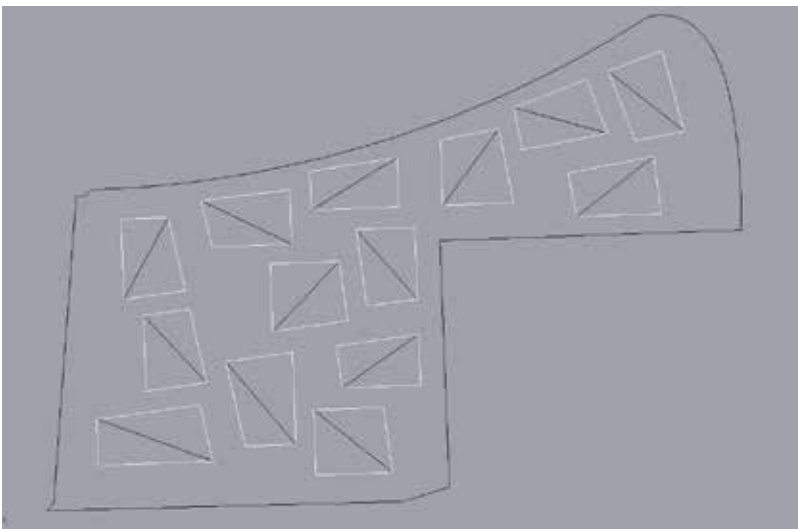

As-planned Grid and Building Characteristic Angles

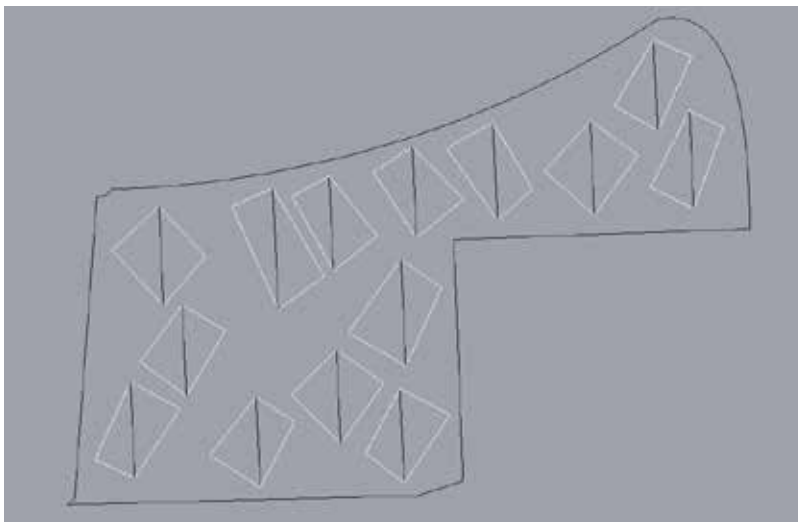

Reorganization of Buildings by aligning to Optimal Orientation

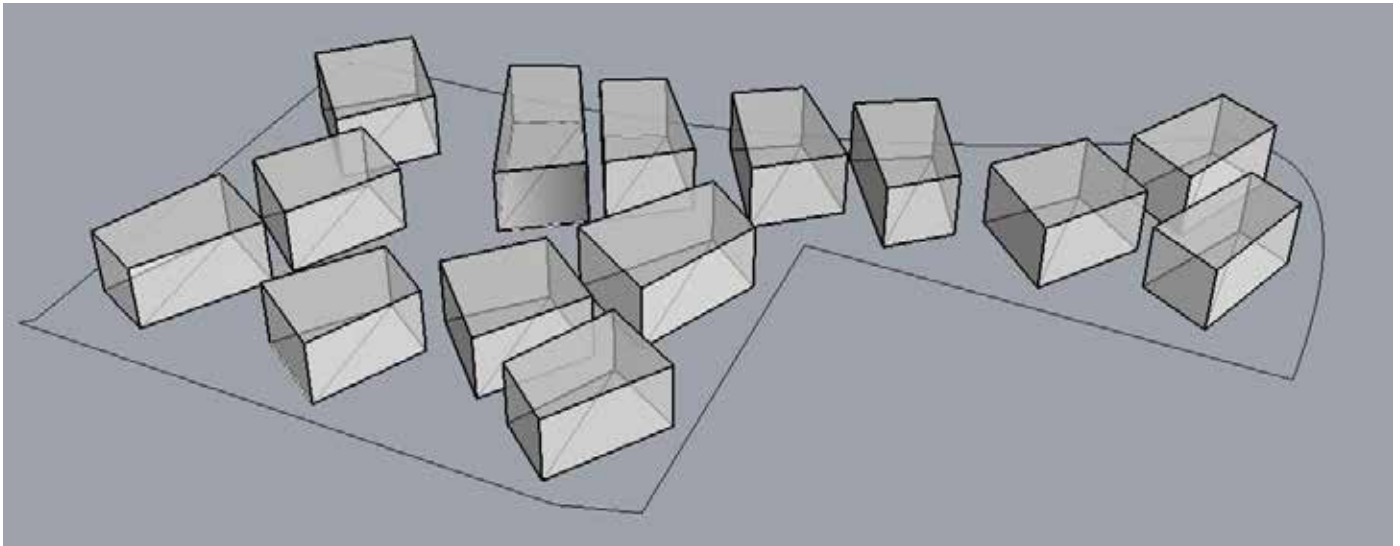

Volume Extrusion of Reorganized Buildings with Maximum Height of 22.1m

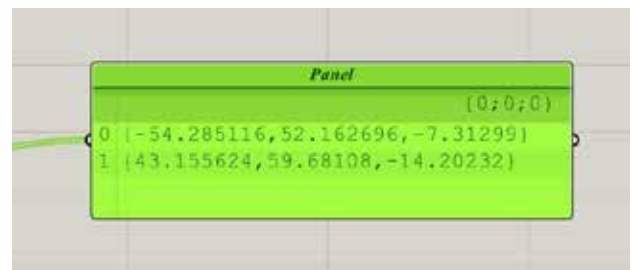
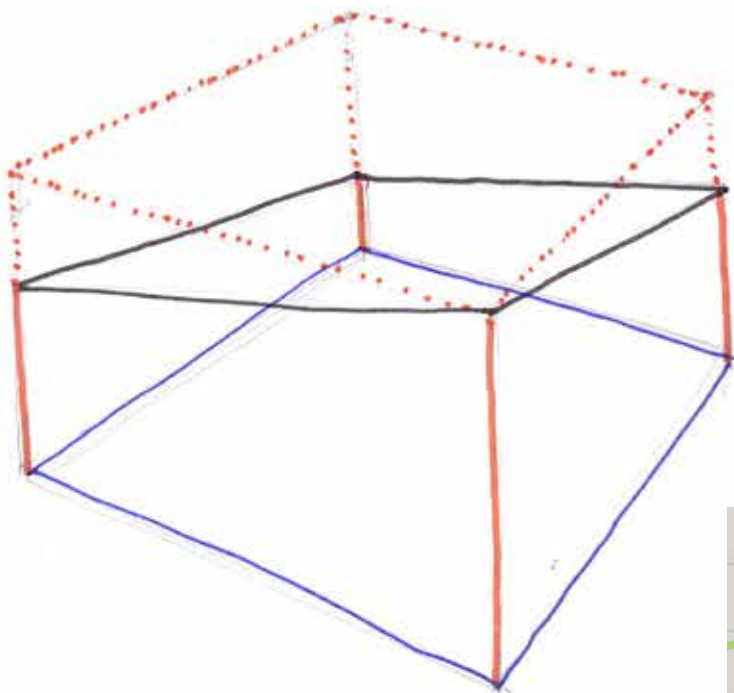

Solar Altitude Angle forms the Cutting Operator - Exact vector calculated in Grasshopper

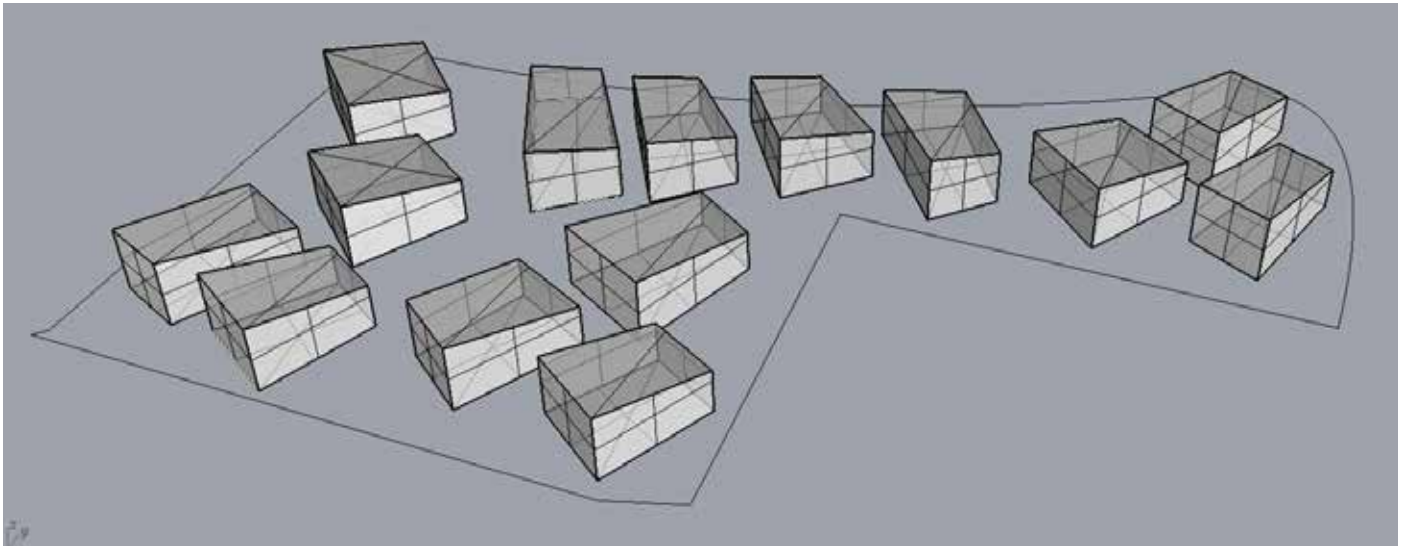

Final Volumes of the Reorganized Hunziker Areal according to the Solar Envelope Concept

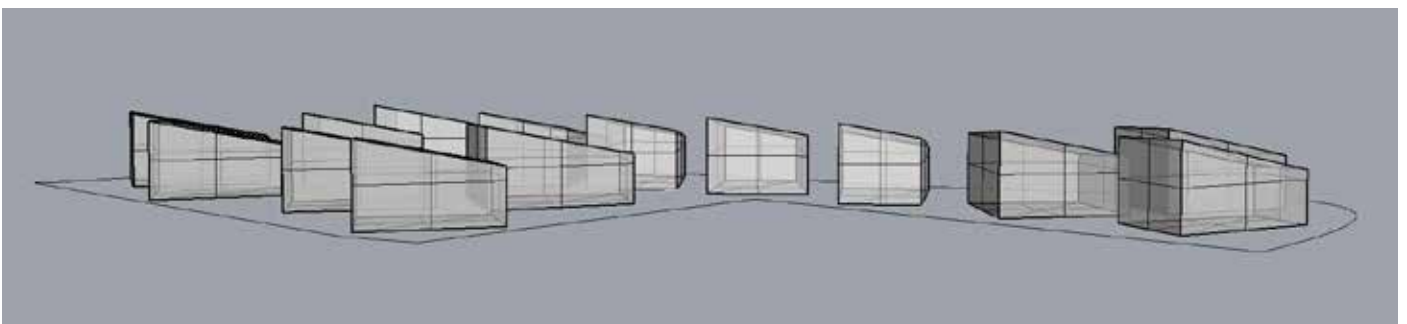

Viewed from Winter Solstice Sun Position at 9.00

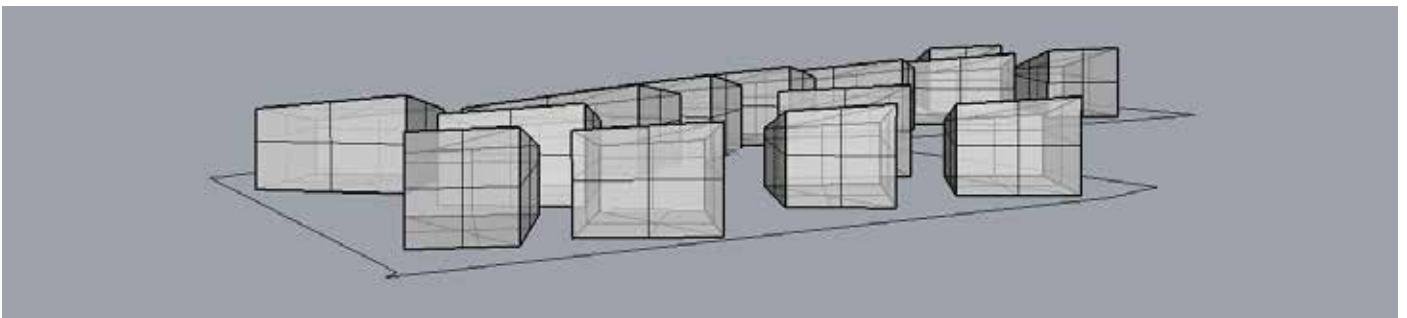

Viewed from Winter Solstice Sun Position at 15.00

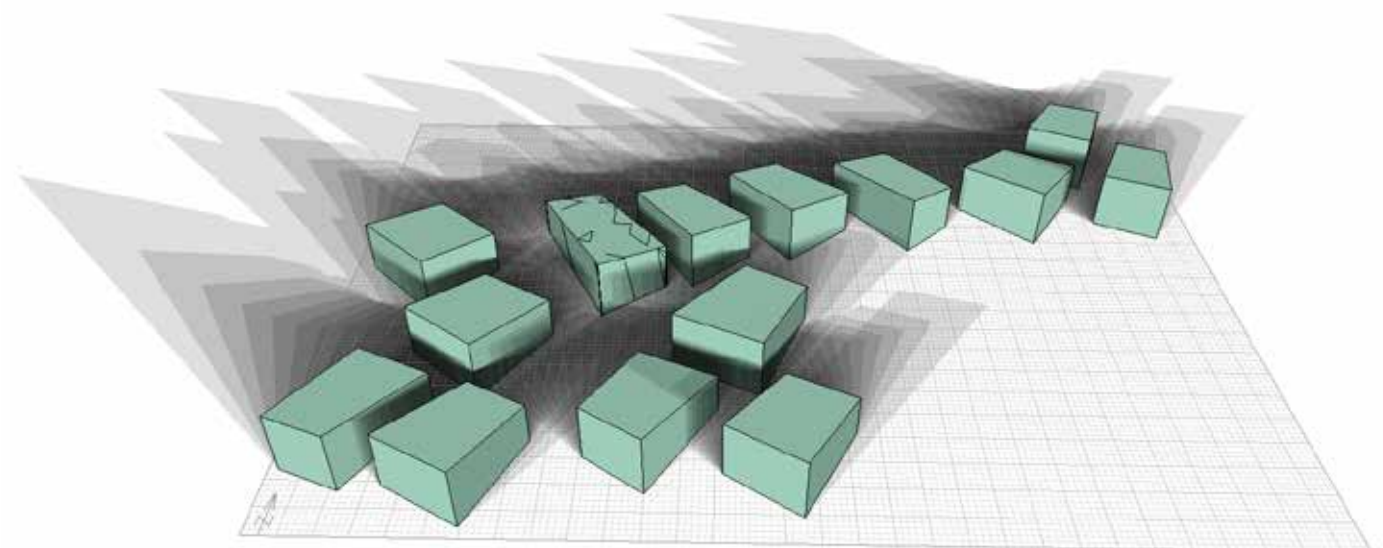

Winter Solstice Shadow Range Analysis 9.00 to 15.00 as Reorganized

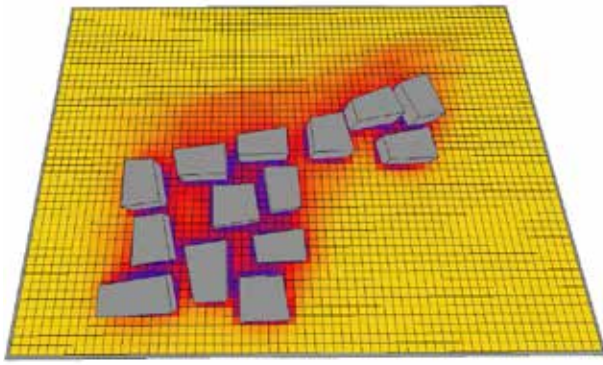

Winter Solstice Insolation Analysis as-planned

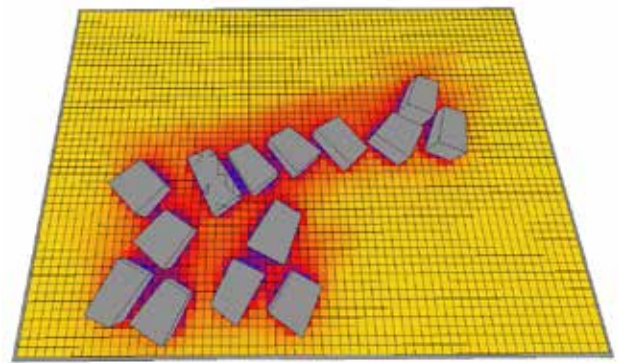

Winter Solstice Insolation Analysis as Reorganized

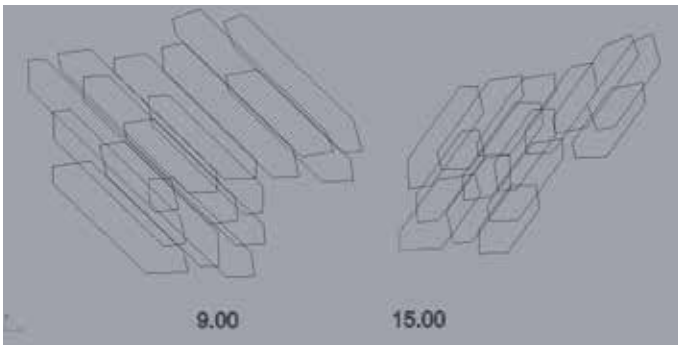

Winter Solstice Shadow Snapshot - Areal as-planned

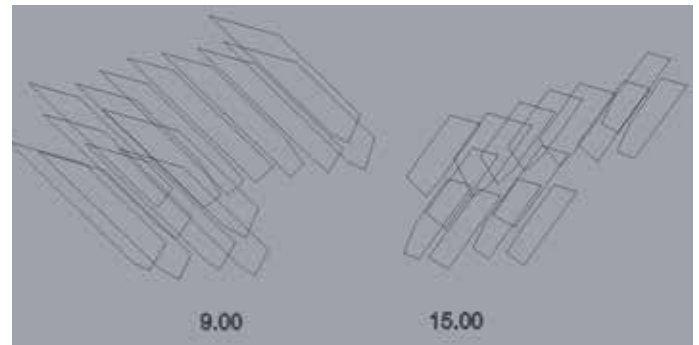

Winter Solstice Shadow Snapshot - Areal as Reorganized

Difference in Shadow Area Snapshot

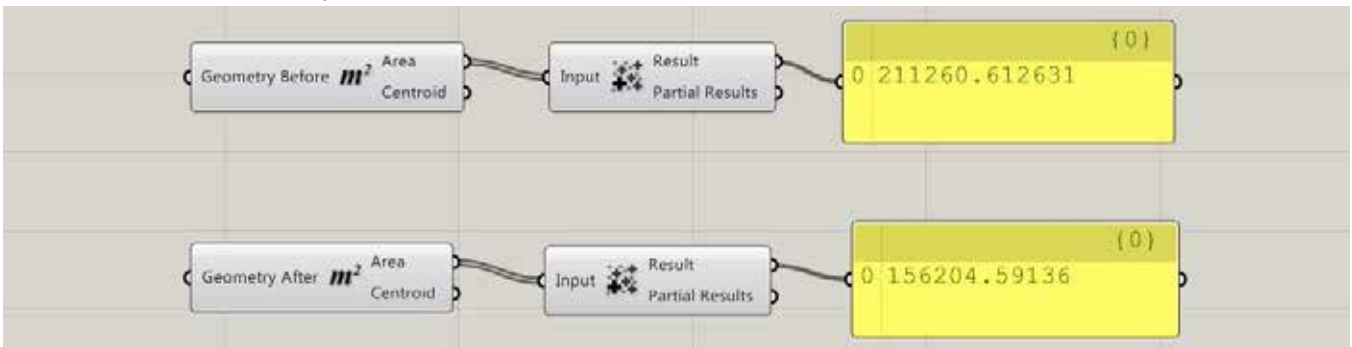

$156.204 / 211.260 = 74\%$; Reduction in shaded area by 26%

Difference in Constructable Volume

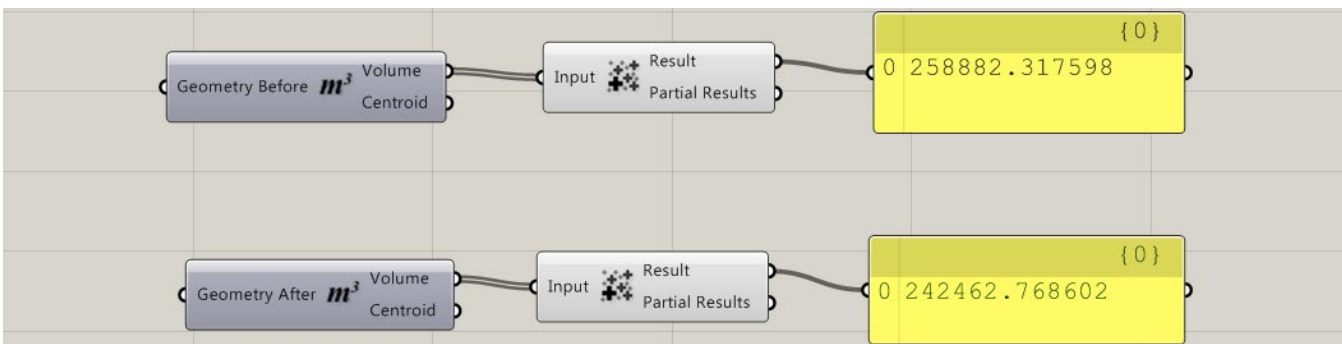

$242.462 / 258.882 = 94\%$; Loss of constructable volume of 6%

Limitations:

Limitations were encountered when trying to produce a visualization of the cumulative sun (LUX) incident on the façades of the proposed building volumes. In order to attempt this a tool in Grasshopper was developed to produce and control the meshed surfaces of the mass model. Once imported into Ecotect it was not possible to compute the Insolation for such a detailed mesh. Less detailed meshes were also attempted, as well as individual façades of the model at a time though it was not possible to generate sensical and communicative visualizations.

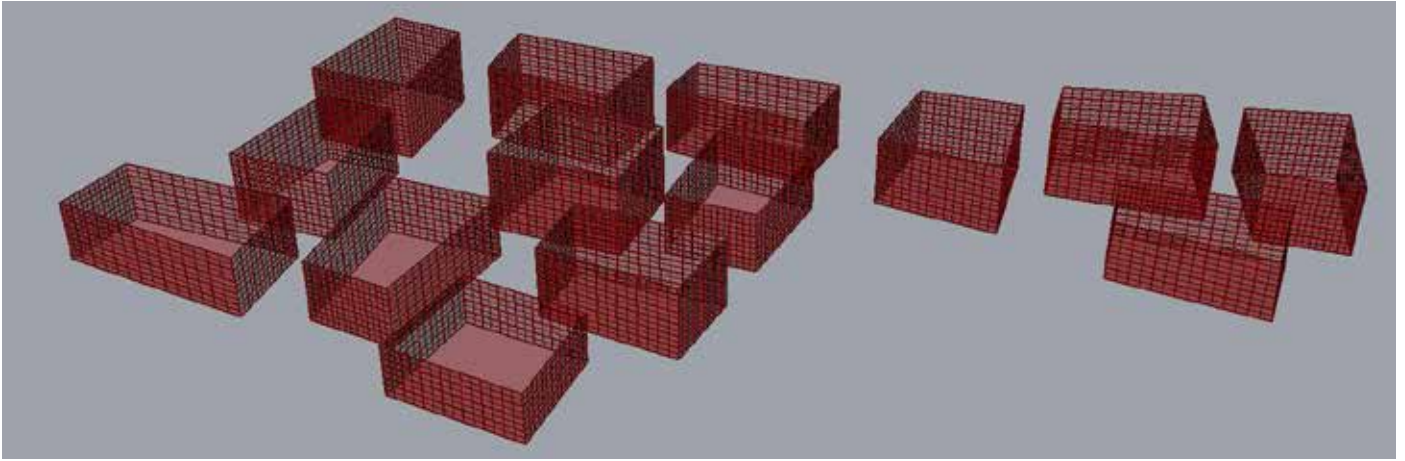

Meshed Model Based on Grasshopper Tool

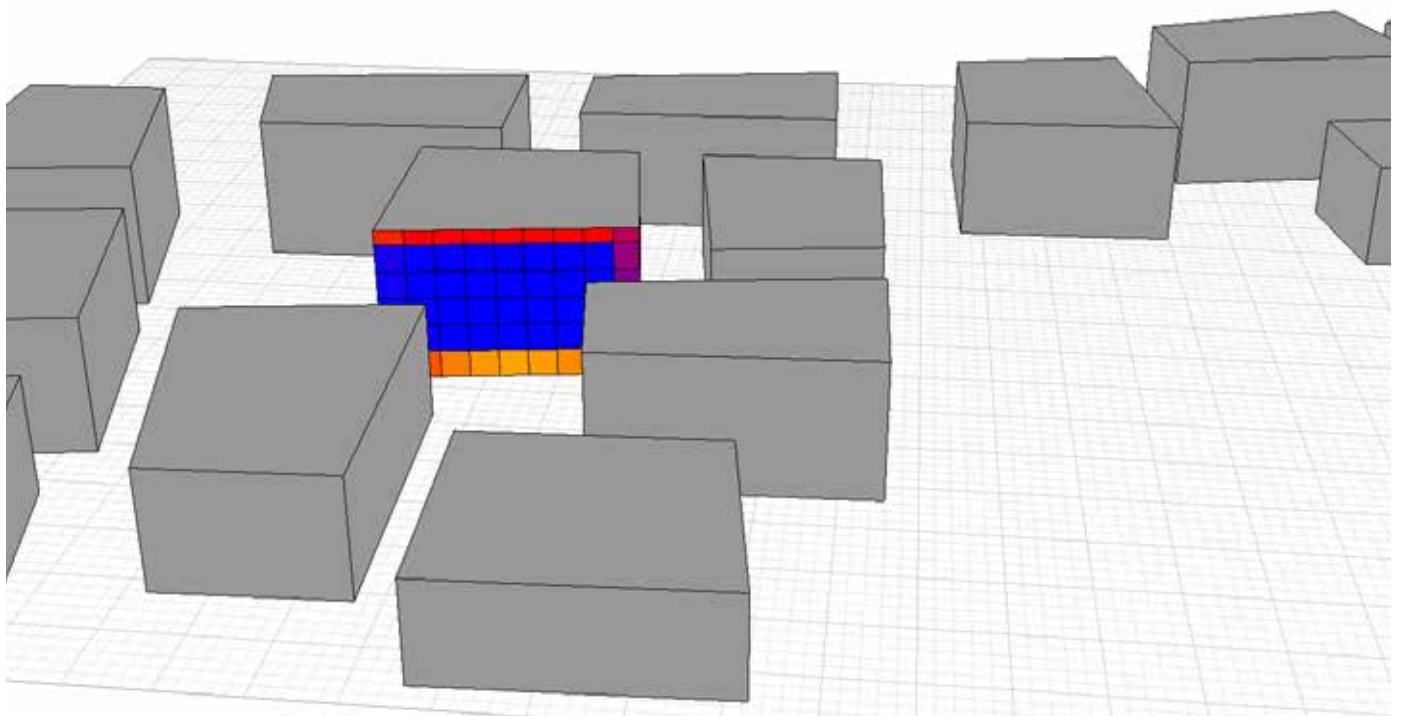

Ecotect Non-logical Results

Conclusions:

- The Geco plugin for Grasshopper brings the power of Ecotect into Rhino for modelling and massing
- This toolset allows one to neatly analyse the solar envelope concept
- The solar envelope is a valid design methodology to reduce shaded area of a development
- The solar envelope concept generates angular aesthetics, celebrating solar angles
- In the Hunziker Areal example, loss in constructable volume could be avoided by modifying the individual building footprints to fit the environment
- Ecotect provides targeted design insight, though struggles with producing heavy visualizations

Further Explorations of the Hunziker Areal:

Through the motivations and the development of the assignment certain ideas for further exploration have been developed. For one, as a design strategy it would be interesting to define the bounding envelope of each building according to the solar angles however modulated by the proximity to neighbouring buildings. It would also be interesting to redesign the footprint of each building in order to fully implement a version of the Spanish grid system which is fitting the environment of the Areal, rather than holding the building footprints constant as was done in the example.

Finally, it would also be worthwhile to find a methodology to successfully visualize the cumulative sun (LUX) on the surfaces of the building volume. This would allow one without much effort to say how much sun each window position on the facade would receive.

BT Section

Student: Thijs van der Lely

Summary:

The BT section in Khayalitsha, South Africa is a part of the big network of Townships that have spread out over the Cape Flats. These Townships are know to be extremely dangerous and have been known to be one of the most voilent places in the world as one of its murder capitals.

The lack of structure in the urban plan is one of ther reasons why there is little to do for police and control from the community them selves.

The shacks have been scatterd of plot areas through squatting on a location and building up there houses. Through this proces the urban plan has become a network of small streets that can not be controlled and a vast number of alleys and corners where people can hide.

The task of the design studio was to rethink the way the houses have been built and find out if there is a way to, through design solve aspects of security of the inhabitants, create clear structure in the urban plan and think about social control.

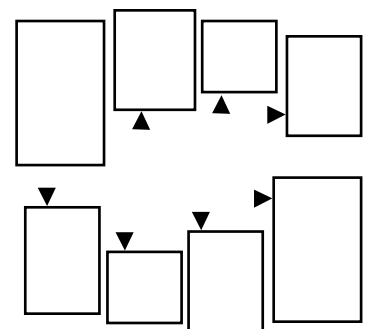
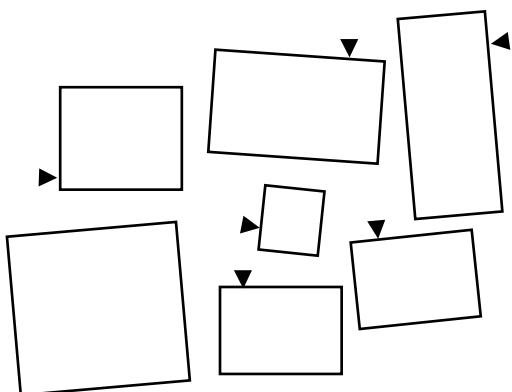

Motivation:

To understand the problems that are related to the security situation and the lack of structure in the current urban plan the use of digital analysis tools can have a big impact. During this research project I want to see if it is possible to use these tools as a means of understanding and pinpointing the problems in the urban plan and its lack of hierarchy in the streets and it being a clear plan as well as see if the tools can help me as a tool that can be used to test ideas and see if they are a starting point for finding a solution.

For me an important part of using these tools to understand the situation and helping to find a solution is that it will not drive to a conclusion but merely recommend paths that can be taken to create a more clear urban plan. As the urban section will always be heavily influenced by inhabitants that do not rely on a topdown approach it is important to understand bottom up logic to generate a more clear urban situation. To do so I will generate a design strategy built up out of local rules of interaction between agents in the plan to generate a global smarter system that may impact to more structure and a clearer urban plan. Also it is important too use the human reaction to a plan and use a commonsense approach that can not be linked to an algorithm. At the start of the project the community will always contribute to the project and will start with a negotiation of space. The point where a negotiation can start is what I aim to achieve through an algorithm. From this point the human interaction to the plan will start and will influence the final layout. But due to the starting point already being related to rules that generate a basic clear plan the outcome will always be more clear than if this was not the case.



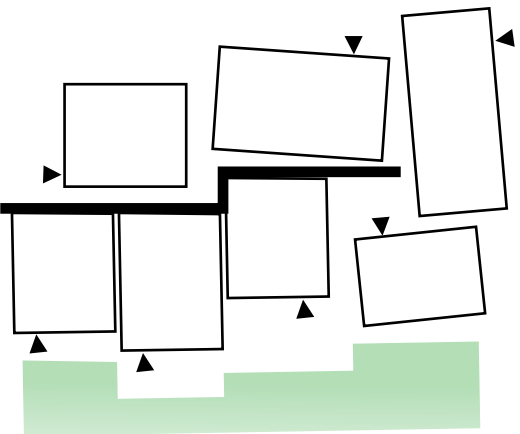
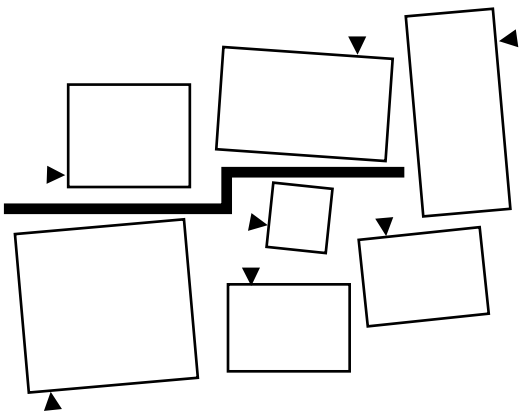
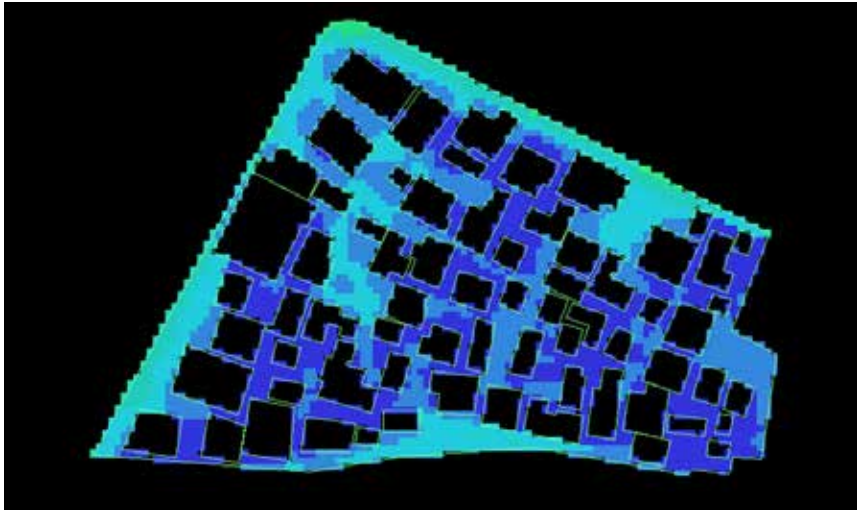

Bottom-Up Rules; Main street:

Through intergration of a hierachy of roads the plan will have a clear seperation between public and more private spaces.



The hierachy is made through a main plaza in the center of the new BT section leading up to the schoolyard on the oppisite side of the road.

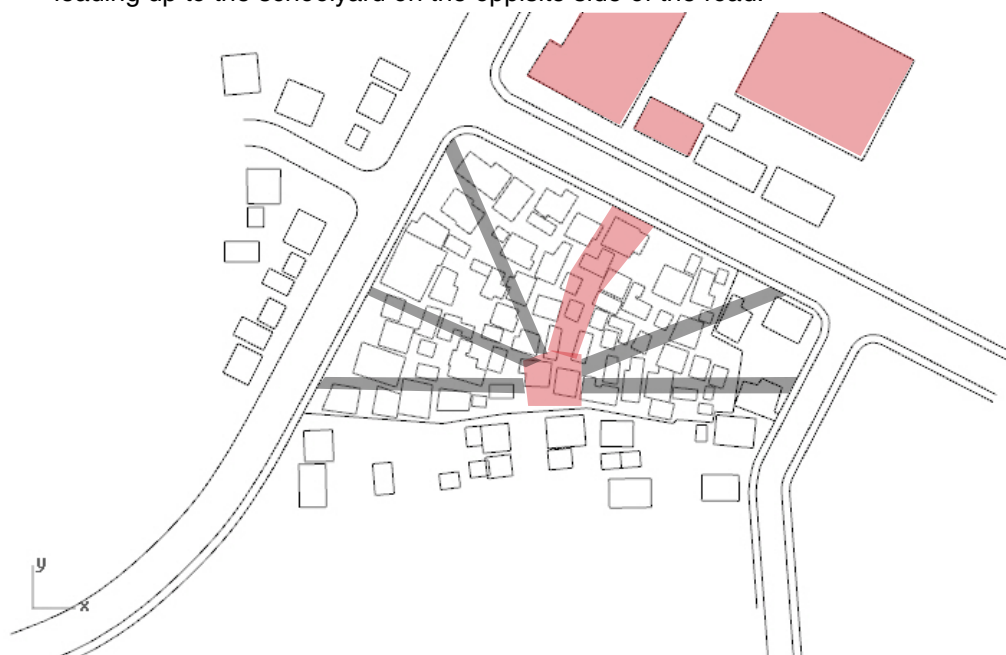

Grasshopper; Self Organizing Through Backbone.

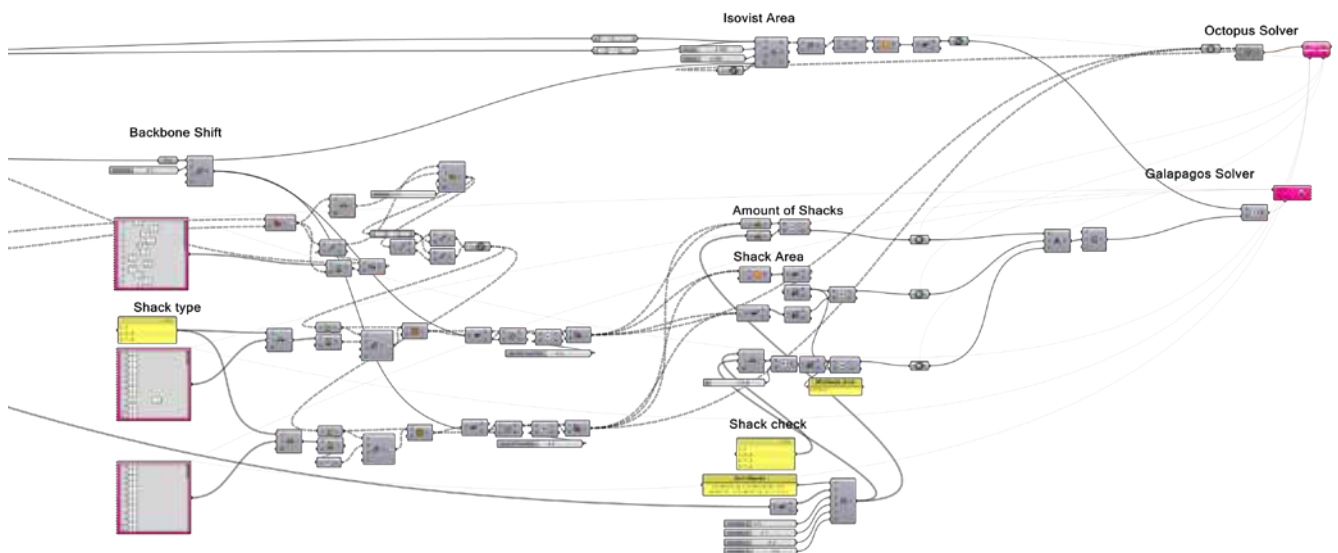
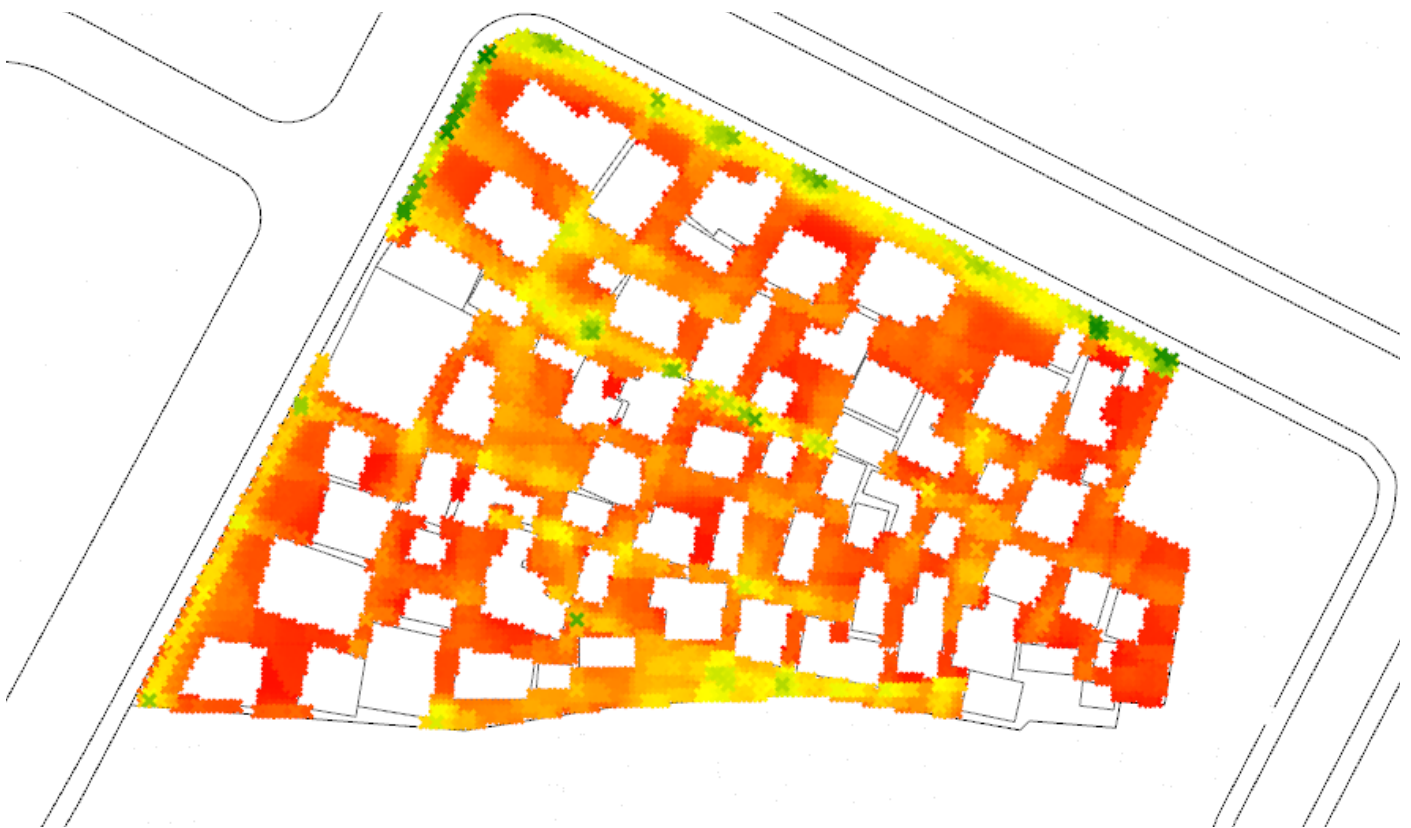
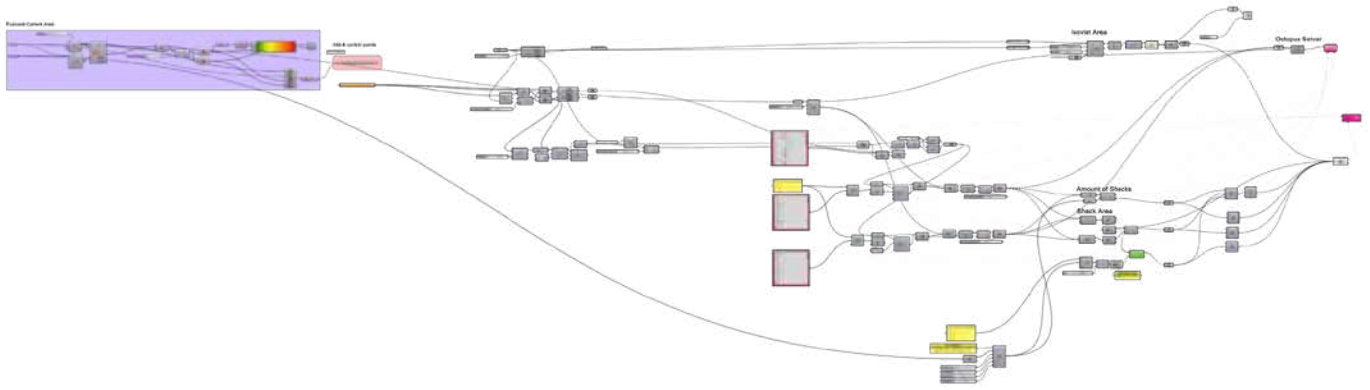

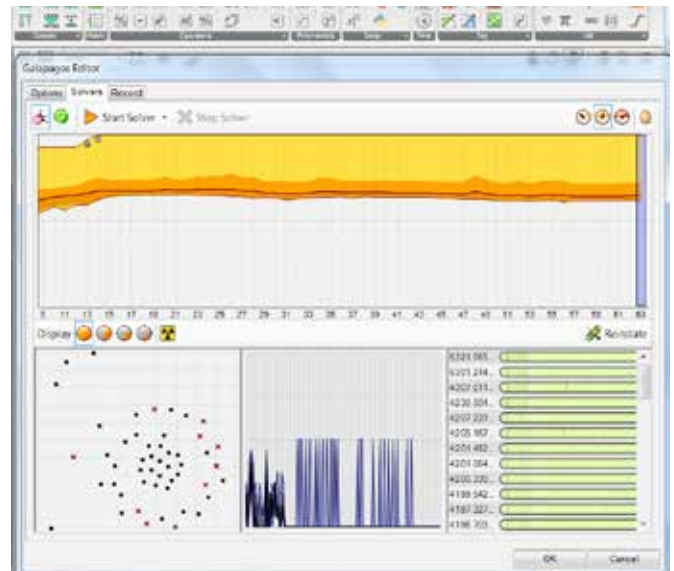
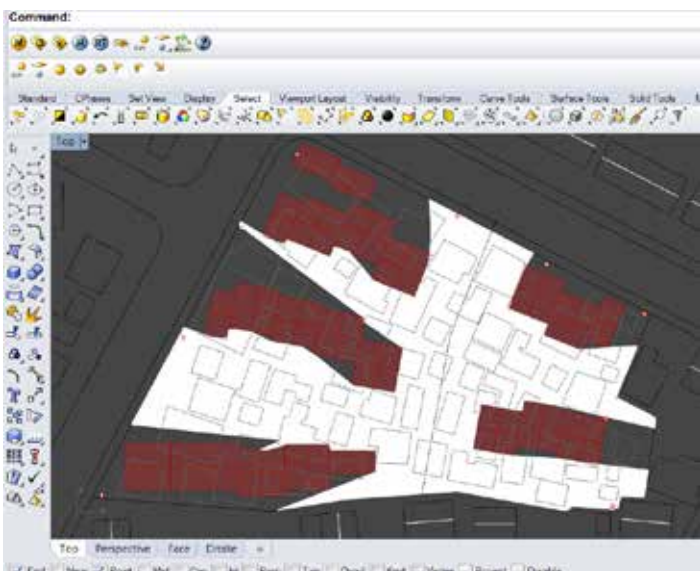

Conclusion

Grasshopper; Outset of solver and in combination with human logic manipulation.

After the use of the solver the effect of a more clear street is already quite visible. Because of this starting point it is now very easy for the BT community to understand why it is important to abide by the rules set and can see what impact it has visually.

Now any further negotiation will have a result that has a core design strategy imbedded in its genes. It will not stray very far from the preposed result because the clarity of its effects are very visible.

The effect created was very much related to the rules set and the idea that a main square would have a big effect on clarity in the plan. I don't believe that the use of systems like these can ever be self-reliant and will always need human input to create the most logical system. I found it interesting nevertheless to see if a program could help.

The idea was successful for me, because the effects of general ideas could be confirmed. Also using the program can help to design larger areas on a fast pace. On the scale of the BT section it seems a bit redundant because one can come to the same conclusions by hand drawing.

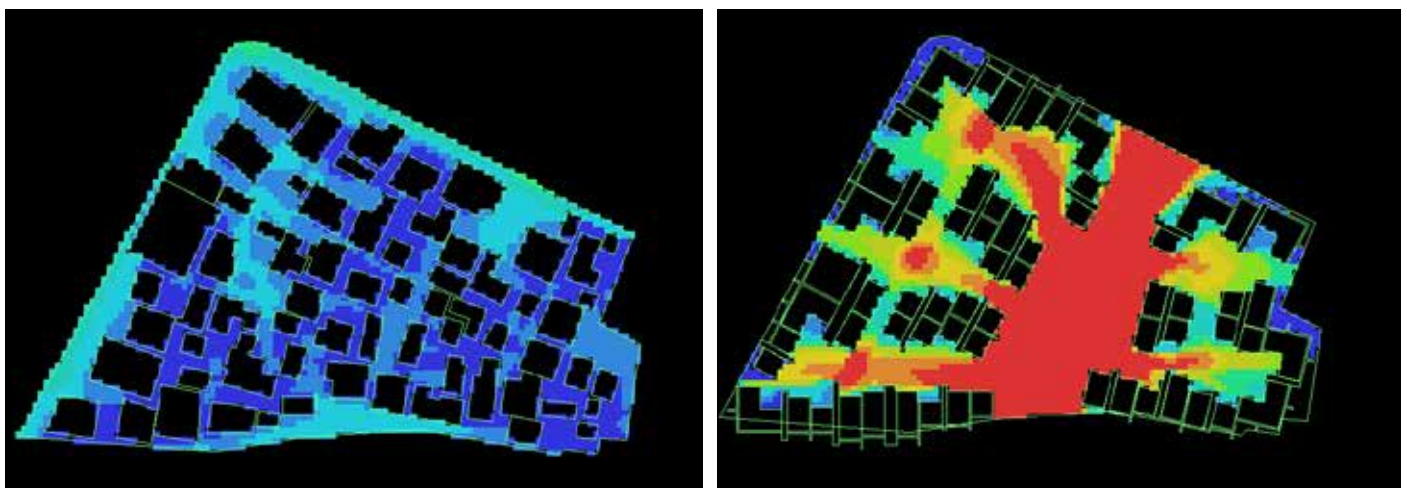



Design Criteria; Urban Gardening

From this starting point I looked at the effect of the new urban plan its relation to urban farming. As at the other side of the road, shown in green, a urban farm is being developed I did not feel it was necessary to use the plot we were investigating as a urban farming site. What I did find interesting was to see if after all of the calculations and negotiations potential area was still available for the use of urban farming.



New City District - Zürich Nord

Student: Zlatina Paneva

Summary of the project:

The theme of the project is called "Schaffhauserstrasse". This is the main and historic road, which connects Zürich with Kloten. However, the growth of the city of Zürich nowadays is integrating the street more and more into the urban context and this poses one fundamental question – how to translate the form of the country road into a form of a main urban street?

Additionally, this context is defined by two main particularities of high importance – the railway runs parallel to Schaffhauserstrasse and in this way it divides the context and isolates the road, and secondly, there is a new city artery built parallel to Schaffhauserstrasse on the other side of the railway. This is Thurgauerstrasse and it shifts the focus out of Schaffhauserstrasse.

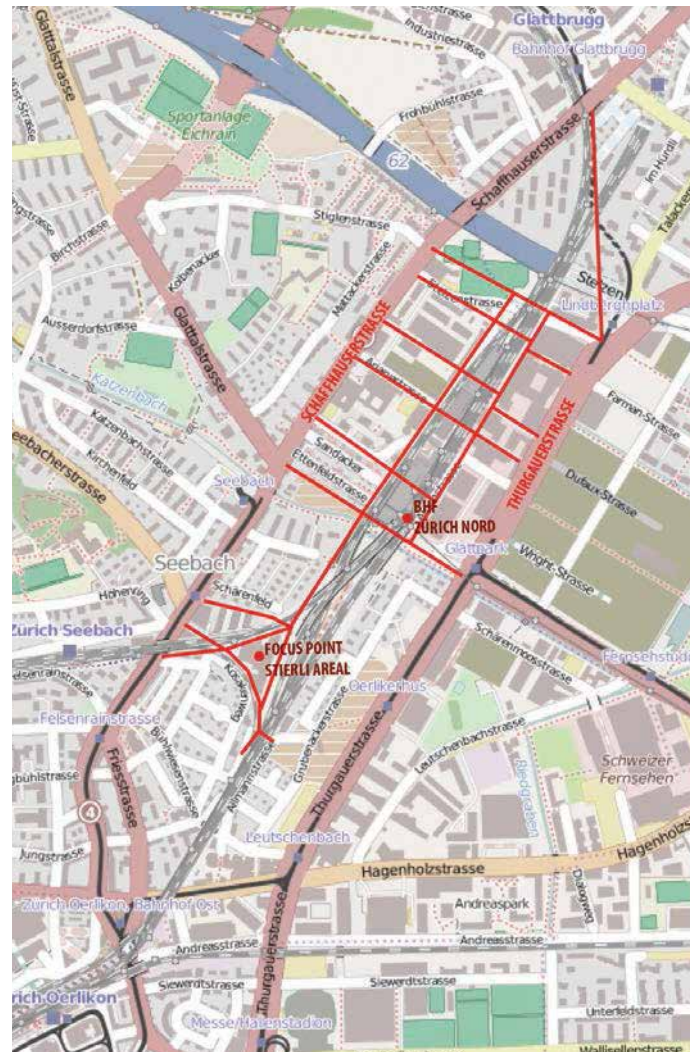
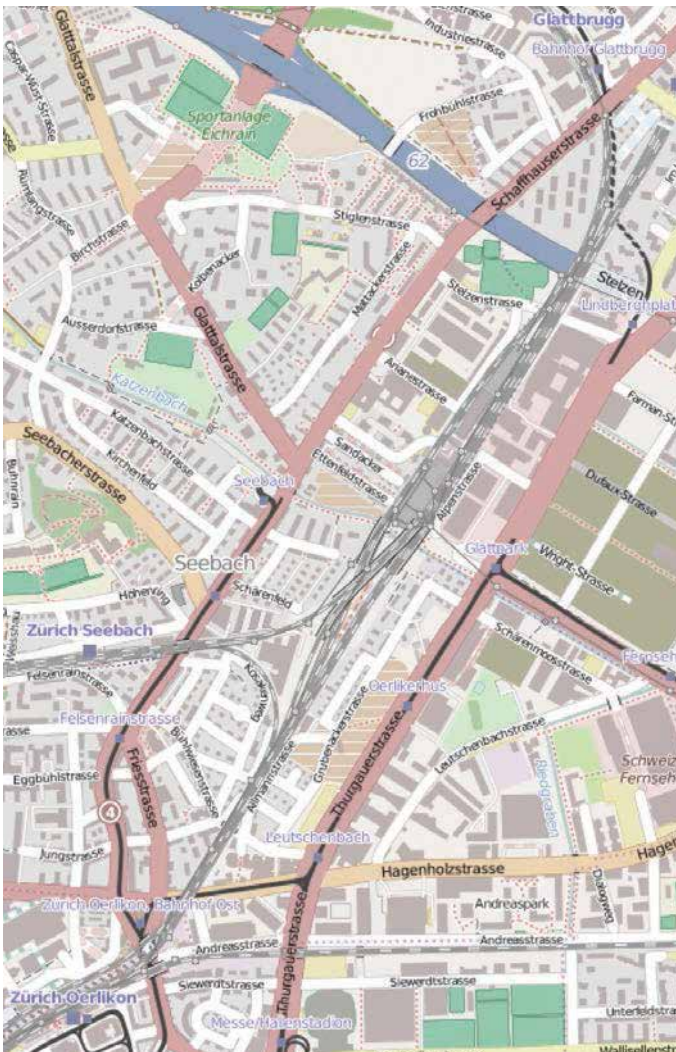
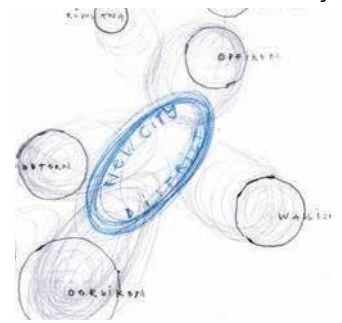
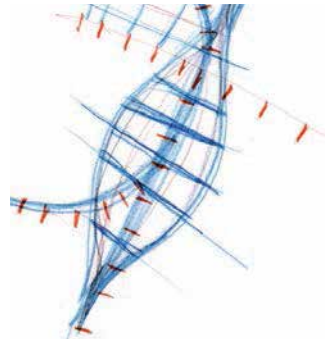

Motivation for the analysis:

The motivation for this analysis is the urban-planning nature of the project. It envisions a new street system and tends to transform the area through modifying the infrastructure and the open public space. The tools given for this analysis, namely Depth Map and Ecotect seem very appropriate to test the concept of the project because they are tools measuring the space syntax and urban micro-climate. points on Schaffhauserstrasse and activate them as part of the new network system. In this analysis as focus point is shown Stierli Areal (see summary), because as an old industrial building it has potential to become a centre for creative industry. This requires integration in the public space, which means good connectivity, and visibility. The approach includes three main steps: 1. Design a new train station in the middle of the defined plot and prove this spot as the most central in any of terms of the space syntax; 2. Lay a grid of new streets that connect the two isolated from each other main streets and prove the new system as affirming the concept of creating a new centre in the middle; 3. Focus on particular existing

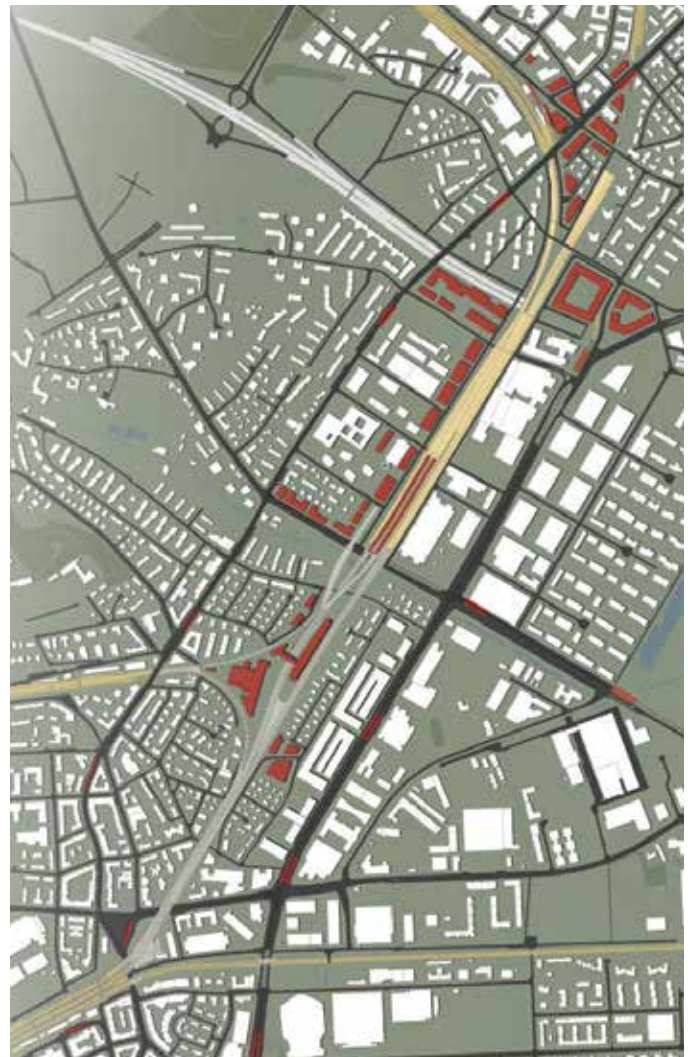
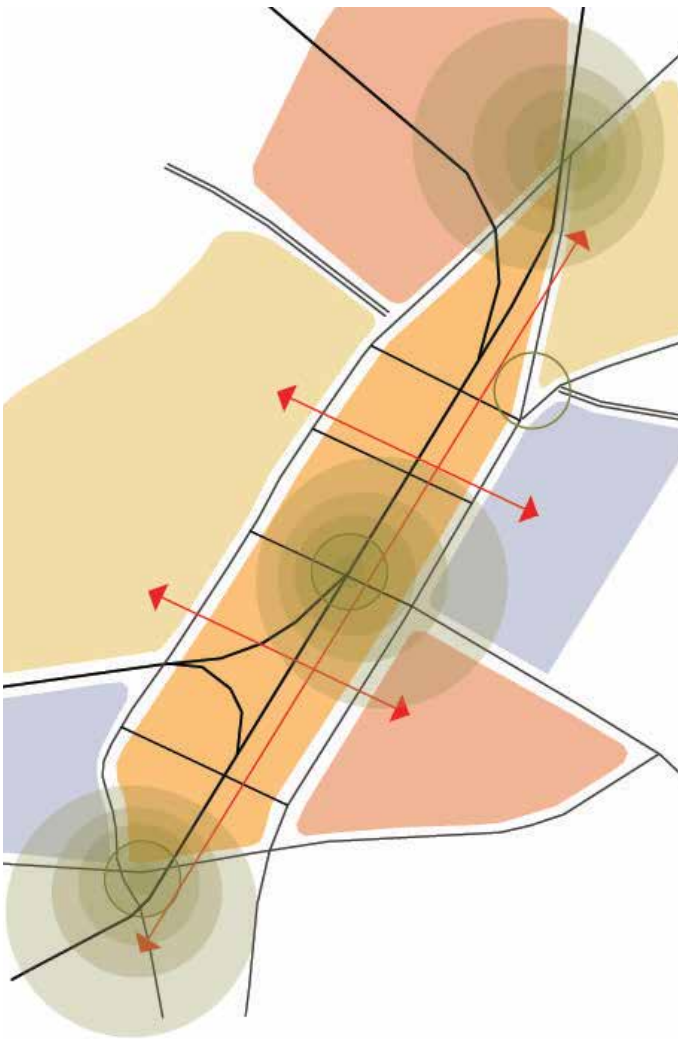

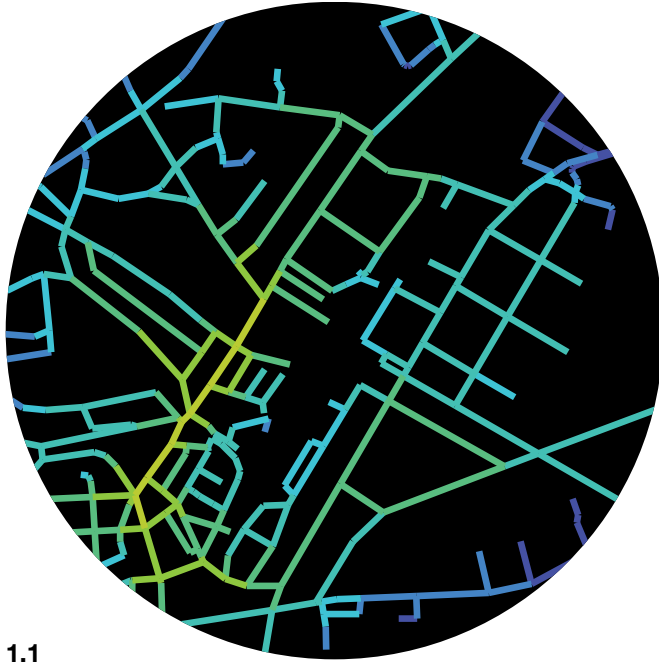

1.1



1.2

Integration is a key word for the project. This is why the analysis begins exactly with it. Fundamental for the new city district is to be integrated into the city of Zürich. The graphs analyze the integration of the streets in radius of 1km from the center of the plot, which is also the planned train station (for reference see the summary of the project). The first graph (1.1) analyzes the existing situation. It shows that the further from the center Oerlikon in Schaffhauserstrasse goes, the less integrated it becomes. Its gradual disintegration expresses its status quo of a street on the boundary between urban and out of the city. Further on this graph could be read that Thurgauerstrasse has the same aspect of gradual disintegration. Another important interpretation would be that there is low integration of the network between the two named streets and thus, they are also not integrated into one system. They function rather autonomously where Schaffhauserstrasse is slightly more integrated to the city than Thurgauerstrasse, because it has more ramifications in the proximity of Oerlikon.

The second graph (1.2) analyzes the situation after the changes that the project proposes. These changes are a critical answer to the analyzed existing context. The new street grid integrates Schaffhauserstrasse and Thurgauerstrasse into one system and makes one mostly integrated crossroad exactly in the middle. Nevertheless, this is the position of the new train station. The two streets are no more autonomously functioning, but integrated into one entity. Schaffhauserstrasse remains slightly more integrated than Thurgauerstrasse, which is also coherent to the history. Through this intervention the integration of the two arteries is no more vanishing in the non-urban, and they are rather transformed into one integrated to the city centrality.

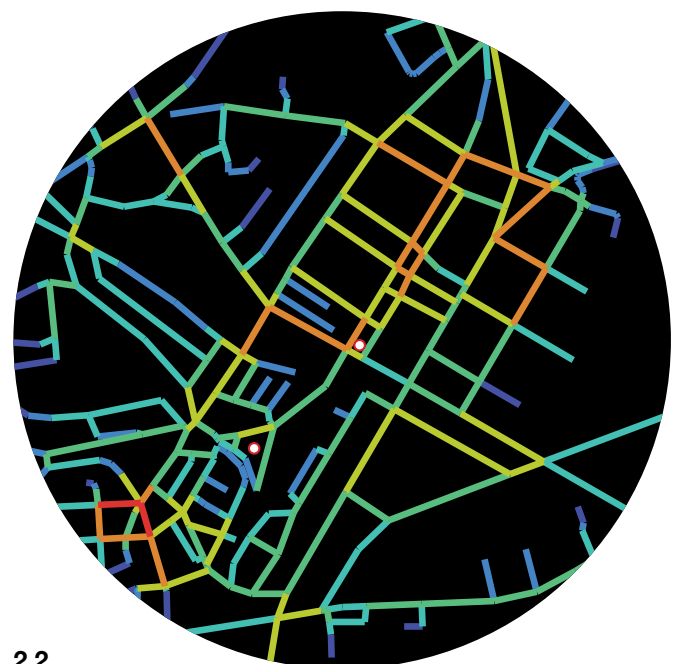
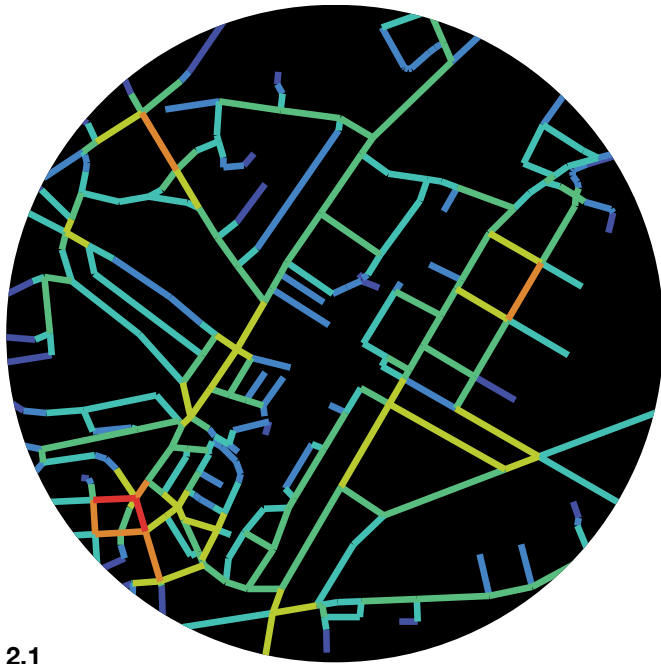

Connectivity is another important term for the project. “Urban” is in a way a synonym of “connected” and in this sense it is fundamental to establish the connectivity values of the existing situation in order to be able to set a new and appropriate level of connectivity values for the new city district. Identically to Analysis 1, the first graph (2.1) analyzes the existing situation. In contrast to the integration values, the connectivity keeps quite a constant value, however the increase of the distance from the center Oerlikon. This could be explained with the fact, that after leaving the centrality of Oerlikon, the streets are quite homogeneously loaded within their suburban context. There is even slightly increased connectivity in the middle of the analyzed part of the streets. It shows that in this part our two main arteries are better connected to the context behind them and they have a higher depth there. This is a sign for a little centrality at that point. Interestingly, in reality these two points are two centers of the two neighborhoods in that part of the street.

The second graph (2.2) regards the situation after the changes that the project proposes. Here the changes are intended to reaffirm the existing connectivity and to increase its values. This is why the new grid is thought and to be read as extension and rationalization of the existing network in the area of the perimeter between Schaffhauserstrasse and Thurgauerstrasse. Sometimes there are some shifts of the extensions, because the existing buildings do not allow linearity. However, the connectivity is drastically increased. Not only the middle piece has become a well-connected city district, but also our two main streets have punctually increased their connectivity at the main crossroads. Again, the position of the new train station proves to be appropriate, as it lay on a spot with the highest value of connectivity.



3.1

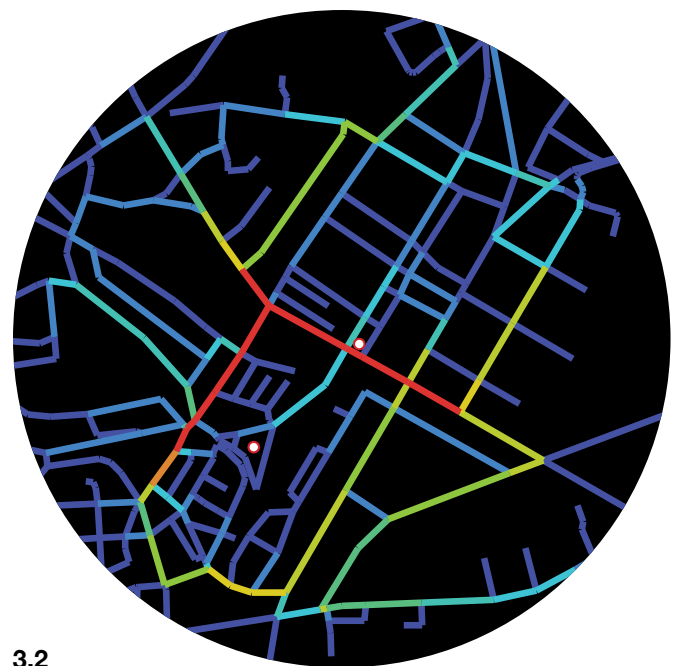

3.2

Choice is a term, which did not have influence on the design process of the street network, but is defining for the functions within the buildings and their size. This analysis shows the most preferred arteries and helps define the spots that are the most appropriate for frequently visited public spaces and public functions.

Here the first graph (3.1) analyzes the existing situation as well. It shows that the most "chosen" artery is Schaffhauserstrasse in its proximity to Oerlikon and its south connection to Thurgauerstrasse. This reflects the reality, in this part there are many public functions on the ground floor and the street is quite busy with pedestrians and cars. The second most "chosen" street is the other connection between Schaffhauserstrasse and Thurgauerstrasse, which is also logical, as it is the only way to go across in the north part. In reality there are not many public buildings to be found there, but this connection is quite often used for the transport.

The second graph (3.2) regards the situation after the changes that the project proposes. These are consciously thought to provoke the highest choice in the new middle and central connection between Schaffhauserstrasse and Thurgauerstrasse, where also the train station is. Luckily (because we want to stay coherent to the history) Schaffhauserstrasse has kept its high choice values and thus there is created one very intensively used crossroad. The project does take this potential into account and envisions a public park as connection with a square right next to the crossroad. Additionally, it is also envisioned to raise the existing buildings with two floors along the connection (see plan and picture left). This graph proves the intentions of the design to be appropriate. It also reaffirms the shift of the center from the proximity of Oerlikon and it's vanishing with the increase of the radius to the hearth new city district.



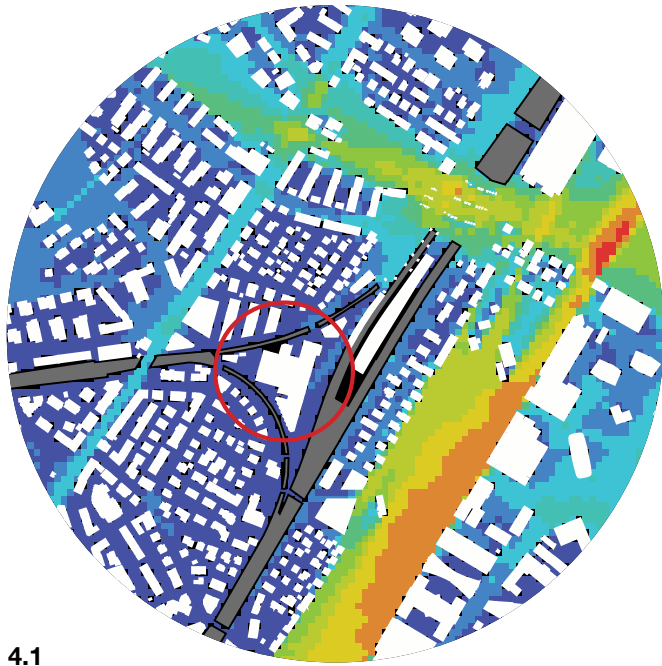

4.1

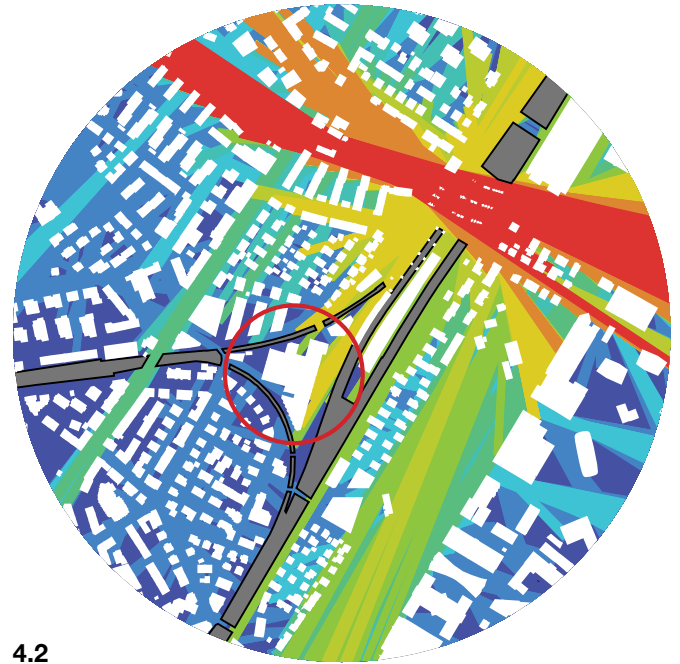

4.2

Focus Point "Stierli Areal"

(Circle within the radius of 500m out of it) Along with the new network system, the design process envisions a "zoom-in" on some important existing points on the Schaffhauserstrasse. These are singular projects within the master plan, which have the function to additionally activate the Schaffhauserstrasse, and to take advantage of and increase its existing potentials.

Stierli Areal is defined as one such focus point. It is an old industrial building, which nowadays lives from the aura of its patina. It is transformed into a place for creative industry, but it somehow remains isolated from the urban tissue. This is owed to a great degree to the railway, which cuts it out from the urban tissue. In this plan the railway is drawn as a grey volume (see graphs) because in reality it blocks the views and there are rarely connections under it (see section and picture left). The design goal is to put Stierli Areal in focus within the urban tissue and make out of it a central building. The aim is approached through the establishment of new connections under and above the railway.

These connections are supposed firstly to increase the visibility of the project and thus make it destination for the fluxes around. In order to examine if they fulfill their purpose there is an overall isovist analysis shown on graph (4.1). The entrance from the new train station is quite visible, but the other ones remain quite invisible. This analysis implies that the connections should be better studied and not being blocked by a building in front of them, which is the case on several points. They should be more centrally placed and more directly connected to the main arteries. Another strategy for the increasing the visibility is to place a tower next to the existing building. This intervention is however not included into the isovist analysis, because this isovist is supposed to analyze the visibility of the connections leading to the project.

The second graph (4.2) is an all axes analysis of the connectivity of the project. It is made in order to examine if the axial connections are dependent on the visibility. The results point that the connectivity has higher values than the visibility, which speaks for independence between the two factors (visibility and connectivity). A possible interpretation of this comparison is that the building is well connected, but as it is badly visible, it remains connected only to the social groups that already know about it. It is not a place, which would be accidentally visited.

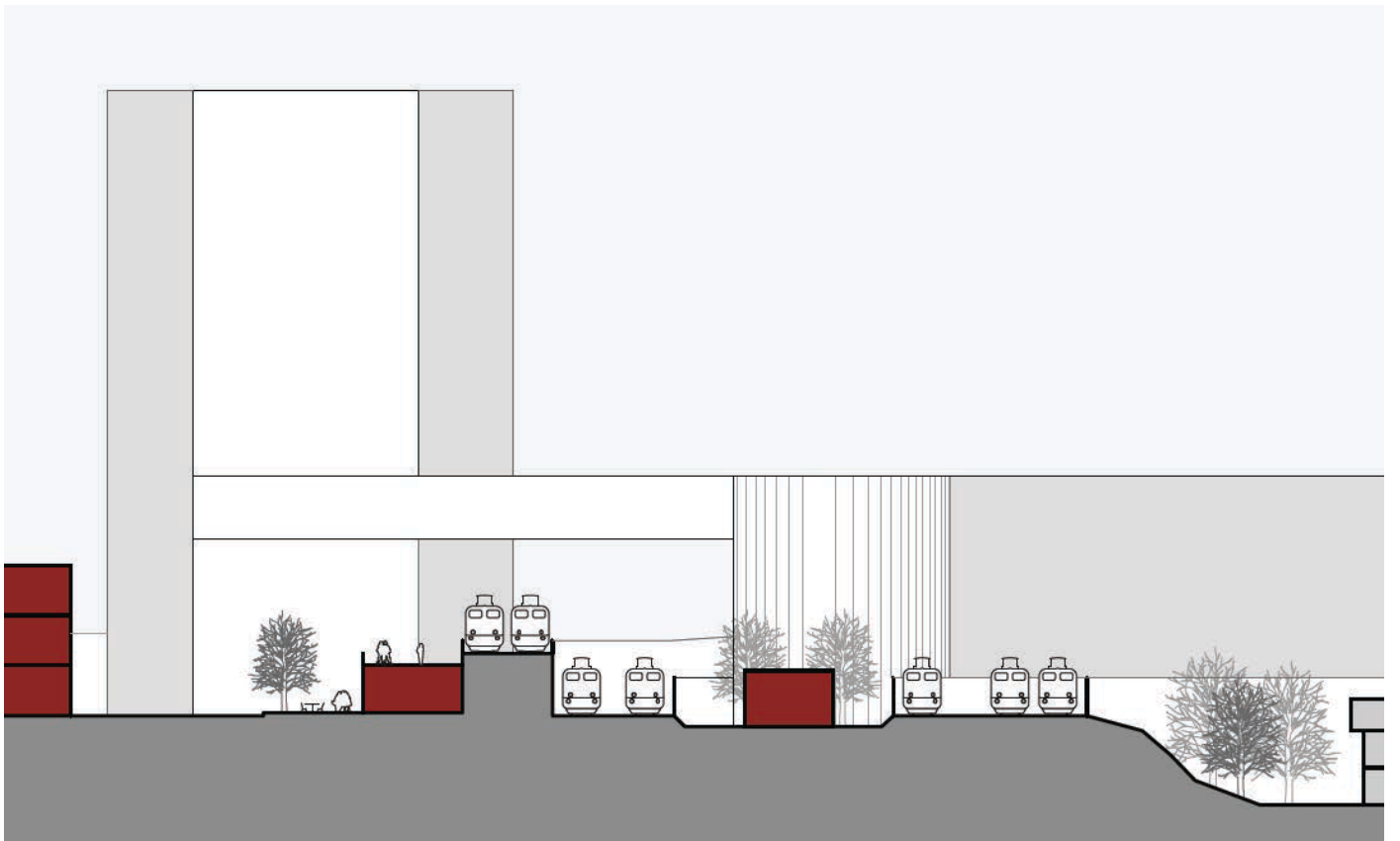

Analysis 5 (Ecotect- Shadowrange Analysis):

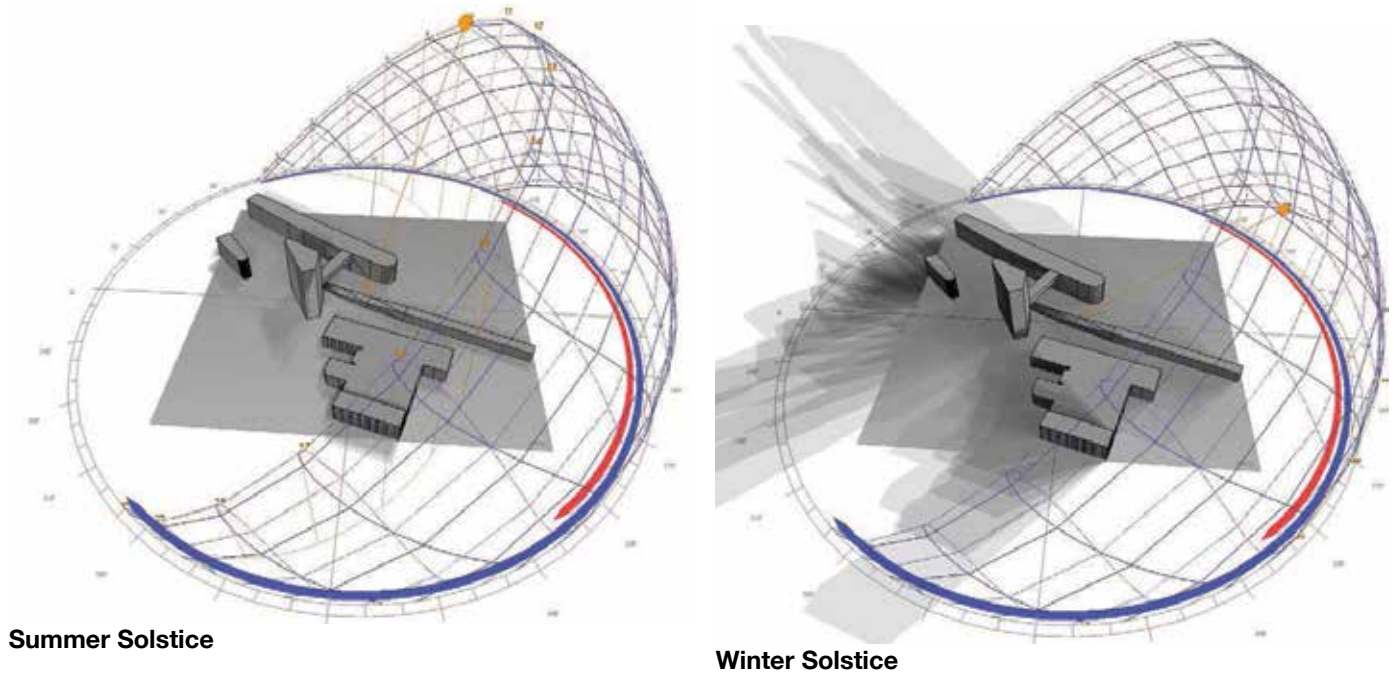

Focus Point "Stierli Areal"

Analysis 5 has the aim to analyze if the planned tower in immediate proximity to the old existing building would have negative consequences, as for example throwing a constant shadow on it. The analysis is run for the period of the summer and the winter solstice, because those are the two periods when the sun is respectively highest or lowest positioned in relation to the earth. As visible on the graphs, the shadow during the day of the summer solstice is short and remains near the tower, whereas during the winter solstice the shadow is long and has the biggest area. However, in both cases the opportune position of the tower, namely in north from the existing building, contributes to a very favorable situation - the shadow of the tower is practically never falling on the existing building. This proves that the placing of a building with extraordinary height in such proximity is possible and not harmful for the microclimate of the existing urban context.

Conclusions:

Using analysis software is a good practice for an accurate and precise test of the own design. Simulating design decisions before realizing them is important for the thorough comprehension of the complex entity of any situation, for preventing unexpected problems, for being more conscious. Additionally, an analysis gives implications for design, that are not always so obvious and thus helps finding the best solution. Computer-simulated analysis is absolutely positive.





iA

DARCH