



Software Group

Projektansätze mit IBM Portalserver

Dr.-Ing. Horst Henn
IBM Deutschland Entwicklung GmbH
IBM Software Group
hhenn@de.ibm.com

IBM Portal Entwicklung

IBM WebSphere Portal - Microsoft Internet Explorer

Address: http://wps61.boeblingen.de.ibm.com/wps/myportal/!ut/p/_s_7_0_A/7_0_6Q/.cmd/ad/_ar/sa.spf_ActionListener.c/6_0_46/ce/7_0_83H/p/5_0_7JQ/d/0?PC_7_0_83H_spf_strutsAction=%212fdisplayMessageHeaders.do%213fserverGroup%3Dnew: Go

Welcome Horst Henn! My Portal ? Log





Applications Collaboration Center Documents Our Customers My Work AP EMEA US My Favorites

News Portal Documentation WebSphere Portal Development WebSphere Portal Public APIs WMM5.1

Information Portal v5

Welcome to **Portal Portal**.
This is the **portal** for WebSphere **Portal** Developers. Use your IBM Intranet user ID and password for access. **Note:** To enable your IBM Intranet user ID and password, use the registration portlet on this page. If you have any feedback comments, please send them to [Wolfgang Sieber](#).

Boeblingen Haifa Raleigh Sydney Westford

Patty's news menu

News groups

Select a different newsgroup

ibm.software.websphere.portal-server

Subject	Posted by	Last post	Replies
how can i do this?	jjd228@NOSPA...	9/13/04	1
struts & messaging portlets	mantis713@co...	9/11/04	0
2 Portals: WSRP Portlet doesn't work	Tino Drohula	9/10/04	0
Themes	gaurav99	9/9/04	2
PortletModes	Christian Peder...	9/8/04	0
Aqain: 20.000 users in LDAP a problem?	Silvain Piree	9/13/04	3
Lotus Workplace 2.0 install	Jon Mell	9/6/04	0
about lwcm's setup question	wps_zk	9/6/04	0
Authorization for user wpsadmin failed	Chemi	9/6/04	5
get Family Name	Vasil Yaroshevich	9/3/04	0

1 - 10

Patty's news content

Patty's initial link

World Clock

Local Time:
5:48 PM Brussels, Berlin, Bern - 9/14/04

Time Zone	Local Time
Pacific Time (US & Canada)	8:48 AM (9/14/04)
Mountain Time (US & Canada)	9:48 AM (9/14/04)
Central Time (US & Canada)	10:48 AM (9/14/04)
Eastern Time (US & Canada)	11:48 AM (9/14/04)
Brussels, Berlin, Bern	5:48 PM (9/14/04)
Israel	6:48 PM (9/14/04)
Canberra, Melbourne, Sydney	1:48 AM (9/15/04)

Quick Search:

RegisterIntranetUser portlet

About WebSphere Portal

ClusteringDemo portlet

Boeblingen entwickelt den Portal Kern (Vorentwicklung seit 1997)

Ökosystem für Bibliotheken

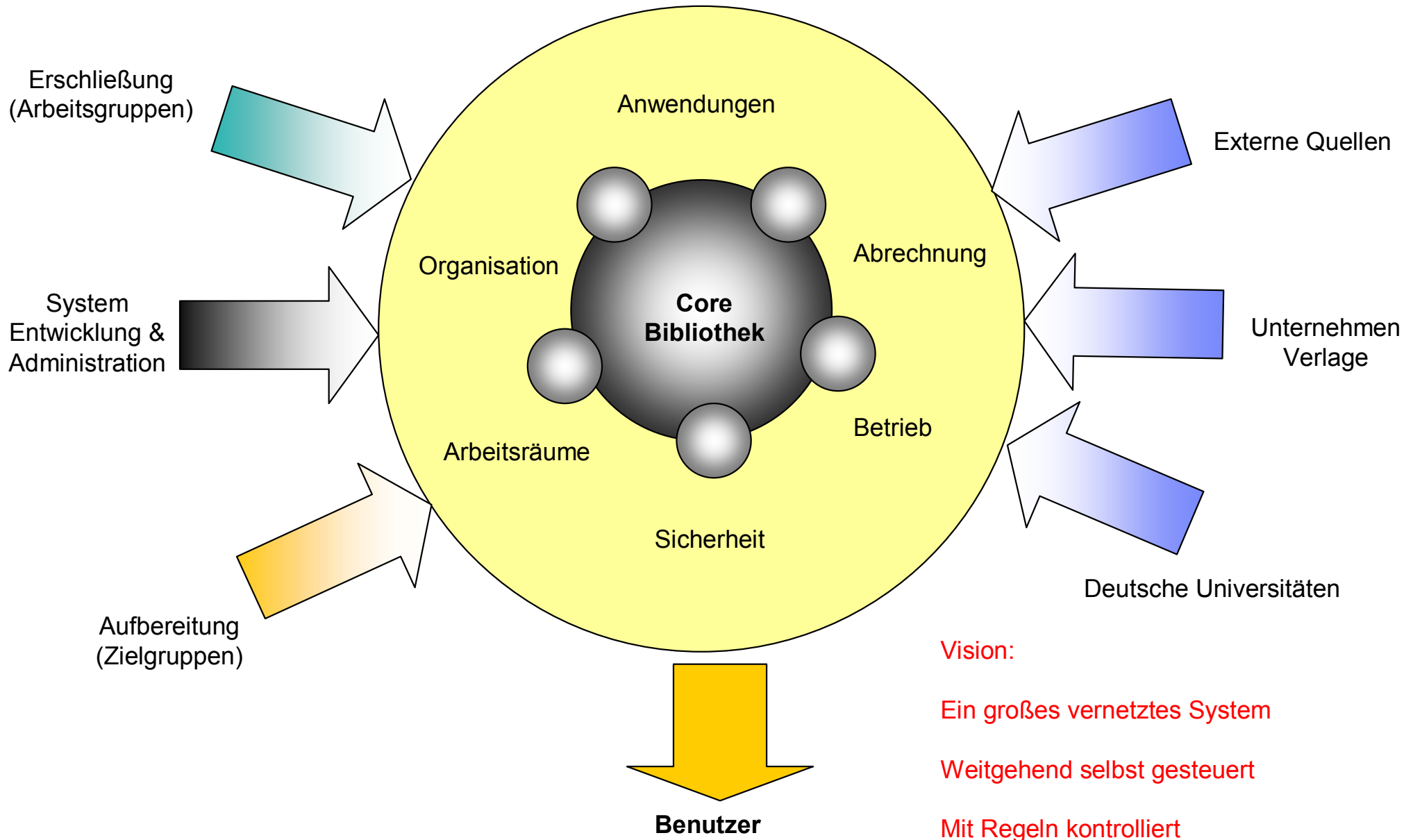

Portals Integrationsplattform

The screenshot shows the IBM w3 portal interface. At the top, there's a navigation bar with 'w3 home', 'BluePages', 'HelpNow', and 'Feedback'. Below that, there are tabs for 'Work' and 'Career and life'. The main content area is divided into several sections:

- Essential links:** A list of links including 'About IBM', 'Automotive Industry', 'Collaboration Central', etc.
- News:** A section titled 'Top stories Past 7 days >' featuring articles like 'U.S. Department of Defense taps IBM for RFID rollout', 'A record week for w3', 'What a Fair Market Value Lease is -- and why you should know', 'A day in the life of Bob Blakley', 'Competitive alert: Microsoft products slip', and 'WebSphere Business Integration makes a splash'.
- Search:** A search box with options for 'Name only' and 'Entire profile', and a 'GO' button.
- BluePages:** A section for searching profiles, with a 'GO' button.
- Other searches:** A list of search categories like 'w3 intranet', 'ibm.com Internet', etc.
- Market report:** A table showing stock market data for various symbols like IBM, DT, MSFT, SUNW, and VRSN.

Red arrows point from the text 'Personalisierung' to the 'U.S. Department of Defense taps IBM for RFID rollout' and 'Competitive alert: Microsoft products slip' articles.

Personalisierung

- Portlet
- Standardisierte Funktion
 - Anzeige
 - (Back End)
 - Web Service (WSRP)

Browser basierender Zugriff auf > 10 00 verschiedene Systeme

Portal Server - Plattform für IBM und OEM Produkte

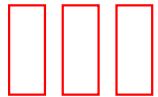

z.B. DB2 CM
Portlets

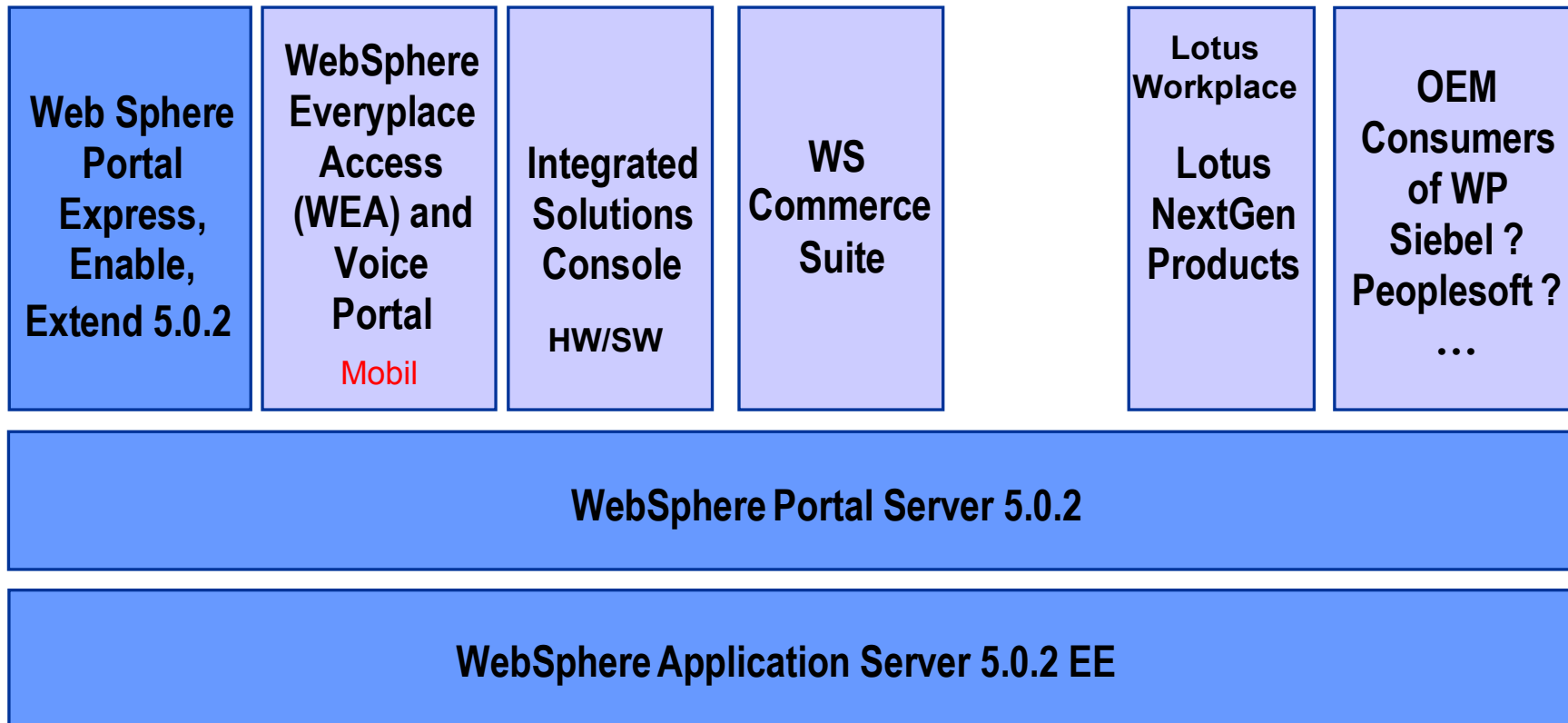

Strategische Plattform für IBM HW & SW Produkte

Heute Informations Portale - Redaktionssysteme

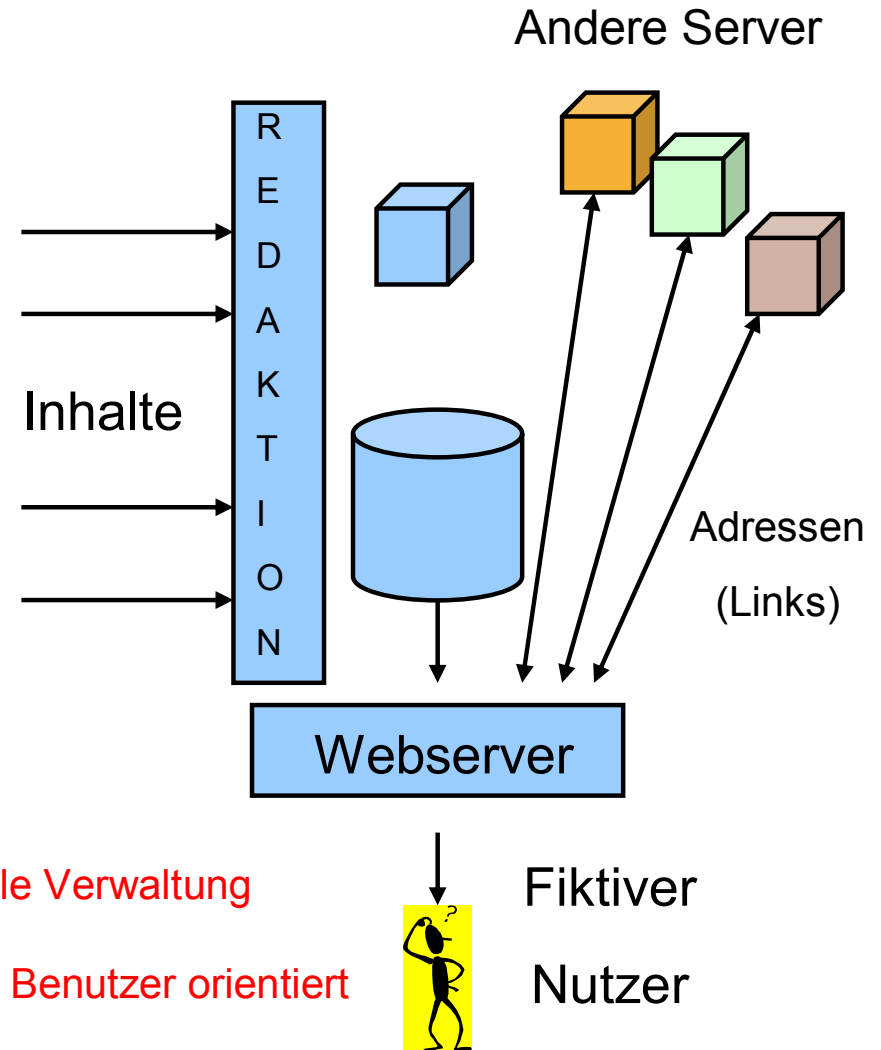

Informationsflut, lange Suchzeiten, komplexe Lösungswege - Ineffizienz

On Demand Workplace

IBM
w3 home | BluePages | HelpNow | Feedback

Home | Work | Career and life

Essential links

- About IBM
- About w3
- Automotive Industry
- Collaboration Central
- Customer Reference Materials
- Globalization Central
- Healthcare & Life Sciences Industry
- IBM Global Campus
- IBM On Demand Community
- IBM SiteServ
- IBM Standard Software Installer
- IBM Travel
- Learning Navigator
- Media & Entertainment Industry
- Presentation Central
- Retail Banking Industry
- Sam's w3 pages
- Software Group Intranet
- Speak Up Program
- Telecommunications Industry
- Google
- Horst Privat
- Labor Boeblingen

News

Top stories Past 7 days >

Performance & Pay
Performance metrics for first quarter 2004

Making a world of difference
More than 13,000 employees from over 55 countries are registered with On Demand Community. Find out what your colleagues are doing, and how you can get involved.

Anatomy of an on demand business
No single component can establish an on demand business. Today, IBM introduces new software and services to help companies develop and deploy Service Oriented Architectures. [Software Group]

Alert: Protect IBM from mass mail worms
Run LiveUpdate and scan your workstation [Transforming IBM]

Talk with Steve
How does SWG secure funding for acquisitions? [Software Group]

Uncle Sam wants YOU to comply
IBM offerings help to address government compliance concerns [Americas]

Search

BluePages

- Name only (smith, jo*)
- Entire profile ("grid computing")

Other searches

- w3 intranet
- ibm.com Internet
- IBM news articles
- IBM discussion forums
- Software
- uPortal

Market report

Quoted at 2:04 PM, EDT on 21 Apr. Refresh

Symbol	Current	+/-
IBM	91.08	+0.43
DT	17.20	-0.16
MSFT	25.38	+0.05
SUNW	4.19	+0.05
VRSN	15.83	+0.28

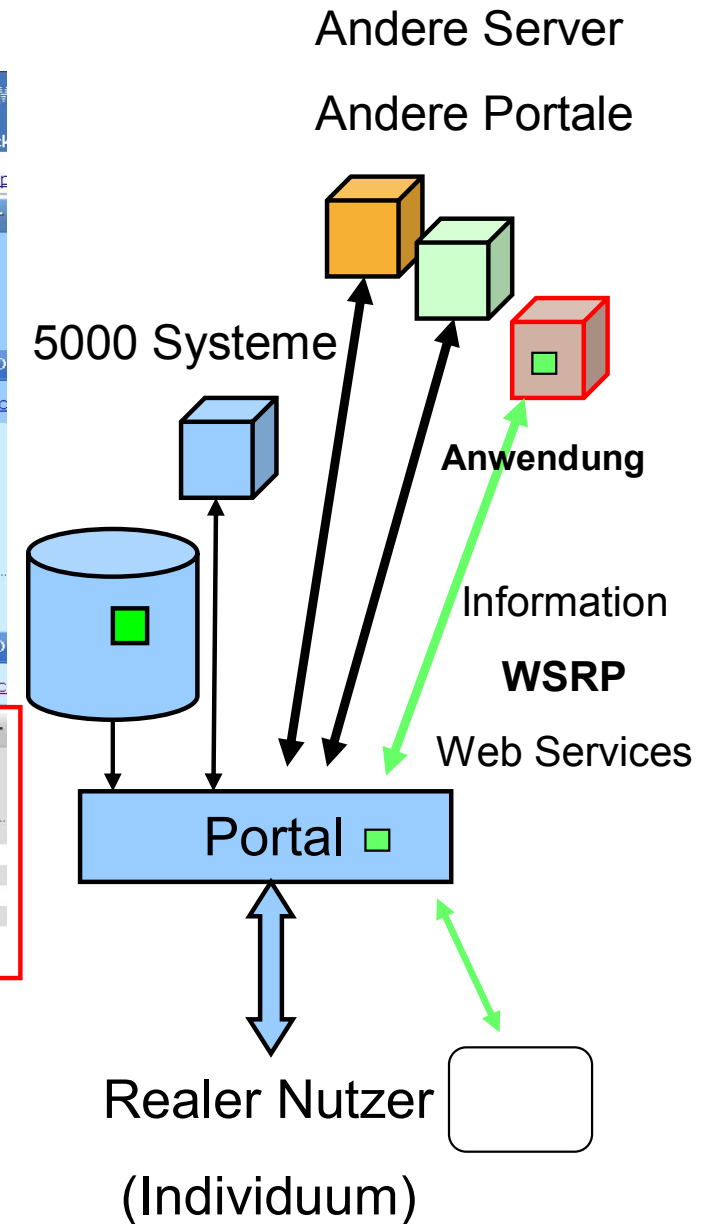

- Benutzer orientierter Zugriff
- Kooperation mit anderen Teilnehmern
- Aggregation von Diensten mehrerer Anbieter
- Inhalte auch von Benutzern + Selbstverwaltung

Beispiel: Workplace für Minijob Sachbearbeiter

The screenshot displays a workplace interface with the following components:

- Navigation Bar:** Welcome, Applications, Collaboration Center, Our Customers, My Work, AP, EMEA, US, Latest News, My Favorites.
- Minirente Reminder:** Monday, May 17, 2004. Tasks include: Minirente-Rechner ins Portal einbauen, and Formulare ins Portal einfügen und prüfen. **Erinnerung** (Reminder) is highlighted in red.
- QuickLinks:** Quick Browse section with a link for "Minijob Rechner Vertrag erstellen" and a "Go" button. **Links** is highlighted in red.
- Midi Job Beitragsrechner:** A calculator interface from "impulse" (www.impulse.de) titled "Sozialversicherung bei Midi-Jobs zwischen 400 und 800 Euro". It includes a search bar and navigation links. **Midi Job rechner** is highlighted in red.
- PDF Document Viewer:** Displays a document titled "Was sind Minijobs?". The text explains that the Social Security Code (Sozialgesetzbuch) recognizes three types of minijobs as of April 1, 2003: low-wage minijobs (geringfügig entlohnte Minijobs), short-term minijobs, and part-time minijobs. **Minijob Zentrale** is highlighted in red.
- IBM Internet Mail Box:** Includes buttons for "Check Mail", "Compose", and "Sign Off". The current account is "m36142657-6@pop.1und1.com". **Mail zu Minijobs** is highlighted in red.

Die neue Welt – Aggregation von Diensten im Web

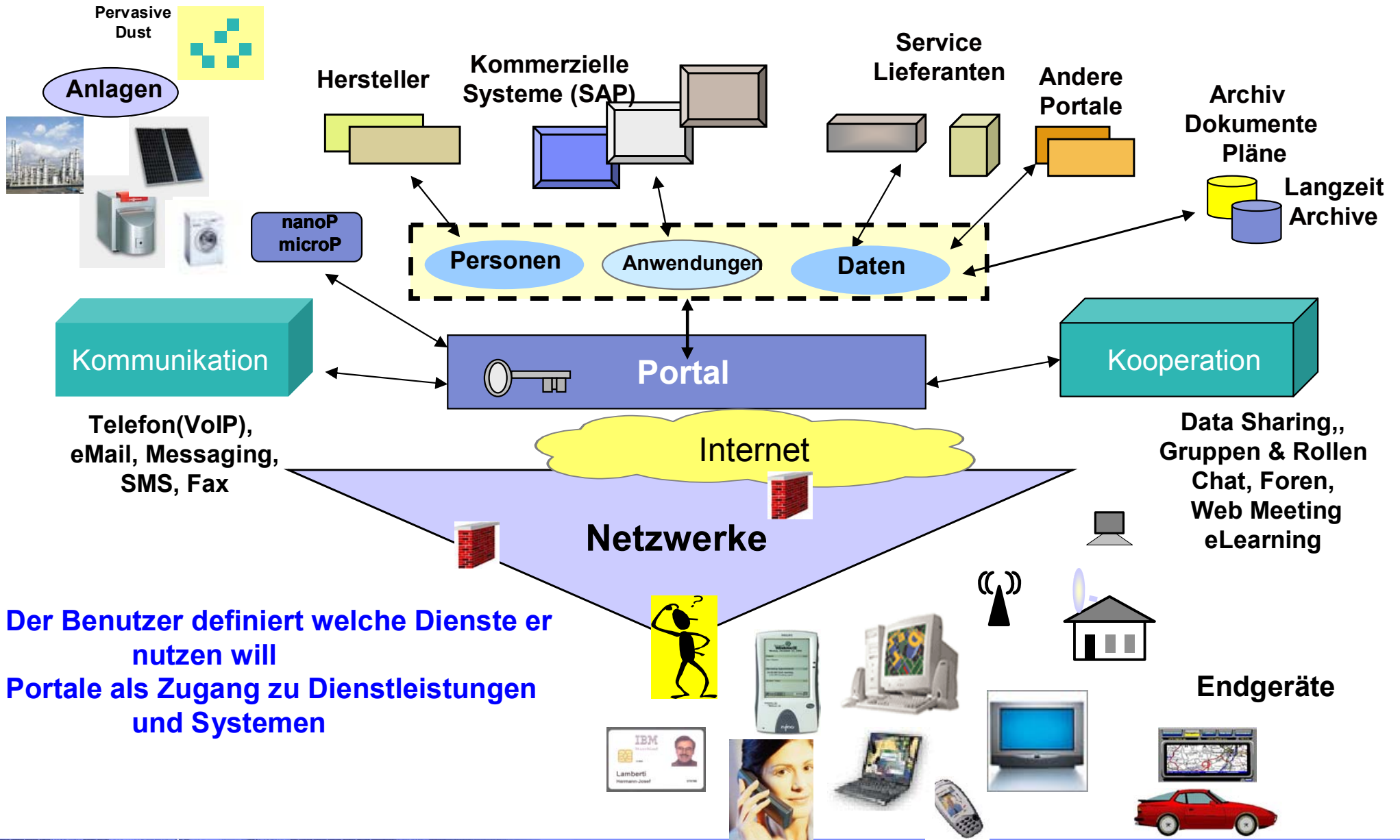

- Der Benutzer definiert welche Dienste er nutzen will
- Portale als Zugang zu Dienstleistungen und Systemen

Portal integriert und aggregiert auf mehreren Ebenen

Integration und Aggregation auf mehreren Ebenen:
 Benutzer, Geräte, Sicherheit, Präsentation, Business Objekte, Business Logik, Betrieb, Service, Backend Systeme und Prozesse

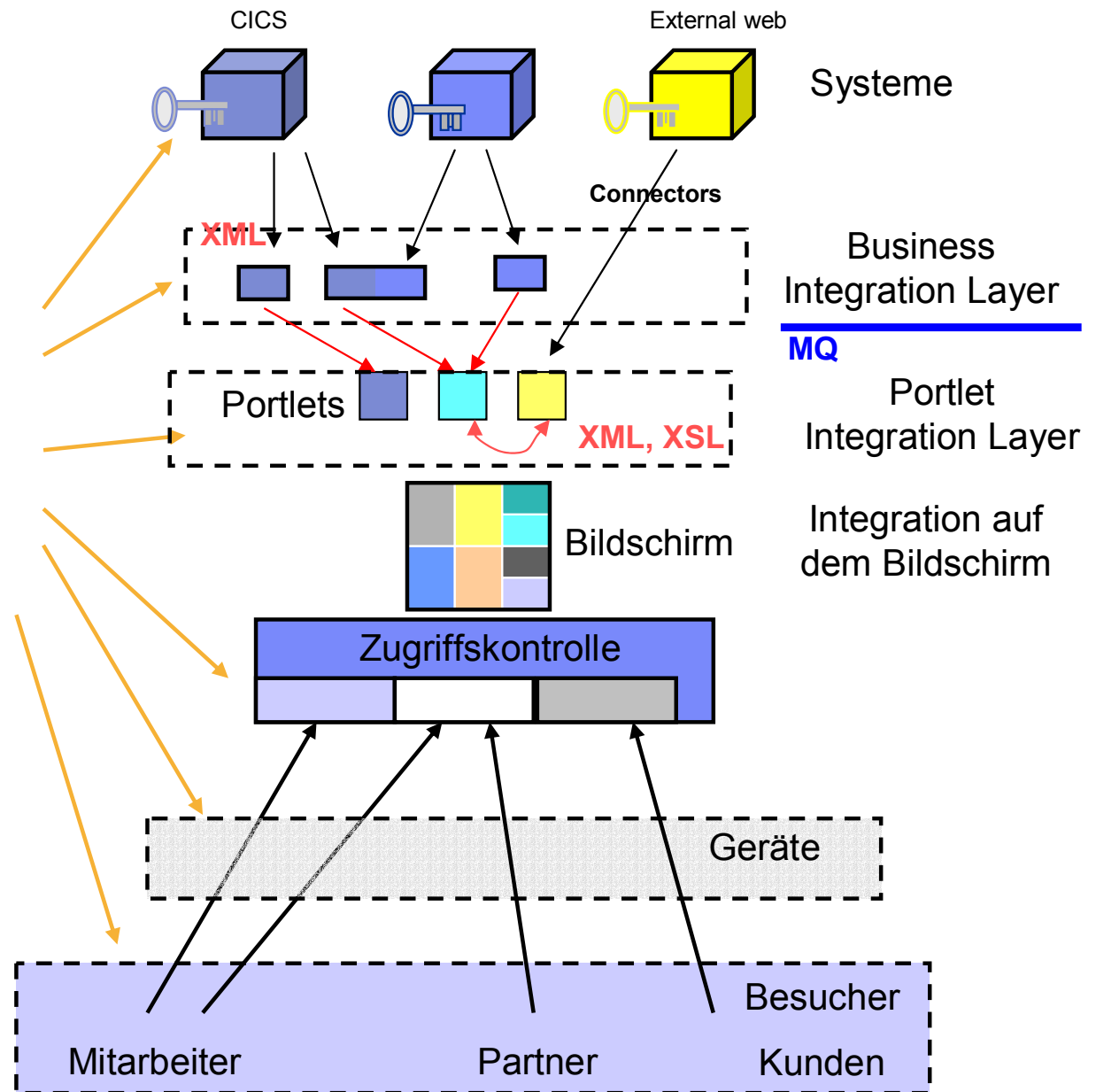

Co-operating Portlets

Weather

City Name: Atlanta

26 °C

Humidity 34

UV Index 7

Pollen Index 4

Wind 14 mph E

This information is illustrative and does not reflect current conditions.

Atlanta

Change City

Tourist Information

City Name - Atlanta

Description - . "Millions of Peaches"

The fact that there are 32 streets in Atlanta with the name "Peachtree" might lead you to believe this is an orchard! While that was once true, Atlanta has transformed itself into one of the leading lights of the south, culminating in the hosting of the Olympic Games in 1996.

The summers here are hot and humid, but it is springtime that brings the majority of visitors unused to that climate to Atlanta with attractive temperatures in the low twenties degrees Celsius, however the area does still experience thunderstorms and tornadoes are also a hazard. Autumn weather is more consistent, with warm, sunny, calm days. Mild winters round off the year, although snowstorms have been known to occur.

Click Map

Select a city from the map below

Selected City: Atlanta

Weather

Receive

Tourist Information

Send

Receive

Click Map

Send

Receive

Arrange the order that portlet links are processed:

Outgoing information (Source)	Incoming information (Target)
City Name (Tourist Information)	City Name (Weather)
City Name (Tourist Information)	City Name (Click Map)
List of Cities (Click Map)	List of Cities (Tourist Information)
City Name (Click Map)	City Name (Weather)
City Name (Click Map)	City Name (Tourist Information)

Portlet
Messaging
Drag & Drop

1) Portlet Entwickler kann portlets durch Portlet Messaging (JSR 168) verbinden

Portlet
XML Messaging

2) Automatische Cooperation: Administrator kann portlets so konfigurieren, dass Datenaustausch automatisch erfolgt (Click to Action)

Value chain and work flow support

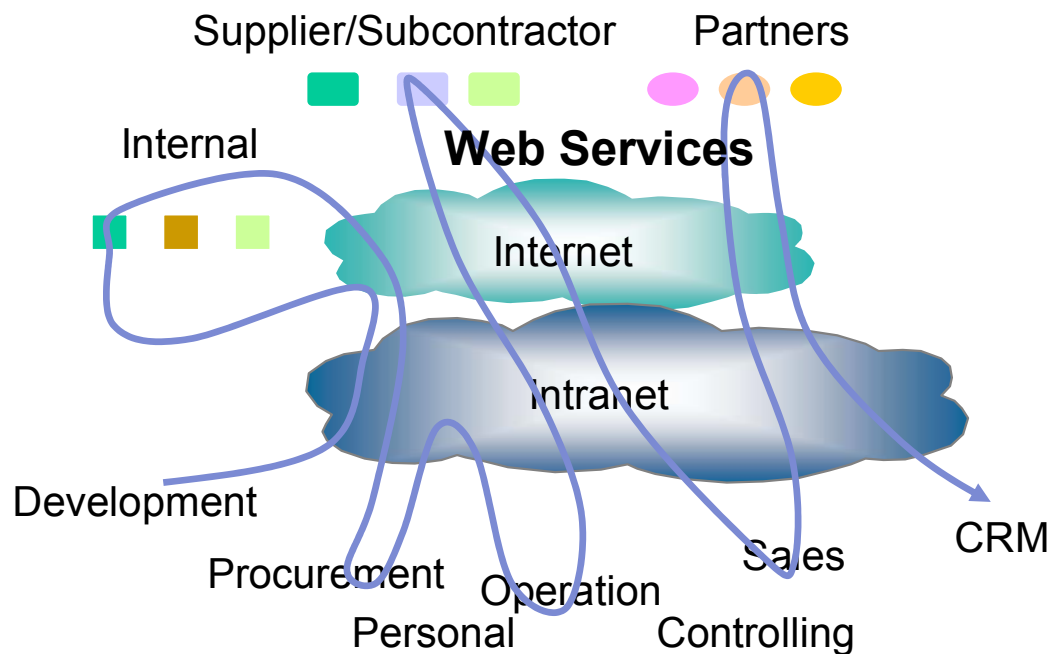

Process Support

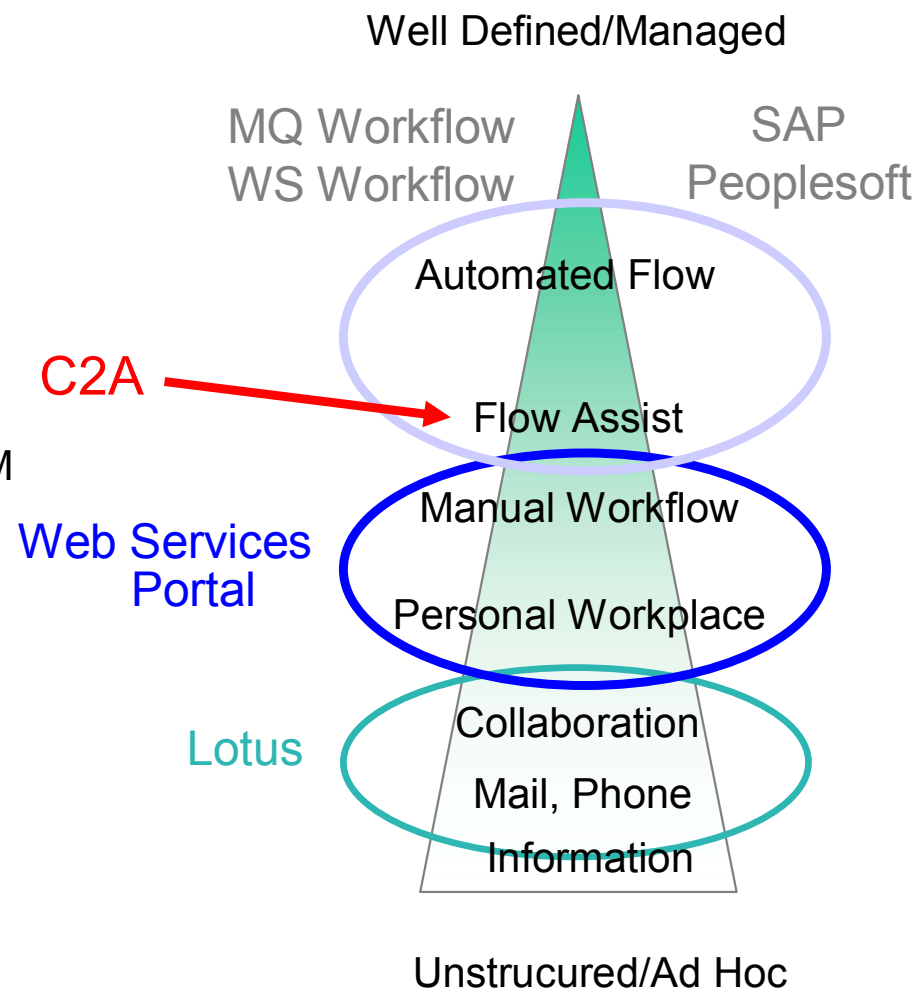

- **System must support**
 - **Internal & external workflows**
 - **User and application administration**
 - **Cross boundary security**

WebSphere Portal - Prinzip

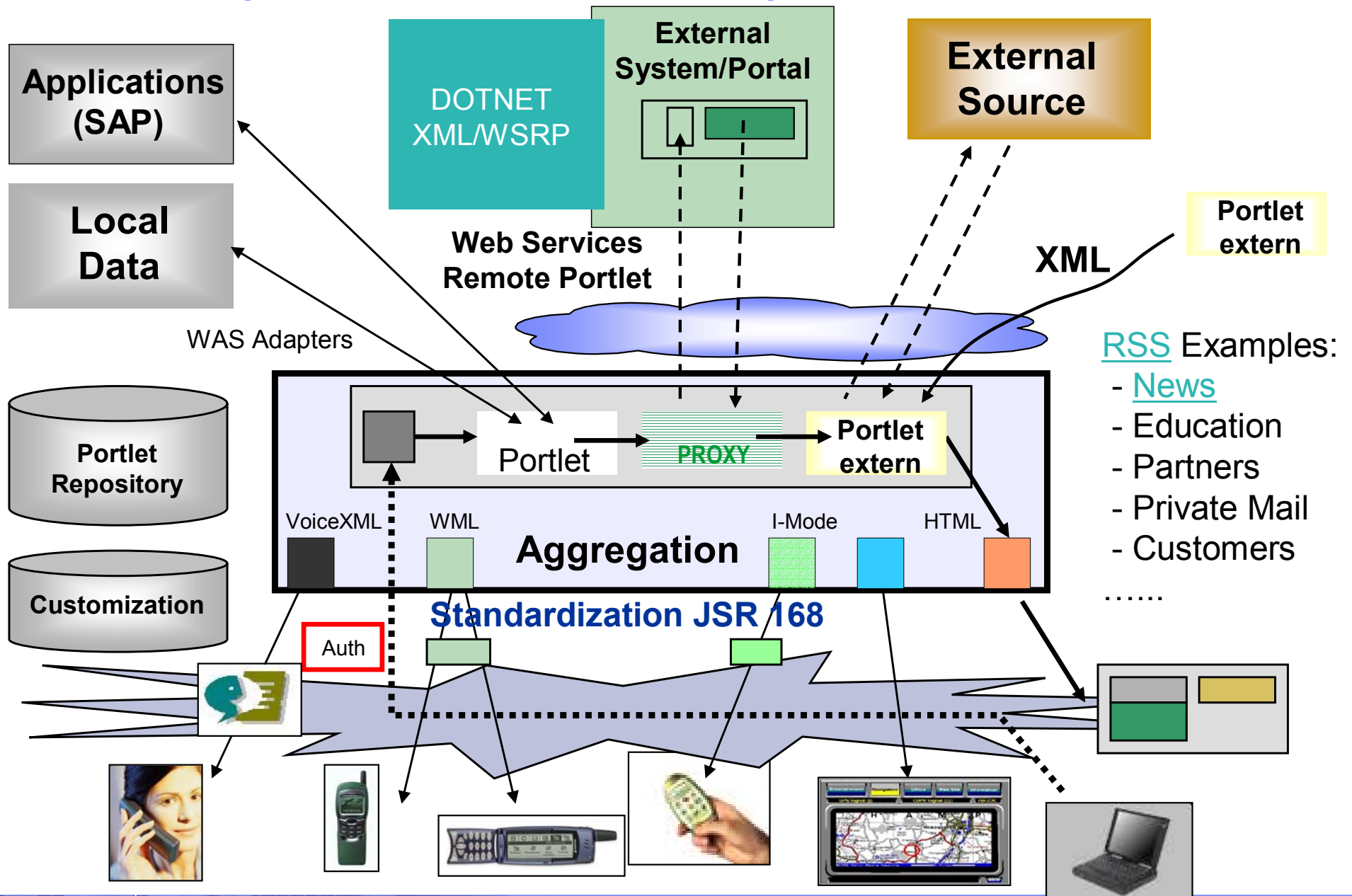

Portal Standards

- JSR 168 Portal Framework
 - A framework for development of portlets and integration into portals
 - Co Chairman: Stefan Hepper
 - <http://www.jcp.org/aboutJava/communityprocess/final/jsr168/>
The Apache Software Foundation, Art Technology Group, BEA, Boeing, Borland, BroadVision, Citrix, EDS, Epicentric, Fujitsu Limited, Hitachi, IBM, Novell, Oracle, SAP, SAS Institute, Sun, Sybase, TIBCO
 - Leading US Universities moving to JSR168 www.uportal.org
- Web Services Remote Portal (OASIS)
 - www.oasis-open.org/committees/tc_home.php?wg_abbrev=wsrp
 - Committee: BEA, Bowstreet, CA, Epicentric, Fujitsu, IBM, Novell, Oracle, Plumtree, SAP, Sun, TIBCO, WebCollage
 - Approver: Microsoft, Novell, CITRIX, Vignette
 - Chairman: Thomas Schaeck

- [WSRP Demo Site](#)
(Open Source Group)

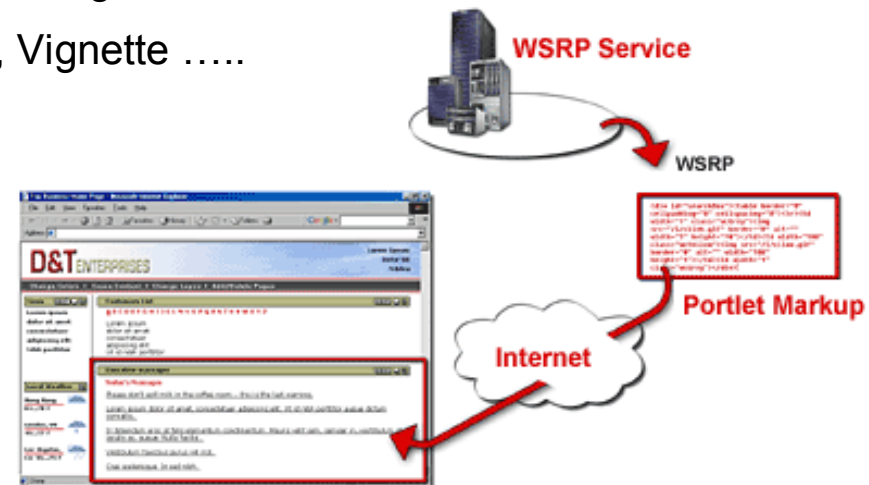

Virtuelle Portale: eine Plattform viele logische Portale

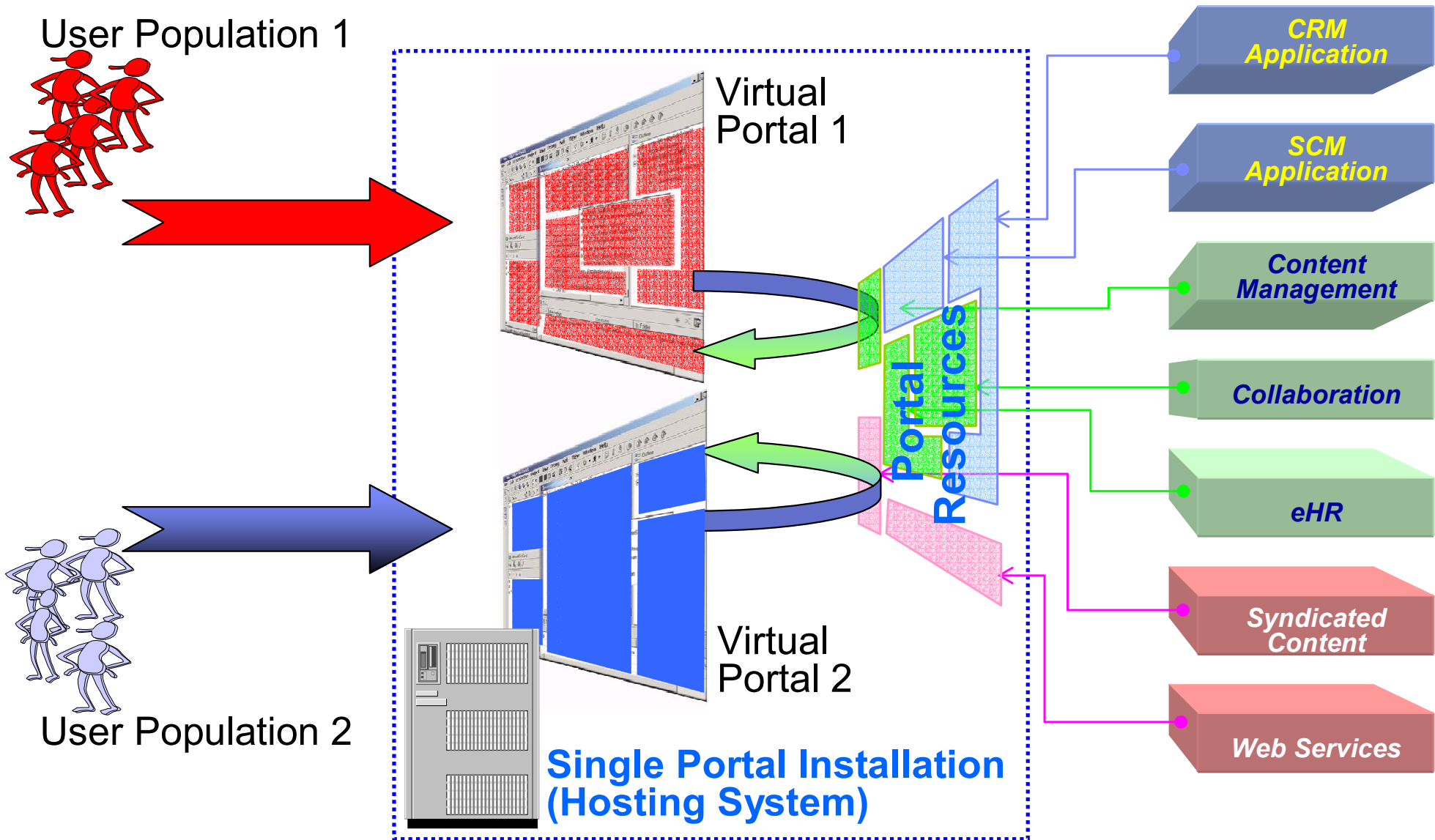

Administration – Sicherheit – Authorisierung - Delegation

- Built-in authorization system
 - stores information in the database
 - protects page groups, pages, portlets
 - determines what users can see and do in the portal
 - grants view, edit, manage rights to individual users or groups

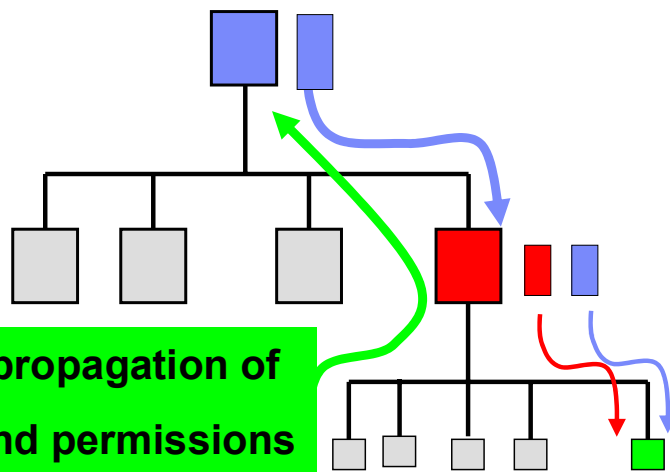

Upward propagation of
Rights and permissions

WPS 5.0

Name	Inherited access				Individual access				
	View	Edit	Manage	Delegate	None	View	Edit	Manage	Delegate
Select All:					<input type="radio"/>	<input type="radio"/>	<input type="radio"/>	<input type="radio"/>	<input type="checkbox"/>
Home	<input checked="" type="checkbox"/>				<input type="radio"/>	<input type="radio"/>	<input type="radio"/>	<input type="radio"/>	<input type="checkbox"/>
Page 1		<input checked="" type="checkbox"/>		<input checked="" type="checkbox"/>	<input type="radio"/>	<input type="radio"/>	<input type="radio"/>	<input type="radio"/>	<input type="checkbox"/>
Page 2		<input checked="" type="checkbox"/>		<input checked="" type="checkbox"/>	<input type="radio"/>	<input type="radio"/>	<input type="radio"/>	<input type="radio"/>	<input type="checkbox"/>
Page 3			<input checked="" type="checkbox"/>		<input type="radio"/>	<input type="radio"/>	<input type="radio"/>	<input type="radio"/>	<input type="checkbox"/>
Home Pages					<input type="radio"/>	<input type="radio"/>	<input type="radio"/>	<input type="radio"/>	<input type="checkbox"/>
Page x					<input type="radio"/>	<input type="radio"/>	<input type="radio"/>	<input type="radio"/>	<input type="checkbox"/>
Page y					<input type="radio"/>	<input type="radio"/>	<input type="radio"/>	<input type="radio"/>	<input type="checkbox"/>
Page Z					<input type="radio"/>	<input type="radio"/>	<input type="radio"/>	<input type="radio"/>	<input type="checkbox"/>
IBM Home	<input checked="" type="checkbox"/>				<input type="radio"/>	<input type="radio"/>	<input type="radio"/>	<input type="radio"/>	<input type="checkbox"/>
Software	<input checked="" type="checkbox"/>				<input type="radio"/>	<input type="radio"/>	<input type="radio"/>	<input type="radio"/>	<input type="checkbox"/>

Authorisation along

Organization
Location
Product Line
Role, Team

Portal Sicherheitsinfrastruktur – Single Sign On

- Zugriff auf eine Vielzahl von Anwendungen mit einem **AUSWEIS**
 - UID und Passwort
 - Digitales Zertifikat in SW oder HW
- Einsatz der Digitalen Signatur

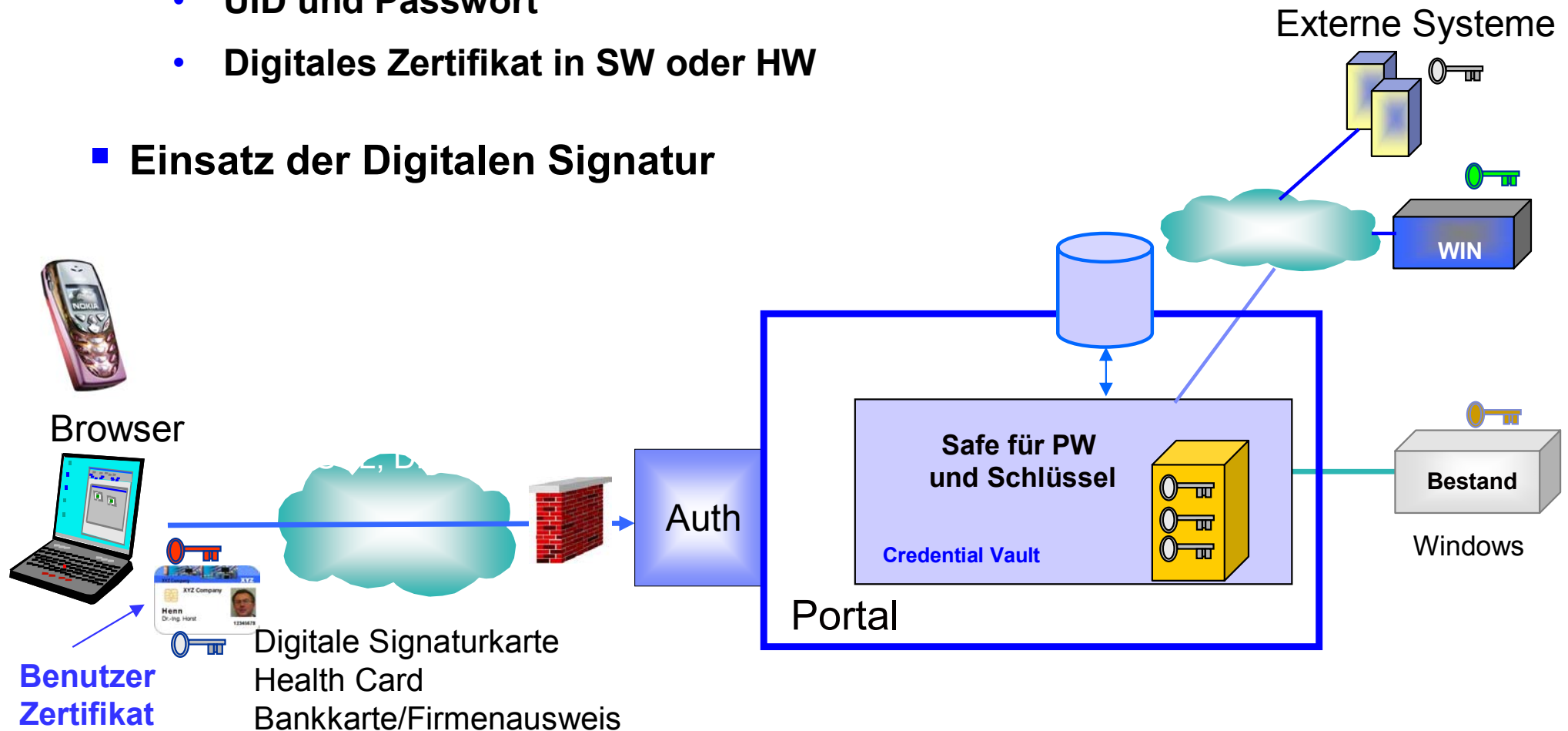

Portal zur Unterstützung der Zusammenarbeit

IBM WebSphere Portal - Microsoft Internet Explorer

File Edit View Favorites Tools Help

Address http://wps61.boeblingen.de.ibm.com/wps/myportal!lut/pj.cmd/cs/ce/7_0_A/s7_0_S5/s_7_0_A/7_0_S5

Google wps/portal university Web-Suche PageRank Site-Popups zulässig Optionen wps portal university

WebSphere Portal Welcome **Horst Henn!** My Portal ? Log ou

Welcome Applications Collaboration Center Documents Our Customers My Work AP EMEA US My Favorites

Information Portlet Collaboration Center

Collaboration Center

This is the Portal connection to the classic Domino, Sametime, and Quickplace environments. Use **Lotus Web Conferencing** to set up and use Web meetings. Use **My Lotus Team Workplace** to work with the Quickplaces on the workplace. **Sametime Contact List** provides the Sametime functionality within the PortalPortal community. **Who Is Here** displays all users which are active on the Collaboration Center page. **People Finder** allows you to search users within the bluepages user directory.

Lotus Web Conferencing

+ New Meeting

Find a meeting that is:

In Progress

Webmeeting

Show All

Search by meeting name or moderator:

Go

For an unlisted meeting, enter the entire meeting name.

My Lotus Team Workplaces

Refresh

Search my workplaces:

Go

Advanced Search

Arbeitsplätze

My Workplaces

Title	Last Modified
Everybody Sells	10/22/04
BettinaPlace	10/15/04
Bundestag	10/11/04
portalecosystem	10/11/04

People Finder

Search by:

Name

Search for:

Go

Advanced Search

Who Is Here

Show people here: 1

Sametime Contact List

People Options

Work

- Horst Henn
- Wolfgang Sieber
- Bettina Bludau
- Martin Welsch
- Travis Smith
- Dirk Wittkopp
- Michael Renner
- Rene Schuler
- Stefan Liesche
- Peter Libal
- Kay Baumgartel

Kooperation im Team

Technische Unterstützung und Administration

Address http://wps61.boeblingen.de.ibm.com/wps/myportal/tut/pl_s.7_0_A/7_0_BQE/.cmd/ad/.ar/sa.1370064051/.c/6_0_7MV/.ce/7_0_BQH/.p/5_0_B7H/.d/1?PC_7_0_BQH_fname=1370064051.html#7_0_BQH Go

Google wps/portal university Web-Suche PageRank Site-Popups zulässig Optionen wps portal university

WebSphere Portal Welcome **Horst Henn!** My Portal ? Log

Welcome Applications Collaboration Center Documents Our Customers My Work AP EMEA US My Favorites

CMVC ASO eAMT ebay L3 Support WebSphere Portal Product Support Solution Broker Portal Configuration Wizard

L3 Knowledge Database Viewer

Taken from PMR 05833,021,724

As noted in the pmr above. Were going to need a HeapDump to determined were the memory leak could be. The following can assist you in obtaining that information.

If the output of "java -fullversion" returns a build prior to SR3 (build 20020828), javacores and heapdumps are buffered. The default buffer size is 512 KB. This default buffer size will cause javacores and heapdumps that are larger than 512KB to be truncated.

How do I tell if I am running a build of a JDK that buffers javacore and heapdump output?

A. Windows

From the C: \WebSphere\Appserver\java directory, issue the following command:

```
java -fullversion
```

The output will look something like this:

```
java full version "J2RE 1.3.1 IBM Windows 32 build cn131w-20020710 ORB130"
```

B. AIX

From the AIX: /usr/WebSphere/AppServer/java/jre/bin directory, issue the following command:

```
./java -fullversion
```

The output will look something like this:

```
java full version "J2RE 1.3.1 IBM AIX build ca131w-20030103 ORB130"
```

How do I override the default buffer setting of 512KB?

A. Windows

Add the following lines to the top of the adminserver.bat file in the

- WPS Support
 - Contacts
 - Version Specifics
 - Tips & Tricks
 - Encoding URL's in Portlets
 - ErrorNotLoggedOut
 - Http Traces
 - WPS & iSeries
 - JavaScript und H* Infomation
 - Debugging
 - NativeHeap Mem
 - Leaks on WIndows
 - URL invalid: Missing parameter ".ciid"
 - WMM
 - Documentation
 - Custom Login Theme
 - Disable Sametime Code
 - PUMA API
 - SSL Setup & login redirects
 - CMVC Explorer
 - Copyright Classes
 - LDAP Password compare

Team Arbeitsplätze

Portal Ecosystem - External Community - portalecosystem - Microsoft Internet Explorer

File Edit View Favorites Tools Help

Back Forward Stop Home Search Favorites Media Refresh Mail Print

Address http://wps40.boeblingen.de.ibm.com/QuickPlace/portalecosystem/Main.nsf/h_Toc/4DF38292D748069D0525670800167212/?OpenDocument Go

Google Web-Suche PageRank Site-Popups zulässig Optionen

portalecosystem Home

■ Horst Henn | New... Edit Check Out... Copy Move Delete

- Portal Community
- Repository Notify Print
- Repository Overview
- Repository Details
- Portal Ecosystem - External Community
- Discussion
- Documents
- Calendar
- Tasks
- Index
- Customize
- Members
- Chat
- Search
- What's New
- Work Offline
- My Places
- Help

Portal Ecosystem



Welcome

This is the Welcome Page of the Portal Ecosystem Community. The members of the community are IBM professionals, customers, researchers and people interested in the promotion and application of the portal user interface and system paradigm: systems should be built according to individual user requirements and not to the requirements of a 'typical' user. **One size does not fit all!** Users should be able to customize their view to the IT and real world according to their need and ability.

A Portal Ecosystem consists not only of software and hardware but also of people, groups and communities but also systems and real world objects interacting with each other in an environment suited for cooperation and innovation. Value is created mainly by cooperation and integration of existing systems and organisations. Thus systems adhering to the portal principles can be built on top of the existing infrastructure.

The portal ecosystem community is started as a local community in the Stuttgart, Germany area in order to test the approach. However, it is intended to create a series of local interest groups and finally a world wide cooperative community supporting a wide variety of environments.

At an initial meeting in the IBM Lab Boeblingen the Stuttgart PORTALECO team decided to focus initially on three areas

- 1) Manufacturing and Facility Management (in order to support the local automotive industry DaimlerChrysler, Porsche and their suppliers as well as local communities)
Chair: Prof. Fetzer, FHTE Esllingen
- 2) Entertainment and Event Infrastructure for Soccer World Championship 2006
Chair: M. Augspach, CIO Stuttgarter Strassenbahnen AG (SSB)
- 3) Social and Health including community portals
Chair: H. Henn IBM

This team space is used as a central place for communication of the IBM internal community. An external portal will be created soon for external communication and cooperation between the portal ecosystem community.

Team Space Owner: H. Henn, WebSphere Portal Development (hhenn@de.ibm.com)
Created: May 5th, 2004 Last Update:

Forschungsportal Erlangen-Nürnberg

Kompetenzzentrum Portale - Microsoft Internet Explorer

Address: http://portal.wiso.uni-erlangen.de/wps/portal

Suche:

MyPortal
News & Events

forwin
FAU Erlangen-Nürnberg
Wirtschaftsinformatik III

JSP Server
Willkommen im Portal zum Thema Portal Engineering & Management.

In diesem Portal finden Sie Artikel, News, Events, Diskussionsbeiträge sowie Verweise zu Büchern und weiterführenden Seiten zu allen Themen rund um das Portal Engineering & Management.

Zentrale Themen sind:

- [Portaltypen](#)
- [Portalprojekte](#)
- [Portal-Engineering](#)
- [Portalmanagement](#)
- [Entwicklungen und Trends](#)

Eine Einführung über diese Themen finden Sie direkt unter [Überblick](#)

Top- & Neue Artikel

Top-Artikel

Titel	Hits	Rating
1. Profitable Prozesse durch prozessorientierte Content- und Kanalintegration - Beispiel Telekommunikation [pdf]	152	★★★★★
2. Enterprise Portals - Business Case für Portale [pdf]	151	★★★★
3. Prozessorientierte Wirtschaftlichkeitsbetrachtung von Unternehmensportalen [www]	129	★★★★★

Neue Artikel

Titel	Hits	Rating
1. Prozessorientierte Wirtschaftlichkeitsbetrachtung von Unternehmensportalen [www]	129	★★★★★
2. Profitable Prozesse durch prozessorientierte Content- und Kanalintegration - Beispiel Telekommunikation [pdf]	152	★★★★★

JSP Server Participation
Wir suchen weiterhin Kooperationspartner aus dem universitären Umfeld sowie aus der Wirtschaft um unser Angebot auszuweiten und zu verbessern. Gerne möchten wir auch im Bereich der Forschung und Entwicklung mit weiteren Partnern zusammenarbeiten. Für weitere Informationen stehen wir Ihnen gerne zur Verfügung.

Aktuelle News

2004-06-01 Bei Portalen entscheiden die Details
Portale haben sich in der IT-Landschaft etabliert. Orientierungshilfen bei der Produktauswahl gibt e ... [mehr...]

2004-05-24 WebSphere Portal 5.0 wins eWEEK's Excellence Award for Portals
WebSphere Portal Server has won eWEEK's Excellence Award for Portals and Knowledge Management. The a ... [mehr...]

2004-05-24 IBM Workplace - Innovations for People Productivity
Join us for IBM Workplace: Innovations for People Productivity and learn how IBM Software can provid ... [mehr...]

Events-Kalender

Newsletter
E-Mail:
 Monatliche News
 Monatliche Events

Voting
Wie beurteilen Sie unser Forschungsportal?
★★★★★

Top-User

Name	Anzahl Ratings
1. alexander.schmid	74
2. shota.okujava	42
3. SNG	17
4. steffen.moeller	12
5. gurzki	11

* Ranking nach Anzahl der durch einen User bewerteten Beiträge

Statistik

Content-Typ	Anzahl Einträge
Artikel	121
Links	11
Literatur	16
Aktuelle News	0
Events	44
Systeme	228

Top-Literatur*

Marktübersicht Portal Software für Business-, Enterprise- Portale un

Wissensportal für die Region

Address <http://www.ntht.org/wps/portal> Go

Google wps/portal university Web-Suche PageRank 332 blockiert Optionen wps portal university

October 25, 2004 I forgot my password Sign up ? Log

NORTHERN TIER
High Technology Corridor

Home Collaborate Education Business

Welcome About the NTHT News

What happened to all my communities?
All of your communities are still here on the Northern Tier, most have been moved to the "Collaborate" section. Once you log in and click on the "Collaborate" tab, you will be able to see all of your Public and Private communities, as well as the Collaboration Center, which will allow you to do online meetings, search for people on the Northern Tier, and allow you to search all of your Communities all on one page.

What The Northern Tier offers

- The ability to collaborate using discussion forums and instant messaging.
- The ability to find Economic Development Resources including organizations and individuals.
- Searchable database of "experts" in multiple fields with the ability to collaborate online.
- A place to bring your idea to fruition.



Why we Exist

- To increase the economic vitality of the region by providing the necessary tools to collaborate and bring together organizations and individuals.
- Market regional knowledge and technology resources.
- Identify strategic opportunities to strengthen Rural Minnesota through Collaboration
- Help YOU succeed!

The Northern Tier brings together economic development organizations, business, industry, and non-profit agencies to maximize the efficiency and range of services available to rural businesses and Knowledge Clusters. The Northern Tier provides the collaborative tools necessary to link business and industry with the knowledge resources they need to succeed. To make this possible, the economic development organizations of Rural Minnesota are working together to offer a comprehensive suite of services to ensure the success of rural businesses.

Quick Tools

Instant Collaboration Tools... ..

[Instant Messaging](#) is now available! Communicate in real time with members of your team. You must [Log in](#) to participate.

Research Tools... ..

- [Minnesota Technology](#)
- [University of Minnesota Research Portal](#)
- [Natural Resources Research Portal](#)
- [Agriculture Utilization research Institute](#)

Resources

- Click on the tabs above to collaborate with experts specific to your industry or,
- Click on the navigational bar on the left to find physical resources, links to economic development and business statistics, and access to higher education resources.

Regional Economic Development Initiatives... ..

Community Portal

October 25, 2004

[I forgot my password](#) | [Sign up](#) ? | [Log](#)

[Home](#)
[Collaborate](#)
[Education](#)
[Business](#)
[Public Communities](#)

[Covey](#)
[North Shore Trade & Tech.](#)
[North West SBDC](#)
[Minnesota SBDC](#)
[Improving Communities](#)
[Itasca Housing](#)
[Housing](#)
[Festival Park](#)
[I.T. Link North](#)
[Website Marketing](#)
[Northland Tech.](#)
[Consortium](#)

Improving Communities

[Sign In](#)

Welcome
Growth Management
Discussion
Library:
Calendar
Tasks
Index
Search
What's New
My Places
Help

[Home](#)
[Print](#)

Welcome

Welcome to the Improving Communities forum. This forum provides a place for people to converse and exchange ideas concerning all aspects of community development.

You must sign in to participate. If you already have a user name, click "**Log In**" in the upper right hand corner. If you do not have a user name, click on "**Register**" in the upper right hand corner.

To join a discussion area, just click on [Discussion](#) to the left. The [Library](#) contains information that may be of interest to community development planners or other people interested in making their community a better place to live. If you are interested in adding content to the [Library](#), contact [Tim Flathers](mailto:tflathers@hrdc.org), tflathers@hrdc.org or [Joe Czapiewski](mailto:jczapiewski@hrdc.org), jczapiewski@hrdc.org, or call the HRDC at (218) 444-4732.

To learn more about using this forum, click the **Tutorial** or **Help** link to the left. Please e-mail hrdc@hrdc.org with any questions, comments, or suggestions.

Next steps

- > Click any link in the table of contents to start working
- > Click [Help](#) for more information

Report any problems to the Northern Tier Administrator at kwilliams@bemidjistate.edu or 218-755-4900

Address http://www.aofoundation.org/portal/wps/portal/!ut/p/.cmd/cs/.ce/7_0_A/.s/7_0_J2/.s.7_0_A/7_0_J2

Google Web-Suche PageRank 332 blockiert Optionen wps portal u

AO Foundation Log in Search: go

[Home](#) • [Contact](#) • [Feedback](#) • [Jobs](#) • [Legal](#)

AO World	AO Academy	Surgery	Clinical studies	Research	Innovations
News	About AO Foundation	Structure & organization	Activities	Networking	

Archive

Newsmail

Arbeitsgemeinschaft Schweiz

AO News archive

print this page 

Browse through a selection of older news articles dating back to year 2000. This is not a comprehensive listing, but a collection of articles of general interest or of relevance to our portal's visitors.



2004-09-08

Article of the month

This article of the month is a publication by the AO Research Institute, which was published in the latest Spine Journal Volume 29, Nr. 17. The topic of the publication is: Biomechanical Analysis of Transpedicular Screw Fixation in the Subaxial Cervical Spine.

[more](#)

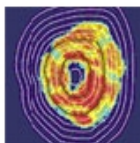

2004-08-11

Article of the month

The latest list of the projects funded 2004 by the AO Research Fund is online. Take a look at the abstracts of the projects.

[more](#)



2004-07-14

Keita Ito appointed new President of the European Society of Biomechanics

In the context of the 14th Congress of the ESB, which took place in the

Industrie Arbeitsgemeinschaft

SEMI: Semiconductor, MEMS & FPD Industry Information - Microsoft Internet Explorer

File Edit View Favorites Tools Help

Back Forward Stop Home Search Favorites Media

Address http://wps2a.semi.org/wps/portal/_pagr/103

Google wps/portal university Web-Suche PageRank 332 blockiert Optionen wps portal university

About SEMI Contact Us Site Map

Home Advocacy Events Communities Products & Services News & Resources Technology & Standards Membership

Portal Sign-In

Username:

Password:

[Submit]

New User Forgot Password

Search semi.org

[Search]

Other semi.org Searches

Search SEMI Members

Search SEMI Standards

Page Features

Email this Page

Language Preference:

English

SEMI Help

Download Standards

Register, Login and Site Help

SEMI FAQ

Click for IBM Mark meaning and disclaimers. IBM and e-business Mark are TM's of IBM Corp.

Free Technical Events

Mentor Graphics

[Online Tutorials](#)

[Hands-On Workshops](#)

[Seminars & Industry Events](#)

Register Today!

SEMI NANOFORUM 2004

November 14-17
Austin, Texas

SEMI Highlights

SEMICON Japan 2004

December 1-3, 2004
Makuhari Messe (Nippon Convention Center)
Tokyo, Japan

SEMI Membership Directory

Search SEMI OneSource

SEMI OneSource is the industry's premier global directory of suppliers, containing information about SEMI member companies and their products and services.

To find suppliers and product information, click here.

To list your products in OneSource, [click here](#). See SEMI OneSource **featured products**.

Industry Events Calendar

Displaying 1-15 out of 40 [MORE]

Date	Title
Oct 24-28 2004	NA Standards Autumn Meetings 2004
Oct 27-29 2004	Key Semiconductor Account Selling and Management
Oct 28-29 2004	European Summit: Expanded Europe - New Market Opportunities and Challenges
Oct 29 2004	e-Manufacturing - Interface A Workshop

31st Annual Forecast and SEMI Award Recipients

The award recognizes visionary leaders whose long-time commitment and contributions to the semiconductor equipment and materials industry have helped shape global commerce and the development of information technology.

SEMI NanoForum 2004

November 14-17, 2004
Hilton Austin Hotel
Austin, Texas
New Opportunities, Experienced Voices, Practical Solutions

September 2004 SEMI Book-to-Bill is 0.96

Bookings and billings reported by North American headquartered semiconductor equipment manufacturers were \$1.36 billion and \$1.42 billion, respectively, with the SEMI Book-to-Bill ratio at 0.96 for September.

Download now. Subscribe now!

Industry News

Veeco hits lowered quarter targets, plans to cut expenses by 10%

Bildungsportal

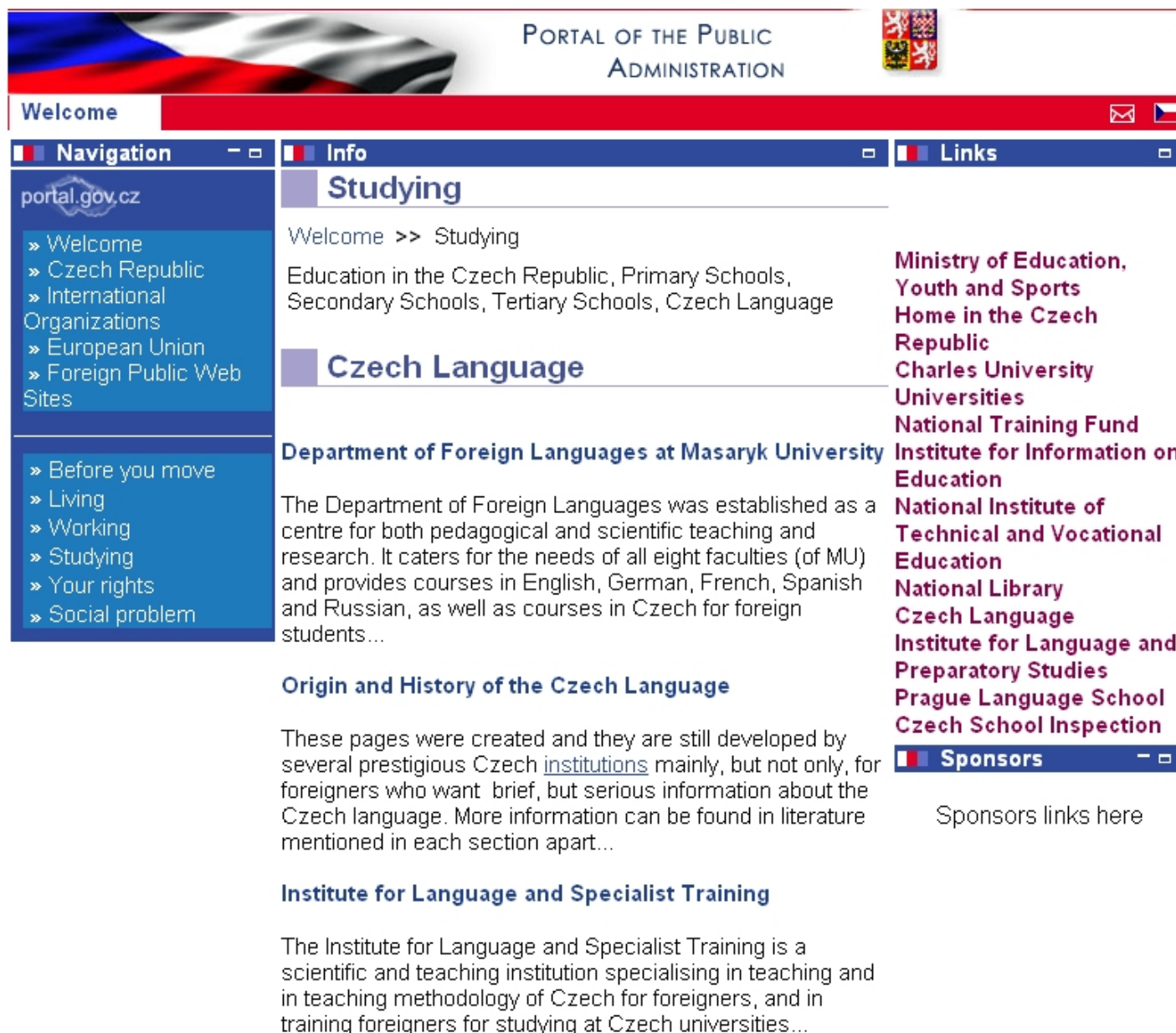

The screenshot shows a web portal with a header featuring the Czech flag and the text "PORTAL OF THE PUBLIC ADMINISTRATION". Below the header is a red "Welcome" bar with an email icon and a Czech flag icon. The main content area is divided into three columns:

- Navigation:** A blue sidebar with a search box and a list of links: Welcome, Czech Republic, International Organizations, European Union, Foreign Public Web Sites, Before you move, Living, Working, Studying, Your rights, and Social problem.
- Info:** The main content area, currently displaying "Studying" and "Czech Language" sections. The "Studying" section includes a breadcrumb "Welcome >> Studying" and text about education in the Czech Republic. The "Czech Language" section is titled "Department of Foreign Languages at Masaryk University" and describes the department's role in teaching and research.
- Links:** A list of external links including: Ministry of Education, Youth and Sports; Home in the Czech Republic; Charles University; Universities; National Training Fund; Institute for Information on Education; National Institute of Technical and Vocational Education; National Library; Czech Language; Institute for Language and Preparatory Studies; Prague Language School; and Czech School Inspection.

At the bottom of the "Info" section, there is a sub-section titled "Origin and History of the Czech Language" with text explaining that the pages were created and developed by several prestigious Czech institutions. Below this is another sub-section titled "Institute for Language and Specialist Training" with text describing its scientific and teaching focus.

On the right side, there is a "Sponsors" section with a link "Sponsors links here".

Universitätsnetzwerk www.uportal.org



Evolving portal implementations from
participating universities & partners

JA-SIG Home

About uPortal

FAQ

Download

Documentation

Getting Involved

Code Repository

Reporting Bugs

License

Meetings

uPortal is a free, sharable portal under development by institutions of higher-education. This group sees an institutional portal as an abridged and customized version of the institutional Web presence... a "pocket-sized" version of the campus Web. Portal technology adds "customization" and "community" to the campus Web presence. Customization allows each user to define a unique and personal view of the campus Web. Community tools, such as chat, forums, survey, and so on, build relationships among campus constituencies.

uPortal is an open-standard effort using Java, XML, JSP and J2EE. It is a collaborative development project with the effort shared among several of the JA-SIG member institutions. You may download *uPortal* and use it on your site at no cost.

NEWS

- **Punahou portal builds K12 community**
by Wendi Takemoto, Punahou School
- **uPortal 2.3.5 and 2.4 now available.**
- **uPortal Developers Meeting** held August 30-31, 2004 at Massachusetts Institute of Technology [Meeting Minutes]
- **uPortal Summer Conference**
June 20-22, 2004, Denver, Colorado
- **"Combating Stovepipes: Implementing Workflow in uPortal"**
By Mark Askren and Marina Arseniev
- **uPortal partners with Sakai, recipient of \$2.5 million Mellon Grant**
- **uPortal Training** -- upcoming classes from Unicon:
[Advanced UC Berkeley](#) October 26-28, 2004 [Details](#)
- **uPortal in InfoWorld Top 5**
[uPortal is No. 4 in InfoWorld magazine's Top 100 IT Projects of 2003 \(PDF\).](#)

uPortal in Production

- Alexandria Technical College
- Appalachian State University
- Arizona Department of Education
- Arizona State University
- Athabasca University
- California Polytechnic State University (tour)
- California Department of Education
- Cedarville University
- Columbia University
- Cornell University
- Dalhousie University
- DeMonford University
- Denison University
- Duke University
- Edmonton Public School Board
- El Camino Community College
- Fullerton College
- Hanoi Information Portal
- Ho Chi Minh City IT Project Office
- Hong Kong University of Science and Technology
- iAssessment
- Illinois State University (tour)
- Indiana Department of Education
- instructional media and magic
- Juniata College
- LaSalle University
- Laurentian University
- Lehigh University
- Los Angeles Unified School District
- Memorial University of Newfoundland
- Millersville University
- Nagoya University
- New Jersey Institute of Technology
- Northeastern University
- Northern Arizona University
- Plymouth State University

Funded by a grant from
The
Andrew W. Mellon
Foundation



Universitäts Portal

Learning Center - Microsoft Internet Explorer

File Edit View Favorites Tools Help

Back Forward Stop Home Search Favorites Media

Address <http://discoverypark.e-enterprise.purdue.edu/wps/portal/.cmd/cs/.ce/155/.s/4364/.s.155/4364> Go

Google wps/portal university Web-Suche PageRank 332 blockiert Optionen wps portal university

PURDUE UNIVERSITY **Discovery Park** October 25, 2004 - 7:50

Overview Nanotechnology Bioscience e-Enterprise Entrepreneurship **Learning Center** CAM Search All Discovery Park

Navigation

- Home
- Center News
- Services for Researchers
- Resources for Educators
- Projects and Proposals
- Assessment & Evaluation
- Become an Affiliate
- Contact Us

User Login

User Name
 Password

Login New User

Purdue University Links

Contact the DLC
765-494-0608
[Purdue Homepage](#)
[Purdue Search](#)
[Campus Map](#)
[Purdue Directories](#)
[VPR](#)

Learning Center Feedback

Name
 E-Mail

Comments:

Discovery Learning Center
Exploring futuristic technologies and strategies for teaching excellence.



Discovery Learning Center Home



Welcome to the Discovery Learning Center

Discovery Park will be known locally and nationally as a place where cutting-edge, world-class interdisciplinary work will be conducted. The Learning Center in Discovery Park focuses on learning and bringing together teachers, learners, and researchers to explore new, sometimes futuristic technologies, pedagogies, and strategies relevant to the learning environment.

Since its inception in March 2003, Discover Learning Center has focused on identifying, developing, and nurturing interdisciplinary teams and projects that integrate, synthesize, and promote discovery, learning, and engagement. Currently, the Learning Center has over 300 Affiliates representing twelve schools and 45 academic departments or units at Purdue; plus affiliates from other Universities, Business and Industry, Teachers, Professional Organizations,

Interns for Indiana Program

The Interns for Indiana program (If at Purdue University, funded through the Lilly Endowment, seeks innovative ways to keep Indiana's college graduates in Indiana. By placing high quality student interns with start-up companies, Purdue hopes to accelerate company growth, while providing students with valuable educational experiences.

The Interns for Indiana program offers students a unique opportunity to learn about the business world through a combination of education and experience. Through a seminar series and other activities, students will explore entrepreneurial issues and skills, have opportunities to network and develop as a community, and earn up to 2 academic credits. In addition, participating students will be eligible for placement in a paid internship with a start-up company. DLC is currently seeking interested students and companies.

If your company is interested in the Interns for Indiana program please contact the IfI staff for more information (kstobias@purdue.edu).

The student fall selection process is closed. Students interested in applying for the 2005 spring and summer semesters must submit completed application along with the required materials (see the Student Information link) by December 8th, 2004.

External Information & Services

News feeds (RSS)

Wiki (pedia)

Blogs

Jams

Search

Information Services

Self Services

The screenshot shows a web browser window displaying the Louisiana.gov website. The address bar shows the URL: http://www.louisiana.gov/wps/portal/.cmd/cs/.ce/155/.s/3313/_s.155/1133. The browser's search bar contains the text "Web-Suche". The page header features the "Louisiana.gov" logo and the tagline "The official Web site of the State of Louisiana". The main content area is titled "Louisiana Demographics: Census Data Center" and includes sections for "Louisiana Census Facts Application", "Frequently Visited Links", "State Census Data Center Local Affiliates", and "Census and Other Information Sites". A left sidebar contains a navigation menu with categories like "Louisiana.gov", "Home", "Contacts", "Serving The Public", "Travel and Recreation", "Business in Louisiana", "Learning in Louisiana", "Louisiana Government", "About Louisiana", "Just For Students", "History and Culture", "Events", "How's The Weather?", "Other Government Services", "Demographics: Census Info", "Population Estimates", "Geography", "Economic Statistics", "Demographic Profiles", "Census 2000 Information", "American Factfinder Census Information", "Census Announcements and Notifications", "Income and Poverty Estimates", "Census Geography", "Louisiana Demographic Map Images", "Census 2000 Release schedule", "U.S. Census subjects", "U.S. Census 2000 Overview", "LEAP: Parish Profiles", "LA Statistical Abstract", "Health statistics", "Labor Market Information", "Rural Parish definitions, Office of Rural Health", "Shreveport-Bossier Economic Indicators", "Census Data Products Catalog", "Dallas Regional Census Office", "State Data Center Clearinghouse", and "Consumer Price Index".

Address http://www.louisiana.gov/wps/portal/.cmd/cs/.ce/155/.s/3313/_s.155/1133

Google Web-Suche PageRank 332 blockiert Optionen

Louisiana.gov
The official Web site of the State of Louisiana

Louisiana Demographics: Census Data Center

Louisiana Census Facts Application
Easy Access to Zip Code, Census Tract, Congressional District, Metro Area, Block Group, and Block Information in Louisiana Census Facts:
[Demographic Profiles](#) [Social and Economic Profiles](#)

Frequently Visited Links

- › [Louisiana Census 2000 Information](#)
- › [New Circular Area Profiles\(CAPS\)Application](#)
Aggregates Socio-economic data to circular areas for point or radii
- › [Population Estimates and Projections](#)
- › [Demographic Profiles and Rankings](#)
- › [Historic Decennial Census Publications](#)
- › [Demographic Profiles and Rankings](#)
- › [Census 2000 state Counts](#)
- › [U.S. Census Data Maps and Profiles](#)
- › [U.S. Census Tract street Locator](#)
- › [American Factfinder Census Information](#)
- › [Census Announcements and Notifications](#)
- › [Income and Poverty Estimates](#)
- › [Census Geography](#)
- › [Louisiana Demographic Map Images](#)
- › [Census 2000 Release schedule](#)
- › [U.S. Census subjects](#)
- › [U.S. Census 2000 Overview](#)

State Census Data Center Local Affiliates

- › [Louisiana Database Catalog](#)
- › [LSU Population Data Center](#)
- › [Greater New Orleans Inc.](#)
- › [Labor Force Information](#)
- › [LA Atlas GIS site](#)
- › [Greater New Orleans Community Data Center](#)
- › [LEAP: Parish Profiles](#)
- › [LA Statistical Abstract](#)
- › [Health statistics](#)
- › [Labor Market Information](#)
- › [Rural Parish definitions, Office of Rural Health](#)
- › [Shreveport-Bossier Economic Indicators](#)

Census and Other Information Sites

- › [U.S. Census Bureau](#)
- › [Census 1990 Block Data Online](#)
- › [Census 1990 Data Lookup for All states](#)
- › [Age search service](#)
- › [Census Data Products Catalog](#)
- › [Dallas Regional Census Office](#)
- › [State Data Center Clearinghouse](#)
- › [Consumer Price Index](#)

Portalnetzwerk für Deutschland

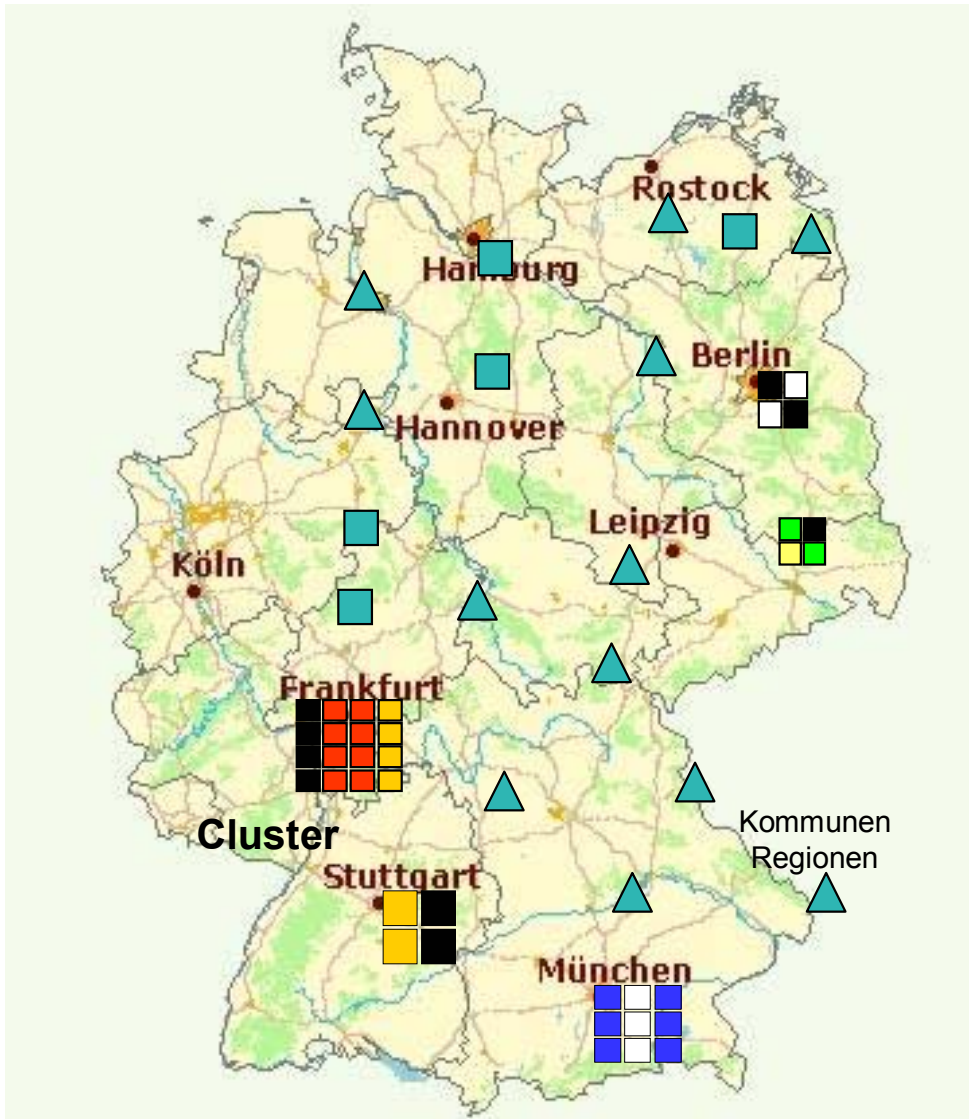

■ Kooperationsnetzwerk Deutschland

- Infrastruktur für Bürger
- Bund, Länder, Gemeinden
- Universitäten, Bibliotheken
- Selbstverwaltung auf mehreren Ebenen
- Gemeinsame Sicherheitskonzepte
- Regionale und lokale Subportale
- Individuelle, verteilte Erstellung der Inhalte und Applikationen
- Globale und kontrollierte Nutzung der Daten und Anwendung
- Dienstleistungen für Unternehmen und Bürger
- Basierend auf offenen Standards und Vielzahl von Anbietern
- Startpunkte
- ...

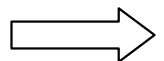

Thank You – Questions?



hhenn@de.ibm.com

System Evolution

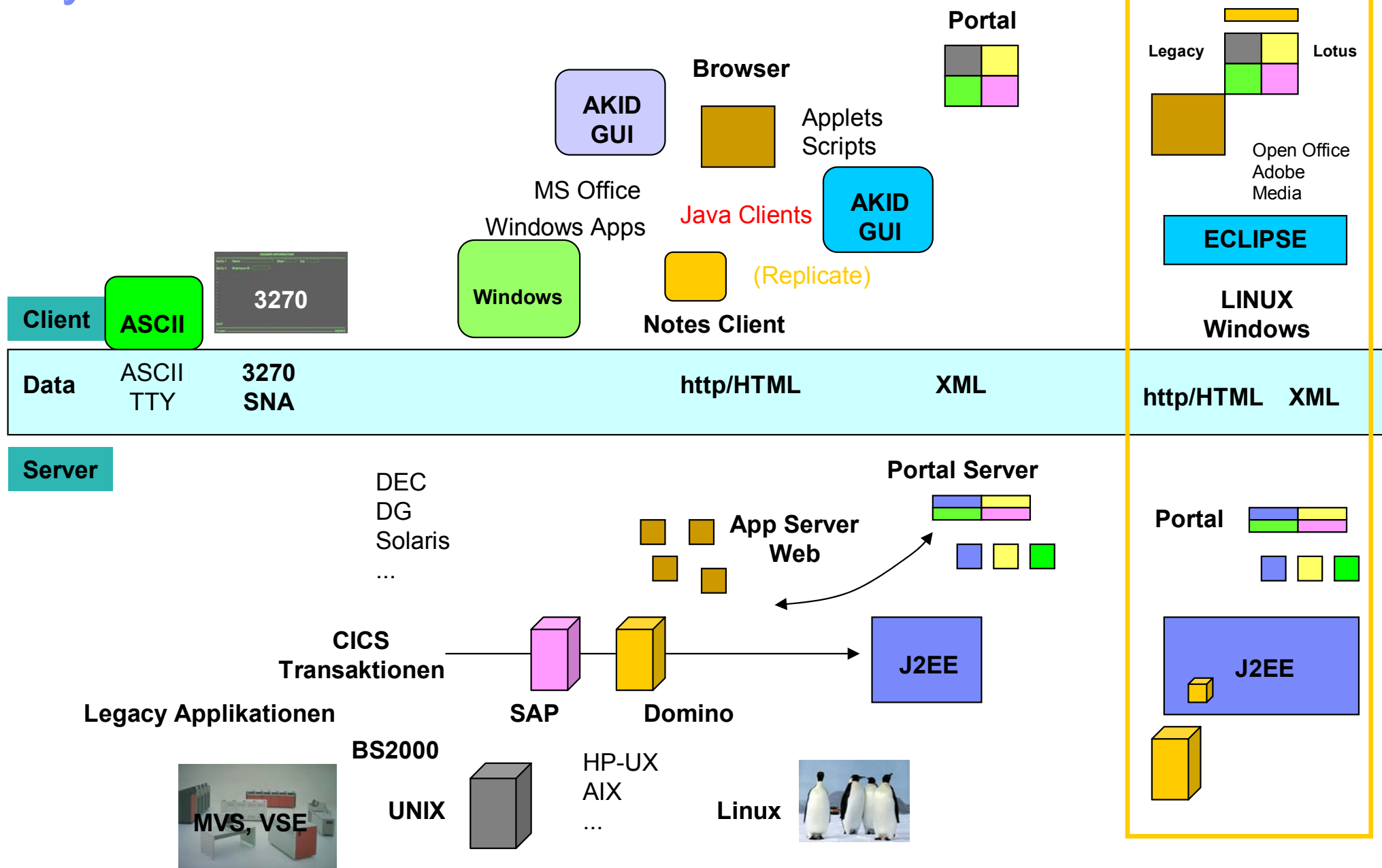

Portal und Lotus Workplace Entwicklung

IBM WebSphere Portal - Microsoft Internet Explorer

Address: http://wps61.boeblingen.de.ibm.com/wps/myportal/!ut/p/s_7_0_A/7_0_6Q/.cmd/ad/ar/ja/spf_ActionListener/.c/6_0_46/.ce/7_0_83H/.p/5_0_7JQ/.d/0?PC_7_0_83H_spf_strutsAction=%212fdisplayMessageHeaders.do%213fserverGroup%3Dnew: Go

WebSphere Portal Welcome **Horst Henn!** My Portal ? Log

Navigation: Welcome Applications Collaboration Center Documents Our Customers My Work AP EMEA US My Favorites

Information Portal V5

Welcome to **Portal Portal**. This is the **portal** for WebSphere **Portal** Developers. Use your IBM Intranet user ID and password for access. **Note:** To enable your IBM Intranet user ID and password, use the registration portlet on this page. If you have any feedback comments, please send them to [Wolfgang Sieber](#).

Regional Offices:

- Boeblingen** (Image)
- Haifa** (Image)
- Raleigh** (Image)
- Sydney** (Image)
- Westford** (Image)

Red Labels:

- Foundation** (under Boeblingen)
- Search** (under Haifa)
- Product** (under Raleigh)
- Content Mgmt** (under Sydney)
- Lotus Workplace** (under Westford)

Right Side Text:

- Research
- China
- Austin
-
- Partner

News Menu: Patty's news menu

Newsgroups: Select a different newsgroup

Subject	Posted by	Last post	Replies
how can i do this?	jjd228@NOSPA...	9/13/04	1
struts & messaging portlets	mantis713@co...	9/11/04	0
2 Portals: WSRP Portlet doesn't work	Tino Drohula	9/10/04	0
Themes	gaurav99	9/9/04	2
PortletModes	Christian Peder...	9/8/04	0
Aqain: 20.000 users in LDAP a problem?	Silvain Piree	9/13/04	3
Lotus Workplace 2.0 install	Jon Mell	9/6/04	0
about lwcm's setup question	wps_zk	9/6/04	0
Authorization for user wpsadmin failed	Chemi	9/6/04	5
get Family Name	Vasil Yaroshevich	9/3/04	0

World Clock: Local Time: 5:48 PM Brussels, Berlin, Bern - 9/14/04

Time Zone	Local Time
Pacific Time (US & Canada)	8:48 AM (9/14/04)
Mountain Time (US & Canada)	9:48 AM (9/14/04)
Central Time (US & Canada)	10:48 AM (9/14/04)
Eastern Time (US & Canada)	11:48 AM (9/14/04)
Brussels, Berlin, Bern	5:48 PM (9/14/04)
Israel	6:48 PM (9/14/04)
Canberra, Melbourne, Sydney	1:48 AM (9/15/04)

Quick Search: [input field]

Portlets: RegisterIntranetUser portlet, About WebSphere Portal, ClusteringDemo portlet

Themen heute

- Portal Grundlagen
- Beispiele für Portale – Universitäten, Arbeitsgruppen, Bildung

Beispiel: Workplace für Minijob Sachbearbeiter

Erinnerung

Links

Midi Job rechner

Minijob Zentrale

Mail zu Minijobs